

May 13, 2022 (Revision #3)

Chairperson Kevin Conero
Village of Montgomery Planning Board
133 Clinton Street
Montgomery, NY 12549

RE: KSH Development LLC, Proposed Warehouse and Office Development, NYS Route 211 (a.k.a. Union Street), Village of Montgomery, Orange County, New York; CM Project No. 119-036

Dear Mr. Conero,

Creighton Manning Engineering, LLP (CM) has completed a revised Traffic Impact Study for the proposed warehouse development located on NYS Route 211 in the Village of Montgomery. Revisions were made based on comments made by the New York State Department of Transportation (NYSDOT) in an email dated January 21, 2022, which is included under Attachment A. The study herein evaluates traffic impacts based on the Sketch Plan, prepared by Engineering & Surveying Properties, PC (ESP), which is included under Attachment B, as well as industry-standard traffic engineering guidelines.

1.0 Project Description

The site is located on the west side of NYS Route 211 between Weaver Street and Chandler Lane. The proposed project consists of two stand-alone 60,000-square-foot warehouses and two stand-alone 80,000-square-foot warehouses. The site will be supported by a total of 266 parking spaces consisting 126 parking spaces for warehouse use and 140 parking spaces for office use in the warehouse. The primary access point to the site will be a full-movement driveway on NYS Route 211 aligned with Chandler Lane, which will be designed to accommodate both passenger vehicles and trucks (including tractor trailers). An emergency access driveway is proposed on NYS Route 211 approximately 450 feet south of Weaver Street. The proposed project is expected to be completed and occupied by 2025. A map illustrating the project location and adjacent roadway network is shown on Exhibit 1.



Exhibit 1 – Site Location

2.0 Existing Conditions

Roadways Serving the Site and Surrounding Area

NYS Route 211 (Union Street) is an Urban Minor Arterial and is under the jurisdiction of the New York State Department of Transportation (NYSDOT). The roadway generally runs east and west connecting US Route 209 to NYS Route 17K passing through the city of Middletown, but runs north and south in the vicinity of the project site in the Village of Montgomery. The roadway provides one travel lane and a paved shoulder in each direction in the vicinity of the project site. The posted speed limit is 30 miles per hour. Land uses along NYS Route 211 are a mix of commercial, residential, and institutional. Montgomery Elementary School is located approximately 1,750 feet north of project site across from River Street and Saint Mary’s Catholic Church is located approximately 3,200 feet north of the project site just south of Boyd Street. Sidewalk on the west side of the roadway begins immediately north of the site.

NYS Route 17K (Ward Street) is an Urban Minor Arterial and is under the jurisdiction of the NYSDOT. The roadway runs east and west connecting Bloomingburg in Sullivan County with Newburgh in Orange County. In the vicinity of NYS Route 211, NYS Route 17K provides one travel lane and a paved shoulder in each direction. The posted speed limit is 30 miles per hour. Land uses along NYS Route 17K are a mix of commercial and residential. Sidewalks are provided.

NYS Route 416 is an Urban Major Collector and is under the jurisdiction of the NYSDOT. The roadway runs north and south from NYS Route 207 to NYS Route 211. NYS Route 416 provides one travel lane and a variable-width paved shoulder in each direction. The posted speed limit is 55 miles per hour. Land uses along NYS Route 416 are residential, commercial, and agricultural. Sidewalks are not provided along this roadway.

Study Area Intersections

- **NYS Route 17K and NY Route 211:** This is a four-leg intersection operating under traffic signal control on three legs (eastbound, westbound, northbound) and stop control on the southbound (private driveway) approach. All approaches provide one shared movement lane. There are crosswalks on the westbound and southbound approaches, but no pedestrian signals or push buttons. The Google Earth image to the right depicts this intersection.
- **NYS Route 211, River Street, and Montgomery Elementary School Access Driveway:** This is an offset four-leg unsignalized intersection operating with stop control on the eastbound River Street approach. All approaches provide one shared movement lane. There are crosswalks on the eastbound, northbound, and southbound approaches. The Google Earth image to the right depicts this intersection.

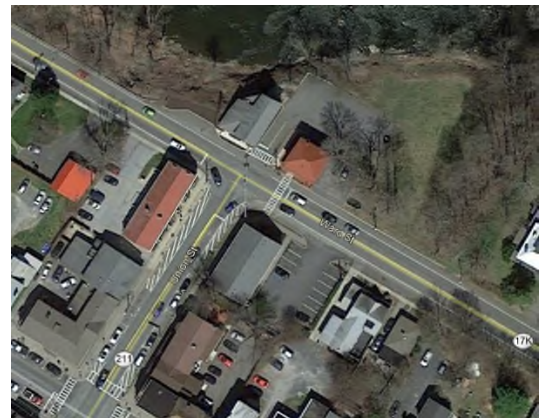

- NYS Route 211 and Chandler Lane:** This is a three-leg unsignalized intersection operating with stop control on the westbound Chandler Lane approach. All approaches are accommodated by one shared movement lane. The Google Earth image to the right depicts this intersection.



- NYS Route 211 and NYS Route 416:** This is a three-leg unsignalized intersection operating with control on the northbound NYS Route 416 approach. Northbound traffic on NYS Route 416 turning right onto NYS Route 211 is accommodated by a one-way channelized roadway under yield control, while traffic making a left-turn is stop controlled. The northeastbound and southwestbound approaches of NYS Route 211 provide one shared lane for through movements and turns. The Google Earth image to the right depicts this intersection.



Transit, Pedestrians, and Bicyclists

Coach USA/Shortline provides commuter bus service within the Montgomery area. The nearest commuter railroad station to the subject site is Campbell Hall on the Port Jervis Line of the Metro-North Railroad, approximately 6 miles away. There are crosswalks at the NYS Route 211/NY Route 17K and NYS Route 211/River Street/School Access Driveway intersection, but no pedestrian signals. Pedestrian and bicyclist activity on NYS Route 211 is summarized in Table 1.

Table 1 – Pedestrian and Bicyclist Count

Intersection w/ NYS Route 211	Weekday AM Peak Hour		Weekday PM Peak Hour	
	Pedestrians	Bicyclists	Pedestrians	Bicyclists
NYS Route 17K	4	0	8	0
River Street/School Access Driveway	12	0	8	3
Chandler Lane	0	0	1	0
NYS Route 416	0	0	0	0

Data Collection

Turning movement counts were conducted on June 05, 2019, during the weekday morning peak period from 7:00 to 9:00 a.m. and weekday evening peak period from 4:00 to 6:00 p.m. These periods coincide with peak operating conditions of the proposed development, as well as adjacent street traffic. It is important to note that schools were in normal session. The counts were performed at the following intersections:

- NYS Route 211 and NYS Route 17K
- NYS Route 211, River Street, and the School Access Driveway
- NYS Route 211 and Chandler Lane
- NYS Route 211 and NYS Route 416

The traffic volumes for the AM and PM peak hours shown on Figure 1 provide base year 2019 conditions and form the basis for all traffic forecasts. The raw turning movement count data is included under Attachment B.

3.0 Traffic Assessment

Trip Generation – Proposed Conditions

As previously stated, the proposed development consists of two stand-alone 60,000-square-foot warehouses and two stand-alone 80,000-square-foot warehouses. Trip generation determines the quantity of traffic expected to travel to/from a given site. The Institute of Transportation Engineers’ (ITE) *Trip Generation Manual*, 11th Edition, is the industry-standard resource for estimating trip generation for proposed land uses based on data collected at similar uses. Specifically, ITE Land Use 150 “Warehousing” was cited. Table 2 summarizes the potential trip generation for the weekday AM and weekday PM peak hours.

Table 2 – Trip Generation Summary

Land Use	Weekday AM Peak Hour			Weekday PM Peak Hour		
	Enter	Exit	Total	Enter	Exit	Total
Warehousing – 60,000 SF	24	7	31	9	25	34
Warehousing – 60,000 SF	24	7	31	9	25	34
Warehousing – 80,000 SF	25	8	33	10	26	36
Warehousing – 80,000 SF	25	8	33	10	26	36
Total Trips	98	30	128	38	102	140
Total Passenger Vehicle Trips	96	26	122	34	98	132
Total Truck Trips	2	4	6	4	4	8

It is important to note that there is no “pass-by” component of the traffic associated with the proposed warehouse/office development. Table 2 shows that the development is expected to generate 128 total trips during the weekday morning peak hour and 140 total trips during the weekday evening peak hour. Since these trips will be distributed throughout the roadway network, the trip increase at a single intersection or on a single approach is expected to be less.

Future Traffic Volumes

To evaluate the impact of the proposed development, traffic projections were prepared for the expected year of completion—2025. In order to forecast the 2025 traffic volumes, a 1.0% growth rate was applied to the 2019 existing traffic volumes and compounded annually for six years. Additionally, in consultation with the Town of Montgomery and Village of Montgomery, CM identified ongoing development projects that, if approved and constructed, could potentially increase traffic within the study area. Table 3 summarizes the other planned development projects that are directly considered in this analysis.

Table 3 – Other Planned Development Projects

Project	Type	Location	Size	Source of Trip Generation
Medline	Warehouse/distribution center	494 Route 416	1,295,557 SF	Kimley-Horn
DoltBest	Warehouse/distribution center	650 Neelytown Rd	Parking for 53 additional employees	Town of Montgomery
City Winery ¹	Special event venue	Factory St	350-seat catering facility, winery/distillery, 10-15 hotel rooms	Maser Consulting
Devitt Chandler Lane PDD ²	Mixed use (residential, office/retail)	Chandler La, NY Route 211	165 condos (mix of attached and detached), 66,000 SF office/retail	Engineering & Surveying Properties
19 – Unit Multifamily	Residential	Railroad Place	19 units	11 th Edition ITE
4-Unit Multifamily with First Floor Retail	Mixed use	99 Clinton Avenue	4 units	11 th Edition ITE
8-Unit Multifamily with First Floor Retail	Mixed use	Clinton Avenue	8 units	11 th Edition ITE
134 Neelytown	Warehousing	134 Neelytown Road	312,500 SF	11 th Edition ITE
Cardinal Health Expansion	Warehousing	500 Neelytown Rd	309,094 SF	11 th Edition ITE
United Natural Foods Inc. Expansion	Warehousing	525 Neelytown Road	165,093 SF	11 th Edition ITE
RDM Warehouse	Warehousing	Neelytown Road	692,000 SF and 214,000 SF	11 th Edition ITE

¹The traffic impact study performed by Maser Consulting for the City Winery development project indicates that the project is not expected to generate trips during the AM peak hour of this analysis. Therefore, only the Friday PM peak hour volumes generated by the City Winery development have been accounted for in this analysis.

²The traffic study for the Devitt Chandler Lane PDD project does not represent the current site plan and proposed land uses. Therefore, an approximate trip generation, distribution and assignment were performed for this project based on the most recent site information provided by the applicant (which included 43 detached condos, 122 semi-attached condos, and 66 KSF of office space) in order to assess the worst-case 2025 No-Build traffic conditions at the study area intersections.

The anticipated traffic generated by other developments is shown on Figure 2. These volumes were then added to the grown traffic volumes in order to develop the forecasted 2025 No-Build traffic volumes shown on Figure 3, which represent the forecasted traffic volumes in 2025 *without* the proposed warehouse and office development project on NYS Route 211.

Traffic generated by the proposed project was distributed to the adjacent roadways based on existing observed travel patterns in the project area and the probable travel routes of truck drivers and employees. The proximity of the subject site to I-84, the City of Middletown, and the City of Newburgh are expected to influence the trip-making behavior of vehicle operators. The primary trip distribution pattern for the proposed development is shown on Figures 4A and 4B. The associated site-generated traffic volumes are shown on Figure 5 (for warehousing passenger vehicles) and Figure 6 (for warehousing trucks). The site-generated trips were then added to the 2025 No-Build traffic volumes, resulting in the 2025 Build traffic volumes shown on Figure 7.

Traffic Operations

Intersection Level of Service (LOS) and capacity analysis relate traffic volumes to the physical characteristics of an intersection. Intersection evaluations were made using Synchro 11 software which automates the procedures contained in the *Highway Capacity Manual*. Table 4 summarizes the results of the level of service calculations for the proposed project. The detailed level of service analyses are included under Attachment C.

Table 4 – Level of Service Summary

Intersection	Control	AM Peak Hour			PM Peak Hour		
		2019 Existing	2025 No-Build	2025 Build	2019 Existing	2025 No-Build	2025 Build
NYS Route 211/NYS Route 17K	S						
NYS Route 17K EB LTR		A (9.1)	B (10.3)	A (8.7)	B (12.7)	B (15.6)	B (15.7)
NYS Route 17K WB LTR		A (6.7)	B (10.6)	B (15.8)	C (20.8)	D (45.9)	E (60.9)
NYS Route 211 NB LTR		C (23.3)	D (49.7)	F (92.6)	D (40.6)	F (82.8)	F (112.3)
NYS Route 211 SB LTR		B (17.3)	B (18.9)	C (22.9)	B (17.5)	B (19.0)	B (19.0)
Total		B (10.7)	B (17.0)	C (24.7)	C (24.5)	D (48.8)	E (65.2)
NYS Route 211/River St/School Access	U						
River St EB LTR		B (14.9)	C (17.3)	C (18.8)	C (17.8)	C (22.2)	C (24.3)
School Access WB LTR		B (12.8)	B (14.5)	C (15.5)	B (11.7)	B (12.7)	B (13.2)
NYS Route 211 NB LTR		A (8.3)	A (8.5)	A (8.7)	A (7.9)	A (8.1)	A (8.1)
NYS Route 211 SB LTR		A (7.7)	A (7.9)	A (7.9)	A (0.0)	A (0.0)	A (0.0)
NYS Route 211/Site Drwy/Chandler Lane	U						
Site Warehouse Driveway EB [LTR]		--	--	C (17.6)	--	--	D (25.0)
Chandler Lane WB LTR		B (14.2)	C (15.5)	C (22.3)	C (16.4)	C (22.3)	D (30.4)
NYS Route 211 NB [L]TR		--	--	A (8.8)	--	--	A (8.1)
NYS Route 211 SB LTR		A (8.2)	A (8.4)	A (8.1)	A (8.8)	A (9.3)	A (9.1)
NYS Route 211/NYS Route 416	U						
NYS Route 416 WB L		C (24.3)	E (38.3)	E (42.8)	C (17.6)	D (25.3)	D (27.1)
R		A (9.4)	B (10.1)	B (10.4)	B (13.0)	C (15.7)	C (15.6)
NYS Route 211 SB LT		A (8.0)	A (8.3)	A (8.5)	A (8.4)	A (8.8)	A (8.9)

U = Unsignalized intersection

EB, WB, NB, SB = Eastbound, Westbound, Northbound, and Southbound intersection approaches

L, T, R = Left-turn, Through, and/or Right-turn movements

X (Y.Y) = Level of service (Average delay in seconds per vehicle)

The impact of the project can be described by comparing the analysis of the No-Build and Build operating conditions. The following observations are evident from this analysis:

- NYS Route 211/NYS Route 17K:** This intersection presently operates at an overall LOS B/C during the AM and PM peak hours, respectively. In the No-Build condition, the overall level of service changes from a C to a D in the PM peak hour with the northbound NYS Route 211 and westbound NYS Route 17K approaches experiencing the most notable increases in delay. Without improvements to the signal, these delays are exacerbated in the Build condition. **According to NYSDOT Regional Traffic Signal Engineer, Maureen Kuinlan, the signal is currently undergoing improvements that will benefit its operation. CM requested the proposed signal timing improvements from Ms. Kuinlan in October 2021, but were informed that those timings have not been finalized as of the date of this report. Therefore the Build 2025 LOS results presented above reflect the existing and soon-to-be-outdated traffic signal timing parameters. It is expected that the NYSDOT's ongoing improvements will result in better operating levels as compared to those presented herein.**
- NYS Route 211/River Street/School Access Driveway:** The movements of this intersection operate from LOS A to C. The only changes to level of service are a change from the River Street eastbound movement from LOS B to C during the AM peak hour between the Existing and No-Build condition, and a change from the School Access Driveway westbound movement from a LOS B to C during the AM peak hour between the No-Build and Build condition.
- NYS Route 211/Chandler Lane/Site Driveway:** The eastbound site driveway will operate at LOS C during both the weekday AM peak hour and a LOS D in the weekday PM peak hour. During the AM peak hour Build condition the westbound Chandler Lane approach changes from LOS B to C. During the PM peak hour Build condition the westbound Chandler Lane approach changes from LOS C to D.

- NYS Route 211/NYS Route 416:** This intersection currently operates between LOS A and C during both peak hours. During the AM peak hour in the No-Build condition, the NYS Route 416 approach left-turn lane changes from LOS C to E, and the right-turn slip lane changes from LOS A to B. During the PM peak hour in the No-Build condition, the NYS Route 416 approach the right-turn slip lane changes from LOS B to C during the No-Build condition. These Levels of Service are maintained in the Build Condition, with the exception of the NYS Route 416 approach left-turn lane changing from a LOS C to D in the PM peak hour.

Traffic Signal Warrant Analysis

An analysis was conducted to determine if the No-Build or Build traffic volumes warrant the installation of a traffic signal at the intersection of NYS Route 211, Chandler Lane, and the Site Driveway. The traffic conditions and physical characteristics of the intersection were correlated to the signal warrant criteria contained in the 2009 National *Manual on Uniform Traffic Control Devices* (National MUTCD), published by the Federal Highway Administration (FHWA). The National MUTCD specifies the minimum criteria that must be met in order for a traffic signal to be justified. The satisfaction of a signal warrant in itself is not necessarily justification for a traffic signal. Other engineering and operational factors must be considered. The National MUTCD contains nine warrants, three of which were determined to be applicable and were evaluated in detail:

- Warrant 1 – Eight-Hour Vehicular Volume** - This warrant is satisfied if for any eight hours of an average day the traffic volumes for Condition A or Condition B specified in Table 4C-1 of the National MUTCD are met for the main arterial and the higher volume side road approach to the intersection.
- Warrant 2 – Four-Hour Vehicular Volume** - This warrant is met when for any four hours of an average day, points plotted on the graph presented on Figure 4C-2 of the National MUTCD fall above the appropriate curve.
- Warrant 3 – Peak Hour** - This warrant is met when for any one hour of an average day, points plotted on the graph presented on Figure 4C-4 of the National MUTCD fall above the appropriate curve.

Table 5 summarizes the warrant analyses based on the No Build traffic volumes at the intersection for Warrants 1, 2, and 3. Table 6 summarizes the warrant analyses based on the Build traffic volumes associated with the proposed development. A “Yes” under the “Signal Warrants Met?” column indicates that the criteria are satisfied for that hour. The detailed evaluation for both scenarios for Warrants 1, 2, and 3 is included under Attachment D.

Table 5 – Traffic Signal Warrant Analysis of NYS Route 211/ Site Driveway/Chandler Lane (No-Build)

Time Begin (1-hour period)	No-Build Volumes		Signal Warrants Met?			
	NYS Route 211	Chandler Lane	#1		#2	#3
			Cond. A	Cond. B		
6:00 AM	293	40	No	No	No	No
7:00 AM	406	65	No	No	No	No
8:00 AM	431	75	No	No	No	No
9:00 AM	413	77	No	No	No	No
10:00 AM	418	89	No	No	No	No
11:00 AM	472	99	No	No	No	No
12:00 PM	544	109	Yes	Yes	No	No
1:00 PM	519	101	No	No	No	No
2:00 PM	553	113	Yes	Yes	Yes	No
3:00 PM	594	125	Yes	Yes	Yes	No
4:00 PM	604	125	Yes	Yes	Yes	No
5:00 PM	572	115	Yes	Yes	Yes	No
6:00 PM	461	87	No	No	No	No
7:00 PM	363	73	No	No	No	No
8:00 PM	350	75	No	No	No	No
Required Volumes	One Lane Major Street		350	525	See Figure 4C-2	See Figure 4C-4
	One Lane Minor Street		105	53		
Overall Warrant Met?			No	No	Yes	No

Table 6 – Traffic Signal Warrant Analysis of NYS Route 211/Site Driveway/Chandler Lane (Build)

Time Begin (1-hour period)	Build Volumes			Signal Warrants Met?			
	NYS Route 211	Chandler Lane	Warehousing Site Driveway	#1		#2	#3
				Cond. A	Cond. B		
6:00 AM	317	40	9	No	No	No	No
7:00 AM	427	65	16	No	No	No	No
8:00 AM	451	75	16	No	No	No	No
9:00 AM	443	77	18	No	No	No	No
10:00 AM	438	89	22	No	No	No	No
11:00 AM	498	99	25	No	No	No	No
12:00 PM	572	109	20	Yes	Yes	Yes	No
1:00 PM	541	101	18	No	Yes	No	No
2:00 PM	575	113	18	Yes	Yes	Yes	No
3:00 PM	618	125	30	Yes	Yes	Yes	No
4:00 PM	621	125	25	Yes	Yes	Yes	No
5:00 PM	585	115	22	Yes	Yes	Yes	No
6:00 PM	466	87	13	No	No	No	No
7:00 PM	366	73	4	No	No	No	No
8:00 PM	354	75	3	No	No	No	No
Required Volumes	One Lane Major Street			350	525	See Figure 4C-2	See Figure 4C-4
	One Lane Minor Street			105	53		
Overall Warrant Met?				No	No	Yes	No

Table 5 and Table 6 indicate that Warrants 1 and 3 are not met at the intersection of NYS Route 211, Chandler Lane, the Site Driveway in the No-Build or Build condition. Tables 5 and 6 indicate that the criteria for Warrant 2 are met for a signal in the No-Build and Build condition. However, the Level of Service analysis indicates that all approaches will operate at an acceptable LOS D or better in the No-Build and Build conditions. Therefore, the installation of a traffic signal is not recommended at this location as part of this application.

As requested by the NYSDOT, an analysis was conducted to determine if the No-Build or Build traffic volumes warrant the installation of a traffic signal at the intersection of NYS Route 211 and NYS Route 416. The traffic conditions and physical characteristics of the intersection were correlated to the signal warrant criteria contained in the 2009 National *Manual on Uniform Traffic Control Devices* (National MUTCD), published by the Federal Highway Administration (FHWA). The National MUTCD specifies the minimum criteria that must be met in order for a traffic signal to be justified. The satisfaction of a signal warrant in itself is not necessarily justification for a traffic signal. Other engineering and operational factors must be considered. The National MUTCD contains nine warrants, three of which were determined to be applicable and were evaluated in detail:

- Warrant 1 – Eight-Hour Vehicular Volume - This warrant is satisfied if for any eight hours of an average day the traffic volumes for Condition A or Condition B specified in Table 4C-1 of the National MUTCD are met for the main arterial and the higher volume side road approach to the intersection.
- Warrant 2 – Four-Hour Vehicular Volume - This warrant is met when for any four hours of an average day, points plotted on the graph presented on Figure 4C-2 of the National MUTCD fall above the appropriate curve.
- Warrant 3 – Peak Hour - This warrant is met when for any one hour of an average day, points plotted on the graph presented on Figure 4C-4 of the National MUTCD fall above the appropriate curve.

Table 7 summarizes the warrant analyses based on the No Build traffic volumes at the intersection for Warrants 1, 2, and 3. Table 8 summarizes the warrant analyses based on the Build traffic volumes associated with the proposed development. A “Yes” under the “Signal Warrants Met?” column indicates that the criteria are satisfied for that hour. The detailed evaluation for both scenarios for Warrants 1, 2, and 3 is included under Attachment D.

Table 7 – Traffic Signal Warrant Analysis of NYS Route 211/NYS Route 416(No-Build)

Time Begin (1-hour period)	No-Build Volumes		Signal Warrants Met?			
	NYS Route 211	NYS Route 416	#1		#2	#3
			Cond. A	Cond. B		
6:00 AM	233	177	No	No	No	No
7:00 AM	436	296	Yes	No	Yes	No
8:00 AM	520	238	Yes	No	Yes	No
9:00 AM	439	167	Yes	No	No	No
10:00 AM	417	120	No	No	No	No
11:00 AM	445	126	No	No	No	No
12:00 PM	470	135	No	No	No	No
1:00 PM	478	142	Yes	No	No	No
2:00 PM	531	145	Yes	Yes	No	No
3:00 PM	599	178	Yes	Yes	Yes	No
4:00 PM	634	152	Yes	Yes	Yes	No
5:00 PM	607	134	No	Yes	Yes	No
6:00 PM	408	90	No	No	No	No
7:00 PM	301	61	No	No	No	No
8:00 PM	220	54	No	No	No	No
Required Volumes	One Lane Major Street		350	525	See Figure 4C-2	See Figure 4C-4
	One Lane Minor Street		140	70		
Overall Warrant Met?			No	No	Yes	No

Table 8 – Traffic Signal Warrant Analysis of NYS Route 211/NYS Route 416 (Build)

Time Begin (1-hour period)	No-Build Volumes		Signal Warrants Met?			
	NYS Route 211	NYS Route 416	#1		#2	#3
			Cond. A	Cond. B		
6:00 AM	247	184	No	No	No	No
7:00 AM	452	305	Yes	No	Yes	No
8:00 AM	534	245	Yes	Yes	Yes	No
9:00 AM	458	177	Yes	No	No	No
10:00 AM	434	130	No	No	No	No
11:00 AM	465	138	No	No	No	No
12:00 PM	488	144	Yes	No	No	No
1:00 PM	494	150	Yes	No	No	No
2:00 PM	547	154	Yes	Yes	Yes	No
3:00 PM	620	189	Yes	Yes	Yes	No
4:00 PM	652	162	Yes	Yes	Yes	No
5:00 PM	621	141	Yes	Yes	Yes	No
6:00 PM	416	94	No	No	No	No
7:00 PM	304	64	No	No	No	No
8:00 PM	223	57	No	No	No	No
Required Volumes	One Lane Major Street		350	525	See Figure 4C-2	See Figure 4C-4
	One Lane Minor Street		140	70		
Overall Warrant Met?			Yes	No	Yes	No

Table 7 and Table 8 indicate that Warrant 2 is met at the intersection of NYS Route 211 and NYS Route 416. Table 8 indicates that a signal is further warranted based on Warrant 1 Condition A.

Left-Turn Lane Warrant Assessment

A left-turn lane analysis was conducted at the intersection of NYS Route 211, Chandler Lane, and the Site Driveway to determine if the No-Build and/or Build traffic volumes warrant a southbound or northbound left-turn lane into the Chandler Lane/Site Driveway. The opposing, advancing, and left turn volumes were compared to the warrant criteria contained in AASHTO (2018) (see Attachment E). Based on the warrant analyses, a southbound left-turn lane is warranted in No-Build condition based on the background traffic growth and trips generated by the Devitt Chandler Lane project. Likewise, a northbound left-turn lane is warranted in the Build condition for trips associated with the subject development. A concept plan depicting a northbound left-turn lane is included with this report.

4.0 Sight Distance

Available intersection sight distances were measured from the perspective of a vehicle turning into and out of the proposed driveways. The available intersection sight distance on a driveway should provide drivers a sufficient view of the intersecting highway to allow vehicles to enter or exit the intersection without excessively slowing vehicles traveling at or near the operating speed on the intersecting mainline. Stopping sight distance was also measured at the proposed site driveways. Stopping sight distance is the length of the roadway ahead that is visible to the driver. The available stopping sight distance on a roadway should be of sufficient length to enable a vehicle traveling at or near the operating speed to stop before reaching a stationary object in its path. Exhibit 2 illustrates these sight distance measurements.

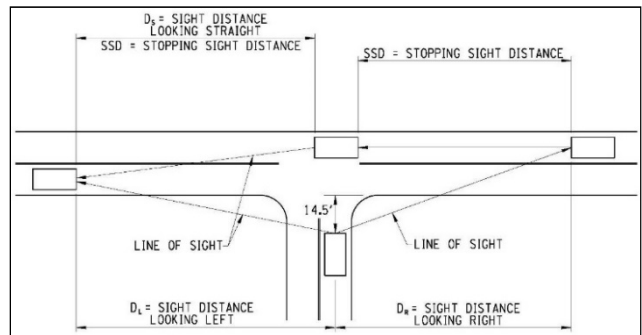

Exhibit 2 – Sight Distance Measurements

The sight distances measured in the field were compared to the guidelines presented in *A Policy on Geometric Design of Highways and Streets, 2011* published by the American Association of State Highway Transportation Officials (AASHTO) and NYSDOT design guidance (EB 17-007) for a 40-mph operating speed northbound and 45-mph southbound. The results of the analysis are summarized in Table 9.

Table 9 – Sight Distance Summary (feet)

Intersection			Intersection Sight Distance ¹				Stopping Sight Distance ²	
			Right-Turn from Site Driveway (D_L)	Left-Turn from Site Driveway		Left-Turn from NYS Route 211 (D_S)	SSD _{NB}	SSD _{SB}
				Looking Left (D_L)	Looking Right (D_R)			
Warehouse Site Driveway	Passenger Vehicles	Available	385 (630)	385 (630)	445	815	750	
		Recommended	430	500	445	365	275	330
	Trucks	Available	255 (835)	255 (835)	1020	815	825	750
		Recommended	695	765	680	500	275	330
Office Site Driveway	Passenger Vehicles	Available	>1000	>1000	500	>1000	375	>1000
		Recommended	430	500	445	365	275	330

¹ Intersection sight distance is measured at 14.5 feet back from the travel way from an eye height of 3.5 feet for a passenger cars and 7.6 feet for trucks to an object height of 3.5 feet.

² Stopping sight distance is measured from an eye height of 3.5 feet for a passenger car to an object height of 2 feet located in the path of eastbound and westbound vehicles.

(xxx) – sight distance if remedial action is taken.

The sight distance analysis indicates the following:

- The available sight distance looking left at the warehousing site driveway does not currently meet the recommended distance for passenger vehicles or trucks due to vegetation as shown in the photos below. Trimming and clearing is recommended to provide sufficient sight lines.



- The available sight distance at the warehousing site driveway for passenger vehicles and truck drivers looking right meets the recommended sight distance.
- The available sight distance for drivers making a left turn into the warehousing site entrance driveway exceeds the recommended sight distance.
- The available intersection sight distance looking to the left and right for drivers exiting the office buildings site driveway exceeds the recommended sight distance.
- The available sight distance for drivers making a left turn into the office buildings site entrance driveway exceeds the recommended sight distance.
- The stopping sight distances for drivers traveling north and south on NYS Route 211 exceeds the recommended sight distance for both driveways.

5.0 Conclusions

The proposed project consists of two stand-alone 60,000-square-foot warehouses and two stand-alone 80,000-square-foot warehouses. The site will be supported by a total of 266 parking spaces consisting 126 parking spaces for warehouse use and 140 parking spaces for office use in the warehouse. The primary access point to the site will be a full-movement driveway on NYS Route 211 aligned with Chandler Lane, which will be designed to accommodate both passenger vehicles and trucks (including tractor trailers). An emergency access driveway is proposed on NYS Route 211 approximately 450 feet south of Weaver Street. The proposed project is expected to be completed and occupied by 2025.

The following is noted regarding the proposed project:

- Based on ITE data, the site is expected to generate 128 trips during the weekday AM peak hour and 140 trips during the weekday PM peak hour.
- Analysis of the proposed unsignalized site driveway demonstrates satisfactory operating levels in the Build Condition.
- The need for a traffic signal and left-turn lanes at the proposed site driveway was evaluated based on MUTCD and AASHTO guidance. A left-turn lane is warranted in the No-Build and Build conditions. The level of service analyses demonstrated that the site driveway will operate satisfactorily without these provisions in the Build Condition.
- Based on the warrant analyses, a southbound left-turn lane is warranted in No-Build condition based on

the background traffic growth and trips generated by the Devitt Chandler Lane project. Likewise, a northbound left-turn lane is warranted in the Build condition for trips associated with the subject development. If implemented, it would be operationally beneficial to mirror this improvement with a northbound left-turn lane at the time of implementation. However, CM recommends that this finding and need for a turn lane be confirmed by that applicant's traffic consultant and the NYSDOT based on the current development plan. If confirmed, the development schedule of each project should dictate when the improvements are implemented.

- The capacity analysis of the study intersections demonstrates that all but the signalized intersection of NYS Route 211 and NYS Route 17K will operate at levels of service commensurate to the No-Build conditions. Capacity constraints experienced at the NYS Route 211/NYS Route 17K intersection are currently being addressed by the NYSDOT. **According to NYSDOT Regional Traffic Signal Engineer, Maureen Kuinlan, the signal is currently undergoing improvements that will benefit its operation. CM requested the proposed signal timing improvements from Ms. Kuinlan in October 2021, but were informed that those timings have not been finalized as of the date of this report. Therefore the Build 2025 LOS results presented above reflect the existing and soon-to-be-outdated traffic signal timing parameters. It is expected that the NYSDOT's ongoing improvements will result in better operating levels as compared to those presented herein.**
- A signal warrant analysis of the NYS Route 211/NYS Route 416 intersection indicates that a signal is warranted in the No-Build condition based on Warrant 2. In the Build condition a signal is warranted based on Warrant 2 and Warrant 1 Condition A.
- A sight distance analysis demonstrates that intersection and stopping sight distances are adequate for the proposed site driveways on NYS Route 211 once vegetation is removed.

Please do not hesitate to call our office if you have any questions or comments, or require additional information.

Respectfully submitted,
Creighton Manning Engineering, LLP



Frank A. Filiciotto, PE
Associate



Starke W. Hipp, PE
Project Engineer

cc:

N:\Projects\2019\119-036 Engineering & Surveying Properties - KSH Development\Working\Report\20220513_TIS_119036.docx

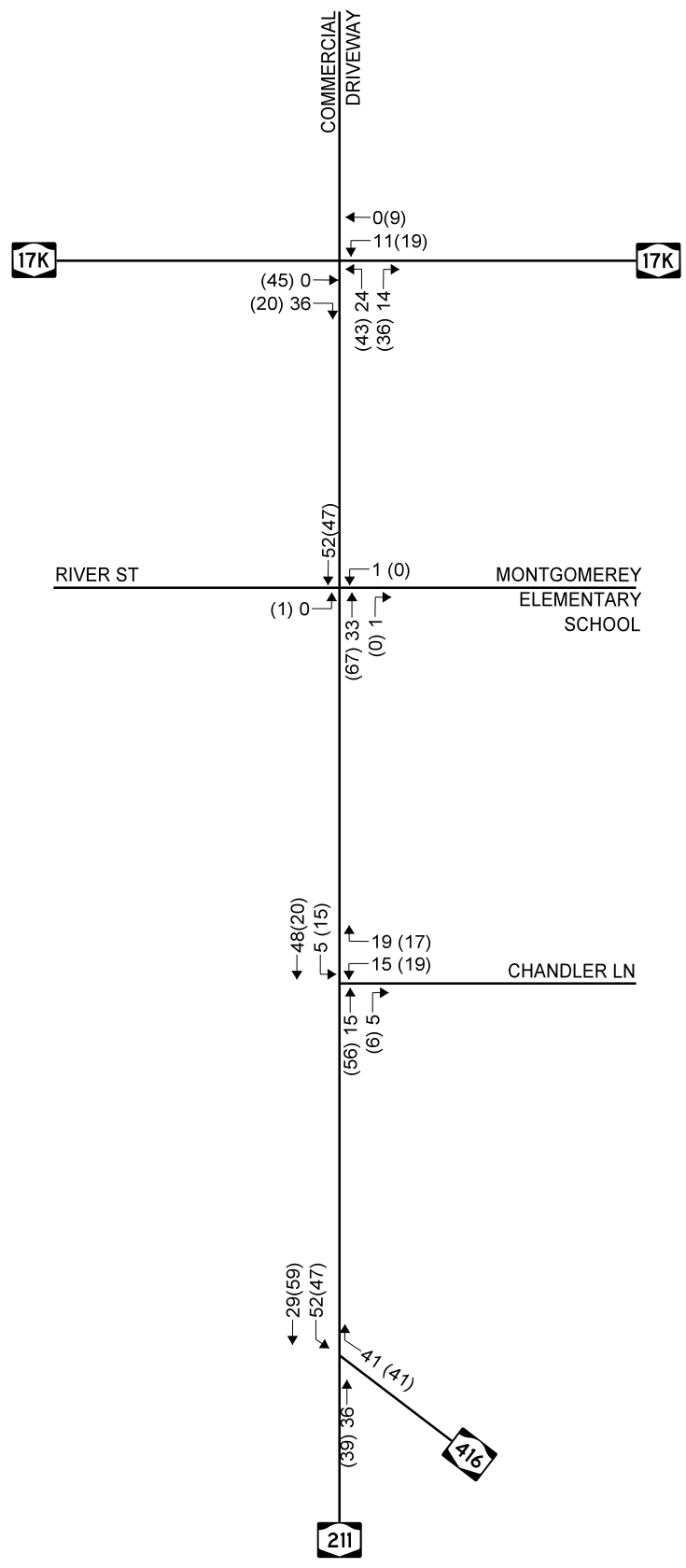
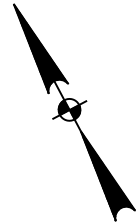

AM PEAK HOUR (PM PEAK HOUR)

OTHER DEVELOPMENTS
TRAFFIC VOLUMES

KSH DEVELOPMENT
VILLAGE OF MONTGOMERY,
ORANGE COUNTY, NEW YORK



N:\Projects\2019\119-036 Engineering & Surveying Properties - KSH Development\Working\CADD\ dgn\figures\119-036_fig_trcf_01.dgn

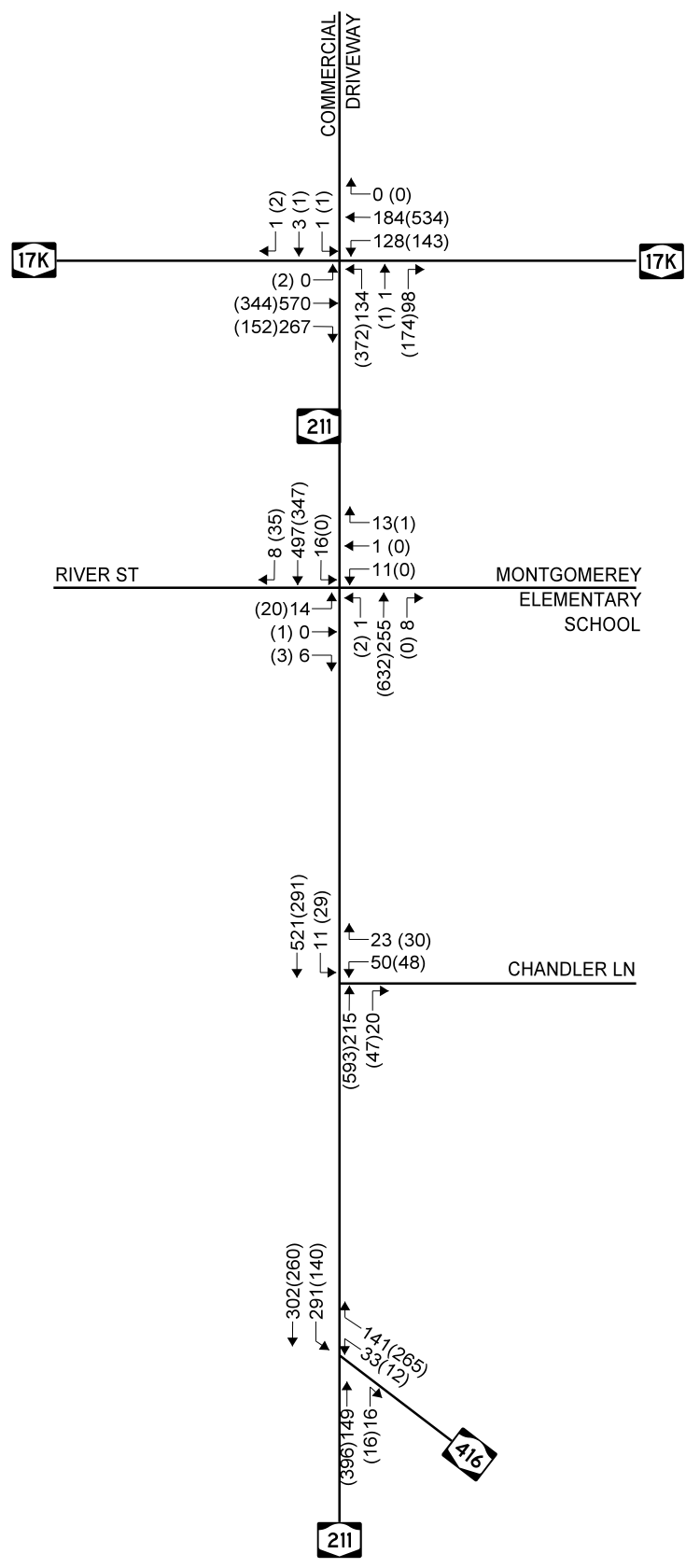
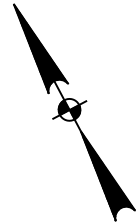

AM PEAK HOUR (PM PEAK HOUR)

2025 NO-BUILD TRAFFIC VOLUMES

KSH DEVELOPMENT
VILLAGE OF MONTGOMERY,
ORANGE COUNTY, NEW YORK



N:\Projects\2019\119-036 Engineering & Surveying Properties - KSH Development\Working\CADD\dgn\figures\119-036_fig_trcf_01.dgn

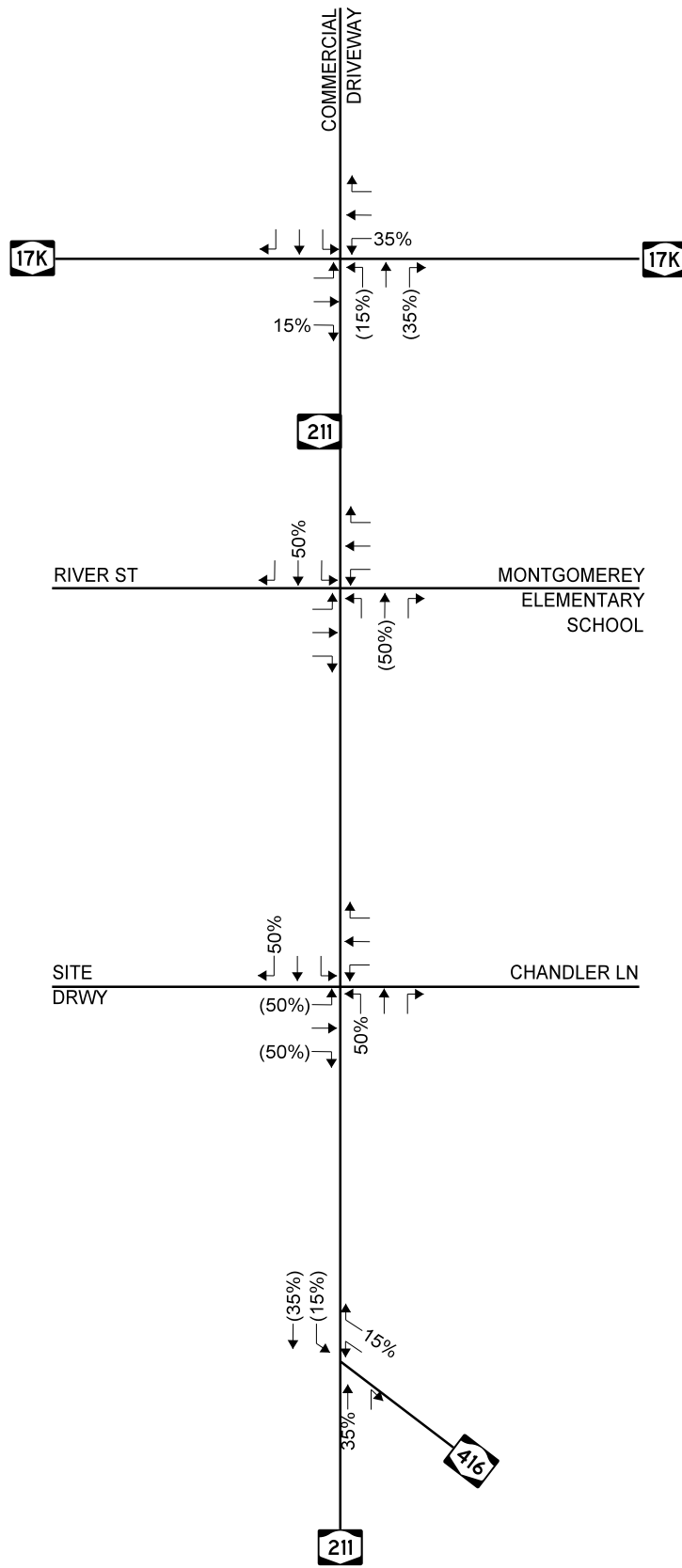

ENTER(EXIT)

WAREHOUSE PRIMARY
PASSENGER VEHICLE TRIP DISTRIBUTION

KSH DEVELOPMENT
VILLAGE OF MONTGOMERY,
ORANGE COUNTY, NEW YORK



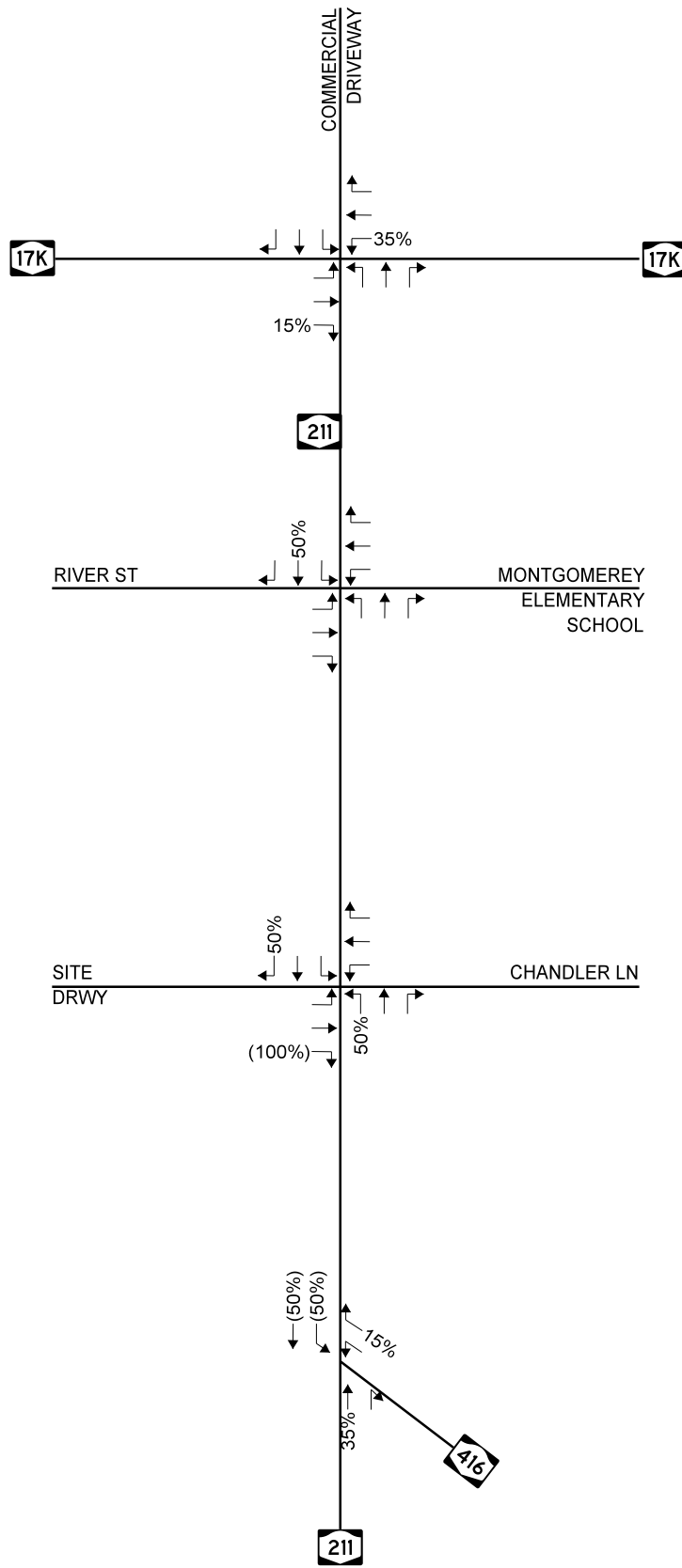

ENTER(EXIT)

WAREHOUSE PRIMARY
TRUCK TRIP DISTRIBUTION

KSH DEVELOPMENT
VILLAGE OF MONTGOMERY,
ORANGE COUNTY, NEW YORK



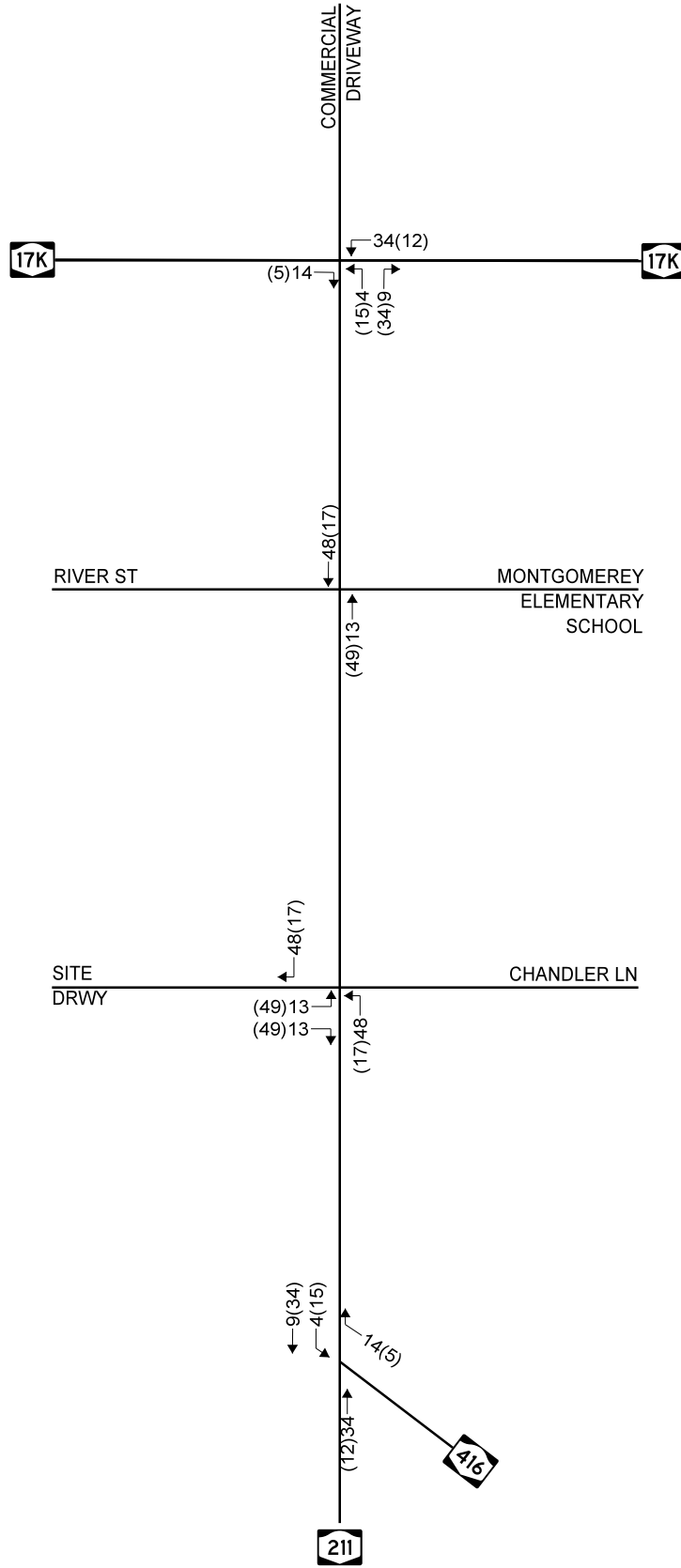
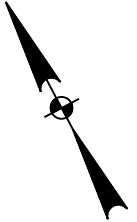

AM PEAK HOUR (PM PEAK HOUR)

WAREHOUSING PASSENGER VEHICLE
PRIMARY TRIP ASSIGNMENT

KSH DEVELOPMENT
VILLAGE OF MONTGOMERY,
ORANGE COUNTY, NEW YORK



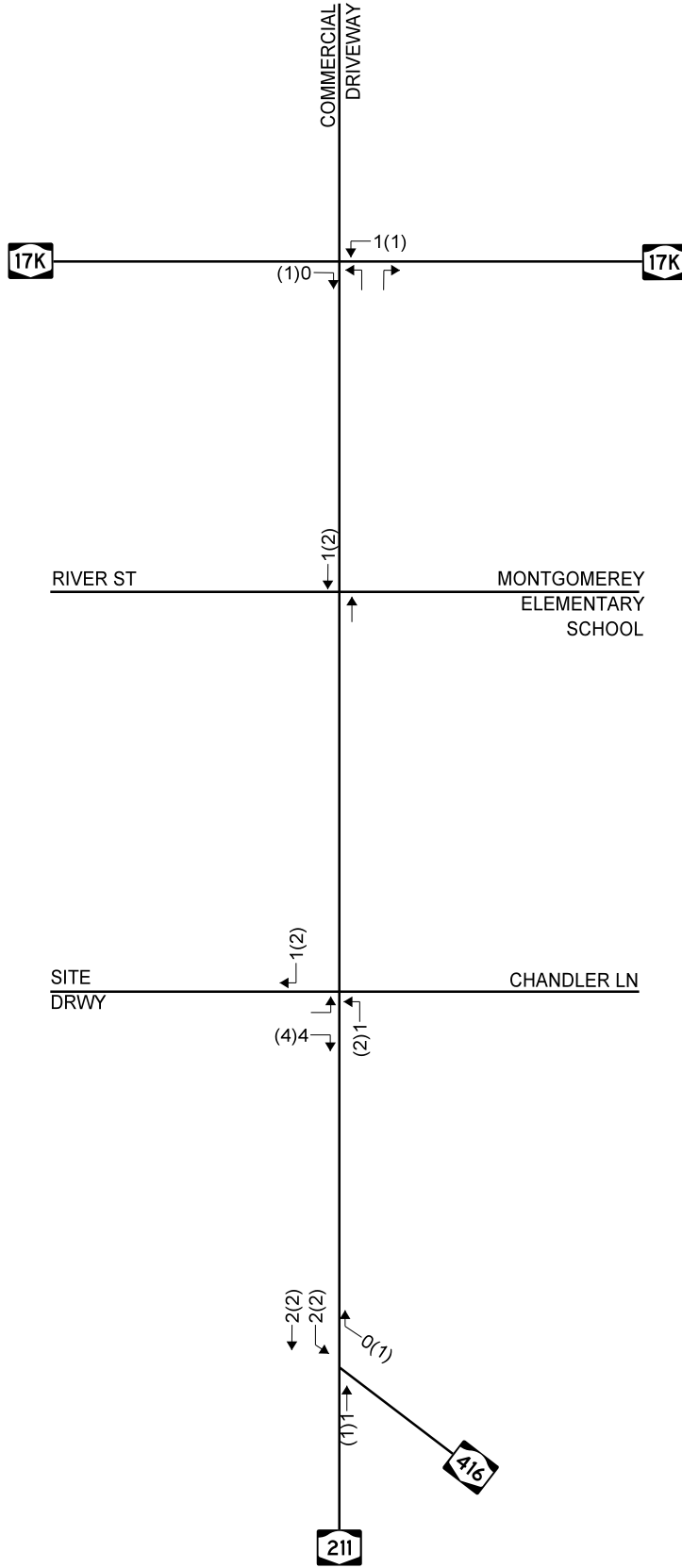

AM PEAK HOUR (PM PEAK HOUR)

WAREHOUSING TRUCK
PRIMARY ASSIGNMENT

KSH DEVELOPMENT
VILLAGE OF MONTGOMERY,
ORANGE COUNTY, NEW YORK



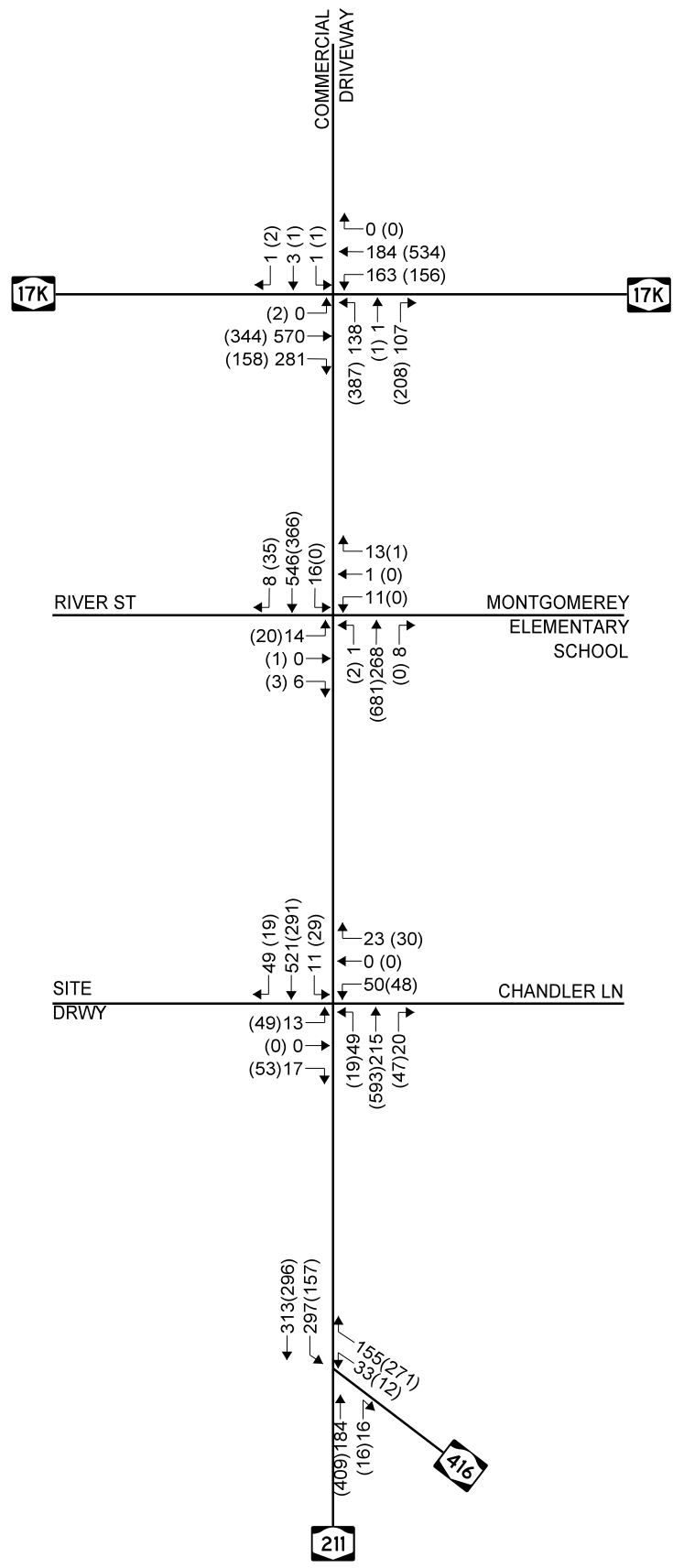
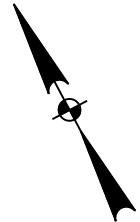

AM PEAK HOUR (PM PEAK HOUR)

2025 BUILD
TRAFFIC VOLUMES

KSH DEVELOPMENT
VILLAGE OF MONTGOMERY,
ORANGE COUNTY, NEW YORK



N:\Projects\2019\119-036 Engineering & Surveying Properties - KSH Development\Working\CADD\gn\figures\119-036_fig_trcf_01.dgn

Attachment A

Site Plan

**Traffic Impact Assessment
KSH Development
Village of Montgomery, New York**

Attachment B

TMC and ATR Data

**Traffic Impact Assessment
KSH Development
Village of Montgomery, New York**

Turning Movement Peak Hour Data (7:00 AM)

Start Time	Rte 17K Eastbound							Rte 17K Westbound							NY 211 Northbound							Southbound Approach Southbound							Int. Total	
	Left	Thru	Right	Right on Red	U-Turn	Peds	App. Total	Left	Thru	Right	Right on Red	U-Turn	Peds	App. Total	Left	Thru	Right	Right on Red	U-Turn	Peds	App. Total	Left	Thru	Right	Right on Red	U-Turn	Peds	App. Total		
7:00 AM	0	149	49	2	0	0	200	25	42	0	0	0	0	67	21	0	18	3	0	0	42	0	0	0	0	0	0	0	0	309
7:15 AM	0	138	56	1	0	0	195	29	48	0	0	0	0	77	27	1	14	2	0	0	44	0	0	0	0	0	0	0	0	316
7:30 AM	0	126	56	5	0	0	187	34	29	0	0	0	0	63	24	0	12	4	0	0	40	1	1	0	0	0	3	2	292	
7:45 AM	0	124	48	1	0	0	173	22	54	0	0	0	0	76	32	0	19	7	0	0	58	0	2	0	1	0	1	3	310	
Total	0	537	209	9	0	0	755	110	173	0	0	0	0	283	104	1	63	16	0	0	184	1	3	0	1	0	4	5	1227	
Approach %	0.0	71.1	27.7	1.2	0.0	-	-	38.9	61.1	0.0	0.0	0.0	-	-	56.5	0.5	34.2	8.7	0.0	-	-	20.0	60.0	0.0	20.0	0.0	-	-	-	
Total %	0.0	43.8	17.0	0.7	0.0	-	61.5	9.0	14.1	0.0	0.0	0.0	-	23.1	8.5	0.1	5.1	1.3	0.0	-	15.0	0.1	0.2	0.0	0.1	0.0	-	0.4	-	
PHF	0.000	0.901	0.933	0.450	0.000	-	0.944	0.809	0.801	0.000	0.000	0.000	-	0.919	0.813	0.250	0.829	0.571	0.000	-	0.793	0.250	0.375	0.000	0.250	0.000	-	0.417	0.971	
Lights	0	502	202	9	0	-	713	94	153	0	0	0	-	247	91	1	58	15	0	-	165	1	3	0	1	0	-	5	1130	
% Lights	-	93.5	96.7	100.0	-	-	94.4	85.5	88.4	-	-	-	-	87.3	87.5	100.0	92.1	93.8	-	-	89.7	100.0	100.0	-	100.0	-	-	-	100.0	
Buses	0	13	4	0	0	-	17	7	9	0	0	0	-	16	7	0	4	0	0	-	11	0	0	0	0	0	-	0	44	
% Buses	-	2.4	1.9	0.0	-	-	2.3	6.4	5.2	-	-	-	-	5.7	6.7	0.0	6.3	0.0	-	-	6.0	0.0	0.0	-	0.0	-	-	0.0	3.6	
Trucks	0	22	3	0	0	-	25	9	11	0	0	0	-	20	6	0	1	1	0	-	8	0	0	0	0	0	-	0	53	
% Trucks	-	4.1	1.4	0.0	-	-	3.3	8.2	6.4	-	-	-	-	7.1	5.8	0.0	1.6	6.3	-	-	4.3	0.0	0.0	-	0.0	-	-	0.0	4.3	
Bicycles on Crosswalk	-	-	-	-	-	0	-	-	-	-	-	-	0	-	-	-	-	-	-	0	-	-	-	-	-	-	0	-	-	
% Bicycles on Crosswalk	-	-	-	-	-	-	-	-	-	-	-	-	-	-	-	-	-	-	-	-	-	-	-	-	-	-	0.0	-	-	
Pedestrians	-	-	-	-	-	0	-	-	-	-	-	-	0	-	-	-	-	-	-	0	-	-	-	-	-	-	4	-	-	
% Pedestrians	-	-	-	-	-	-	-	-	-	-	-	-	-	-	-	-	-	-	-	-	-	-	-	-	-	-	100.0	-	-	

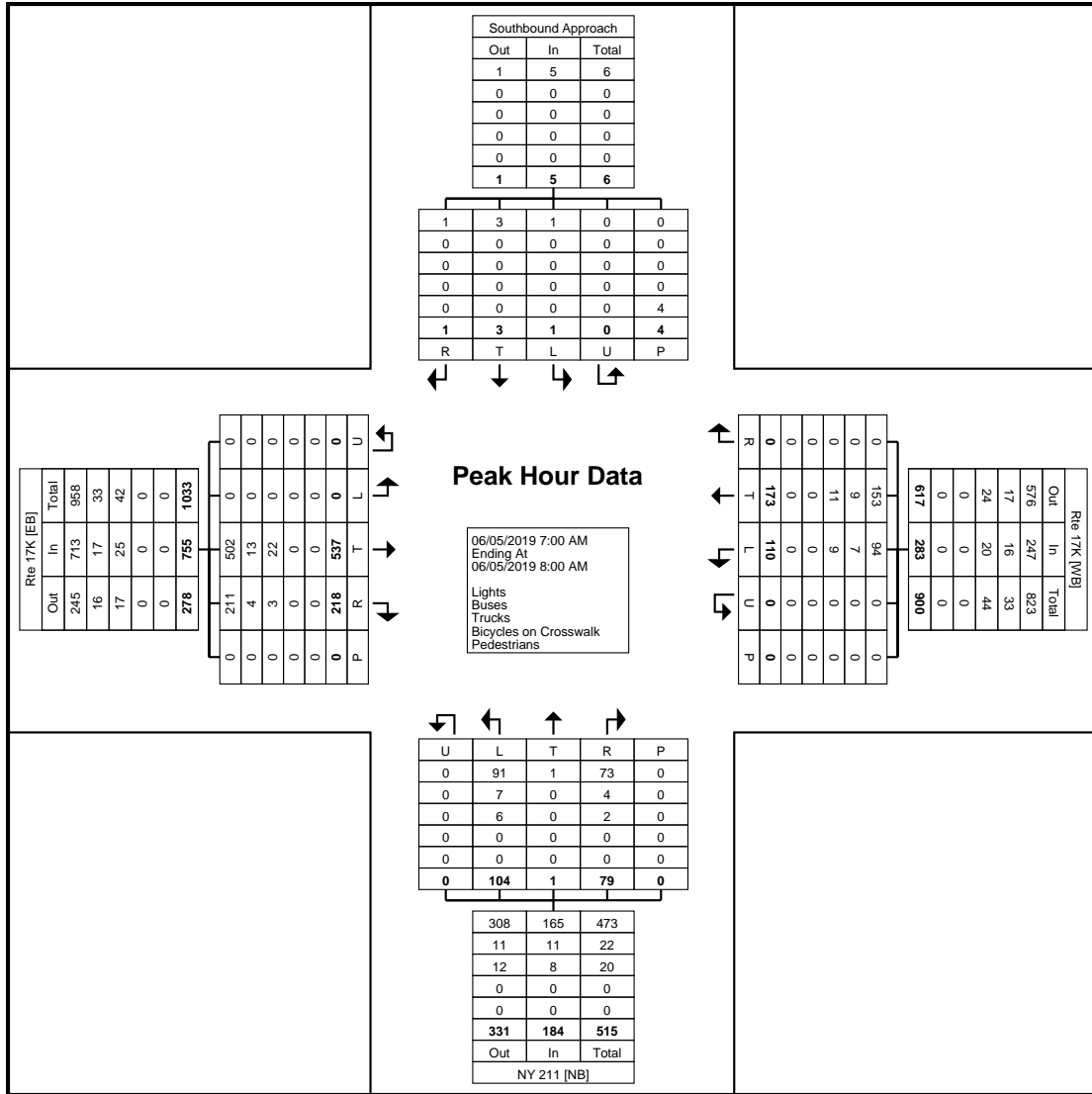

Turning Movement Peak Hour Data Plot (7:00 AM)

Turning Movement Peak Hour Data (4:45 PM)

Start Time	Rte 17K Eastbound							Rte 17K Westbound							NY 211 Northbound							Southbound Approach Southbound							Int. Total
	Left	Thru	Right	Right on Red	U-Turn	Peds	App. Total	Left	Thru	Right	Right on Red	U-Turn	Peds	App. Total	Left	Thru	Right	Right on Red	U-Turn	Peds	App. Total	Left	Thru	Right	Right on Red	U-Turn	Peds	App. Total	
4:45 PM	1	75	30	3	0	0	109	23	109	0	0	0	0	132	88	0	24	3	0	0	115	1	0	0	0	0	2	1	357
5:00 PM	1	67	33	1	0	0	102	30	111	0	0	0	1	141	74	1	30	2	0	0	107	0	1	1	1	0	4	3	353
5:15 PM	0	67	25	1	0	0	93	37	131	0	0	0	0	168	77	0	34	4	0	0	115	0	0	0	0	0	0	0	376
5:30 PM	0	73	29	2	0	0	104	27	144	0	0	0	0	171	71	0	25	8	0	0	104	0	0	0	0	0	1	0	379
Total	2	282	117	7	0	0	408	117	495	0	0	0	1	612	310	1	113	17	0	0	441	1	1	1	1	0	7	4	1465
Approach %	0.5	69.1	28.7	1.7	0.0	-	-	19.1	80.9	0.0	0.0	0.0	-	-	70.3	0.2	25.6	3.9	0.0	-	-	25.0	25.0	25.0	25.0	0.0	-	-	-
Total %	0.1	19.2	8.0	0.5	0.0	-	27.8	8.0	33.8	0.0	0.0	0.0	-	41.8	21.2	0.1	7.7	1.2	0.0	-	30.1	0.1	0.1	0.1	0.1	0.0	-	0.3	-
PHF	0.500	0.940	0.886	0.583	0.000	-	0.936	0.791	0.859	0.000	0.000	0.000	-	0.895	0.881	0.250	0.831	0.531	0.000	-	0.959	0.250	0.250	0.250	0.250	0.000	-	0.333	0.966
Lights	2	278	112	7	0	-	399	112	483	0	0	0	-	595	306	1	110	17	0	-	434	1	1	1	1	0	-	4	1432
% Lights	100.0	98.6	95.7	100.0	-	-	97.8	95.7	97.6	-	-	-	-	97.2	98.7	100.0	97.3	100.0	-	-	98.4	100.0	100.0	100.0	100.0	-	-	100.0	97.7
Buses	0	0	0	0	0	-	0	1	0	0	0	0	-	1	0	0	0	0	0	-	0	0	0	0	0	0	-	0	1
% Buses	0.0	0.0	0.0	0.0	-	-	0.0	0.9	0.0	-	-	-	-	0.2	0.0	0.0	0.0	0.0	-	-	0.0	0.0	0.0	0.0	0.0	-	-	0.0	0.1
Trucks	0	4	5	0	0	-	9	4	12	0	0	0	-	16	4	0	3	0	0	-	7	0	0	0	0	0	-	0	32
% Trucks	0.0	1.4	4.3	0.0	-	-	2.2	3.4	2.4	-	-	-	-	2.6	1.3	0.0	2.7	0.0	-	-	1.6	0.0	0.0	0.0	0.0	-	-	0.0	2.2
Bicycles on Crosswalk	-	-	-	-	-	0	-	-	-	-	-	-	0	-	-	-	-	-	-	0	-	-	-	-	-	-	0	-	-
% Bicycles on Crosswalk	-	-	-	-	-	-	-	-	-	-	-	-	0.0	-	-	-	-	-	-	-	-	-	-	-	-	-	0.0	-	-
Pedestrians	-	-	-	-	-	0	-	-	-	-	-	1	-	-	-	-	-	-	0	-	-	-	-	-	-	7	-	-	
% Pedestrians	-	-	-	-	-	-	-	-	-	-	-	100.0	-	-	-	-	-	-	-	-	-	-	-	-	-	100.0	-	-	

Turning Movement Peak Hour Data (7:30 AM)

Start Time	River St Eastbound						School Entrance Westbound						NY 211 Northbound						NY 211 Southbound						Int. Total
	Left	Thru	Right	U-Turn	Peds	App. Total	Left	Thru	Right	U-Turn	Peds	App. Total	Left	Thru	Right	U-Turn	Peds	App. Total	Left	Thru	Right	U-Turn	Peds	App. Total	
7:30 AM	1	0	1	0	1	2	0	0	1	0	0	1	0	45	0	0	0	45	1	125	1	0	0	127	175
7:45 AM	6	0	3	0	2	9	2	1	3	0	1	6	1	69	3	0	0	73	5	91	4	0	2	100	188
8:00 AM	2	0	1	0	0	3	3	0	3	0	4	6	0	45	2	0	0	47	4	86	2	0	0	92	148
8:15 AM	4	0	1	0	0	5	4	0	5	0	2	9	0	50	2	0	0	52	5	117	1	0	0	123	189
Total	13	0	6	0	3	19	9	1	12	0	7	22	1	209	7	0	0	217	15	419	8	0	2	442	700
Approach %	68.4	0.0	31.6	0.0	-	-	40.9	4.5	54.5	0.0	-	-	0.5	96.3	3.2	0.0	-	-	3.4	94.8	1.8	0.0	-	-	-
Total %	1.9	0.0	0.9	0.0	-	2.7	1.3	0.1	1.7	0.0	-	3.1	0.1	29.9	1.0	0.0	-	31.0	2.1	59.9	1.1	0.0	-	63.1	-
PHF	0.542	0.000	0.500	0.000	-	0.528	0.563	0.250	0.600	0.000	-	0.611	0.250	0.757	0.583	0.000	-	0.743	0.750	0.838	0.500	0.000	-	0.870	0.926
Lights	13	0	6	0	-	19	9	1	12	0	-	22	1	183	7	0	-	191	15	388	8	0	-	411	643
% Lights	100.0	-	100.0	-	-	100.0	100.0	100.0	100.0	-	-	100.0	100.0	87.6	100.0	-	-	88.0	100.0	92.6	100.0	-	-	93.0	91.9
Buses	0	0	0	0	-	0	0	0	0	0	-	0	0	13	0	0	-	13	0	13	0	0	-	13	26
% Buses	0.0	-	0.0	-	-	0.0	0.0	0.0	0.0	-	-	0.0	0.0	6.2	0.0	-	-	6.0	0.0	3.1	0.0	-	-	2.9	3.7
Trucks	0	0	0	0	-	0	0	0	0	0	-	0	0	13	0	0	-	13	0	18	0	0	-	18	31
% Trucks	0.0	-	0.0	-	-	0.0	0.0	0.0	0.0	-	-	0.0	0.0	6.2	0.0	-	-	6.0	0.0	4.3	0.0	-	-	4.1	4.4
Bicycles on Crosswalk	-	-	-	-	0	-	-	-	-	-	0	-	-	-	-	-	0	-	-	-	-	-	0	-	-
% Bicycles on Crosswalk	-	-	-	-	0.0	-	-	-	-	-	0.0	-	-	-	-	-	-	-	-	-	-	-	0.0	-	-
Pedestrians	-	-	-	-	3	-	-	-	-	-	7	-	-	-	-	-	0	-	-	-	-	-	2	-	-
% Pedestrians	-	-	-	-	100.0	-	-	-	-	-	100.0	-	-	-	-	-	-	-	-	-	-	-	100.0	-	-



www.TSTData.com
184 Baker Rd

Coatesville, Pennsylvania, United States 19320
610-466-1469
Serving Transportation Professionals Since 1995

Montgomery, NY
NY 211 & River St
Tuesday, June 5, 2019
Location: 41.520429, -
74.243441

Count Name: NY Rte 211 &
River St
Site Code: 3
Start Date: 06/05/2019
Page No: 5

Turning Movement Peak Hour Data (4:30 PM)

Start Time	River St Eastbound						School Entrance Westbound						NY 211 Northbound						NY 211 Southbound						Int. Total
	Left	Thru	Right	U-Turn	Peds	App. Total	Left	Thru	Right	U-Turn	Peds	App. Total	Left	Thru	Right	U-Turn	Peds	App. Total	Left	Thru	Right	U-Turn	Peds	App. Total	
4:30 PM	4	0	0	0	0	4	0	0	0	0	0	0	0	135	0	0	0	135	0	68	11	0	0	79	218
4:45 PM	5	0	1	0	1	6	0	0	0	0	0	0	0	121	0	0	0	121	0	66	7	0	0	73	200
5:00 PM	6	0	1	0	3	7	0	0	0	0	0	0	1	119	0	0	0	120	0	81	8	0	0	89	216
5:15 PM	3	1	1	0	2	5	0	0	1	0	3	1	1	157	0	0	0	158	0	68	7	0	2	75	239
Total	18	1	3	0	6	22	0	0	1	0	3	1	2	532	0	0	0	534	0	283	33	0	2	316	873
Approach %	81.8	4.5	13.6	0.0	-	-	0.0	0.0	100.0	0.0	-	-	0.4	99.6	0.0	0.0	-	-	0.0	89.6	10.4	0.0	-	-	-
Total %	2.1	0.1	0.3	0.0	-	2.5	0.0	0.0	0.1	0.0	-	0.1	0.2	60.9	0.0	0.0	-	61.2	0.0	32.4	3.8	0.0	-	36.2	-
PHF	0.750	0.250	0.750	0.000	-	0.786	0.000	0.000	0.250	0.000	-	0.250	0.500	0.847	0.000	0.000	-	0.845	0.000	0.873	0.750	0.000	-	0.888	0.913
Lights	18	1	3	0	-	22	0	0	1	0	-	1	2	523	0	0	-	525	0	272	33	0	-	305	853
% Lights	100.0	100.0	100.0	-	-	100.0	-	-	100.0	-	-	100.0	100.0	98.3	-	-	-	98.3	-	96.1	100.0	-	-	96.5	97.7
Buses	0	0	0	0	-	0	0	0	0	0	-	0	0	1	0	0	-	1	0	0	0	0	-	0	1
% Buses	0.0	0.0	0.0	-	-	0.0	-	-	0.0	-	-	0.0	0.0	0.2	-	-	-	0.2	-	0.0	0.0	-	-	0.0	0.1
Trucks	0	0	0	0	-	0	0	0	0	0	-	0	0	8	0	0	-	8	0	11	0	0	-	11	19
% Trucks	0.0	0.0	0.0	-	-	0.0	-	-	0.0	-	-	0.0	0.0	1.5	-	-	-	1.5	-	3.9	0.0	-	-	3.5	2.2
Bicycles on Crosswalk	-	-	-	-	2	-	-	-	-	-	0	-	-	-	-	-	0	-	-	-	-	-	1	-	-
% Bicycles on Crosswalk	-	-	-	-	33.3	-	-	-	-	-	0.0	-	-	-	-	-	-	-	-	-	-	-	50.0	-	-
Pedestrians	-	-	-	-	4	-	-	-	-	-	3	-	-	-	-	-	0	-	-	-	-	-	1	-	-
% Pedestrians	-	-	-	-	66.7	-	-	-	-	-	100.0	-	-	-	-	-	-	-	-	-	-	-	50.0	-	-

Montgomery, NY
NY 211 & Chandler Lane
Wednesday, June 5, 2019
Location: 41.51497, -74.24947

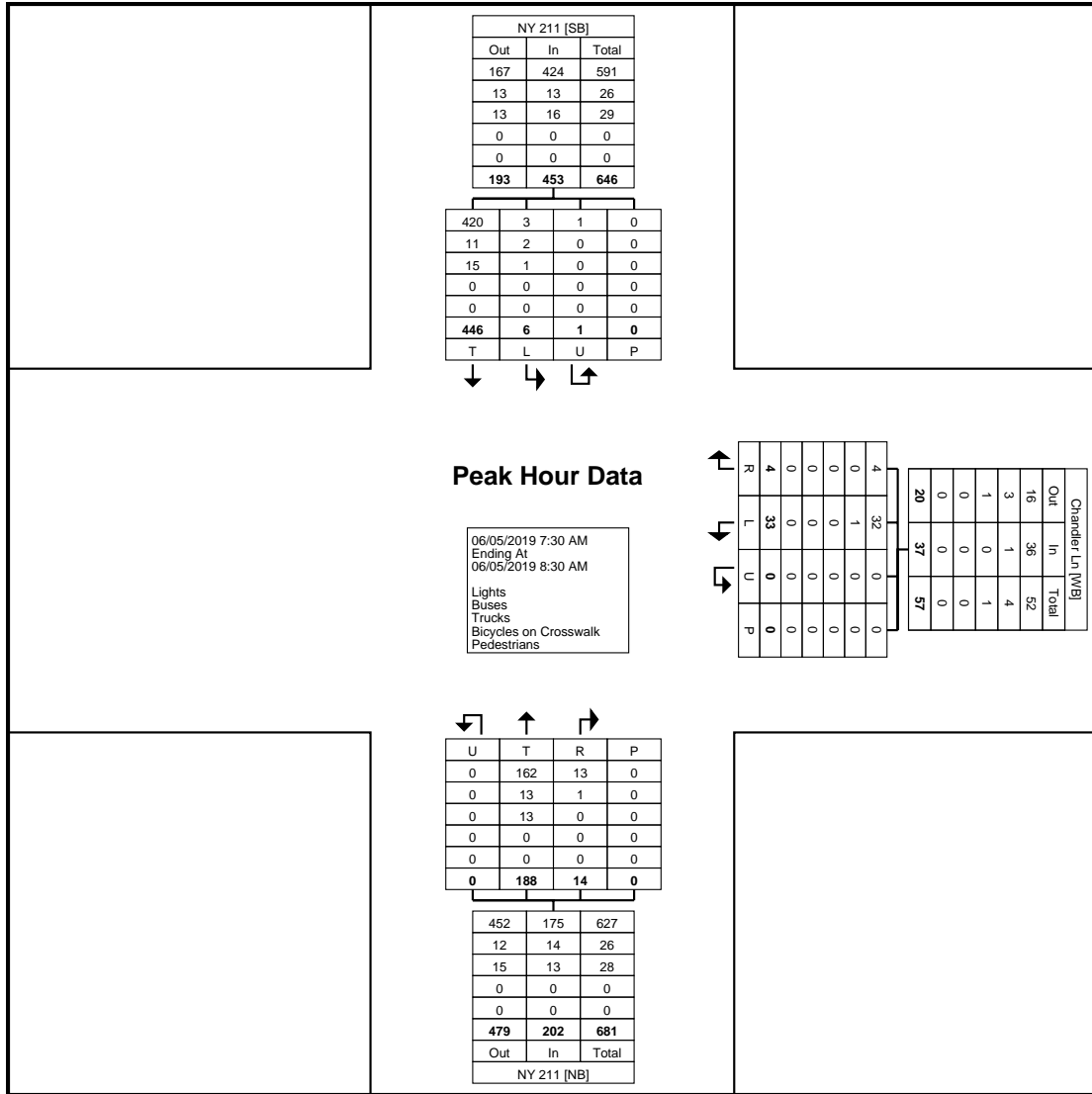

Turning Movement Peak Hour Data Plot (7:30 AM)

Montgomery, NY
NY 211 & Chandler Lane
Wednesday, June 5, 2019
Location: 41.51497, -74.24947

Turning Movement Peak Hour Data (4:30 PM)

Start Time	Chandler Ln Westbound					NY 211 Northbound					NY 211 Southbound					Int. Total
	Left	Right	U-Turn	Peds	App. Total	Thru	Right	U-Turn	Peds	App. Total	Left	Thru	U-Turn	Peds	App. Total	
4:30 PM	8	1	0	0	9	122	9	0	0	131	2	62	0	1	64	204
4:45 PM	9	4	0	0	13	122	11	0	0	133	4	63	0	0	67	213
5:00 PM	2	2	0	0	4	119	8	0	0	127	2	68	0	0	70	201
5:15 PM	8	5	0	0	13	143	11	0	0	154	5	57	0	0	62	229
Total	27	12	0	0	39	506	39	0	0	545	13	250	0	1	263	847
Approach %	69.2	30.8	0.0	-	-	92.8	7.2	0.0	-	-	4.9	95.1	0.0	-	-	-
Total %	3.2	1.4	0.0	-	4.6	59.7	4.6	0.0	-	64.3	1.5	29.5	0.0	-	31.1	-
PHF	0.750	0.600	0.000	-	0.750	0.885	0.886	0.000	-	0.885	0.650	0.919	0.000	-	0.939	0.925
Lights	26	12	0	-	38	498	39	0	-	537	12	239	0	-	251	826
% Lights	96.3	100.0	-	-	97.4	98.4	100.0	-	-	98.5	92.3	95.6	-	-	95.4	97.5
Buses	0	0	0	-	0	0	0	0	-	0	0	0	0	-	0	0
% Buses	0.0	0.0	-	-	0.0	0.0	0.0	-	-	0.0	0.0	0.0	-	-	0.0	0.0
Trucks	1	0	0	-	1	8	0	0	-	8	1	11	0	-	12	21
% Trucks	3.7	0.0	-	-	2.6	1.6	0.0	-	-	1.5	7.7	4.4	-	-	4.6	2.5
Bicycles on Crosswalk	-	-	-	0	-	-	-	-	0	-	-	-	-	0	-	-
% Bicycles on Crosswalk	-	-	-	-	-	-	-	-	-	-	-	-	-	0.0	-	-
Pedestrians	-	-	-	0	-	-	-	-	0	-	-	-	-	1	-	-
% Pedestrians	-	-	-	-	-	-	-	-	-	-	-	-	-	100.0	-	-

Montgomery, NY
NY 211 & Chandler Lane
Wednesday, June 5, 2019
Location: 41.51497, -74.24947

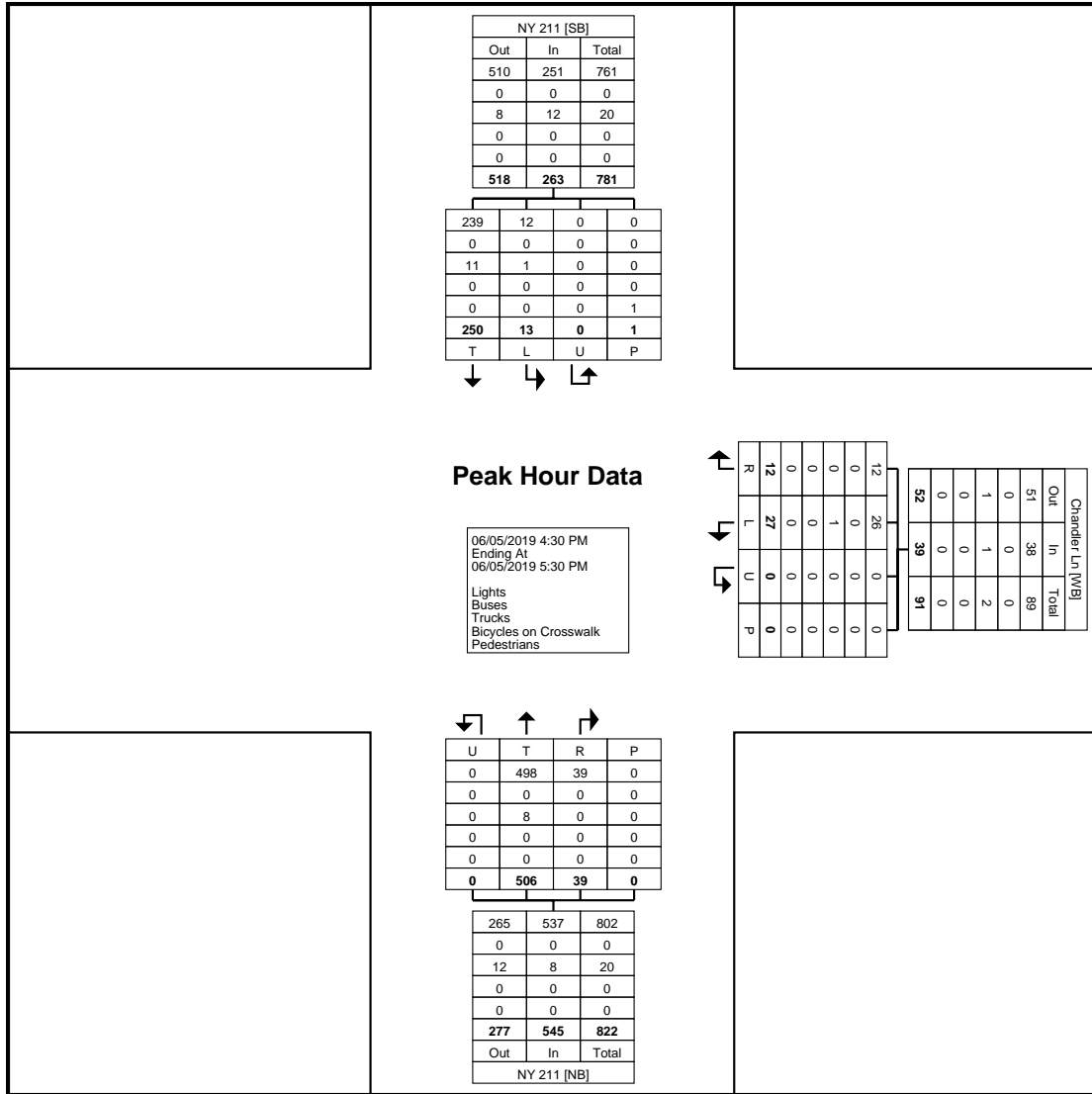

Turning Movement Peak Hour Data Plot (4:30 PM)

Montgomery, NY
NY 211 & NY 416
Wednesday, June 5, 2019
Location: 41.51178, -74.25252

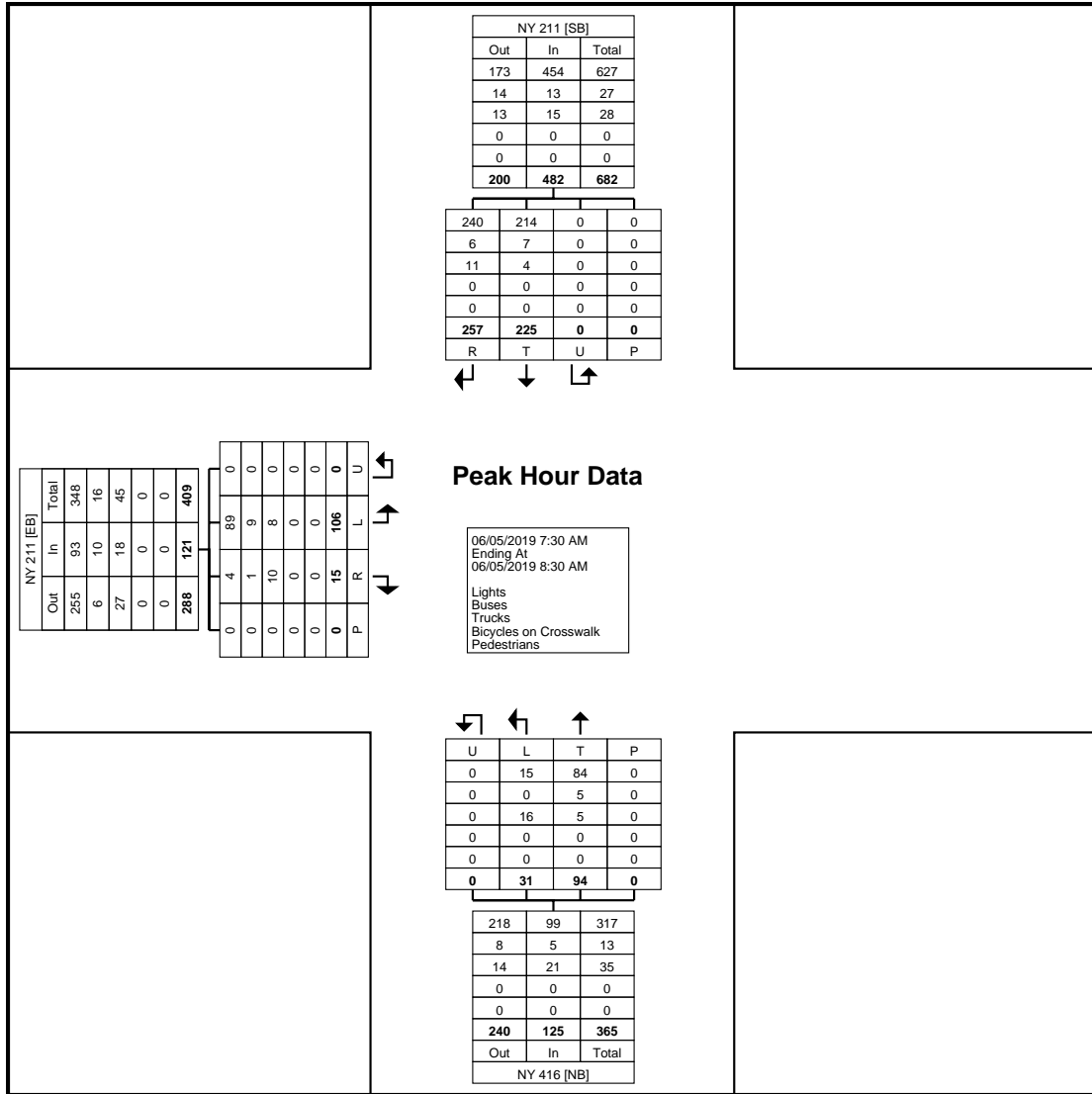

Turning Movement Peak Hour Data Plot (7:30 AM)

Montgomery, NY
NY 211 & NY 416
Wednesday, June 5, 2019
Location: 41.51178, -74.25252

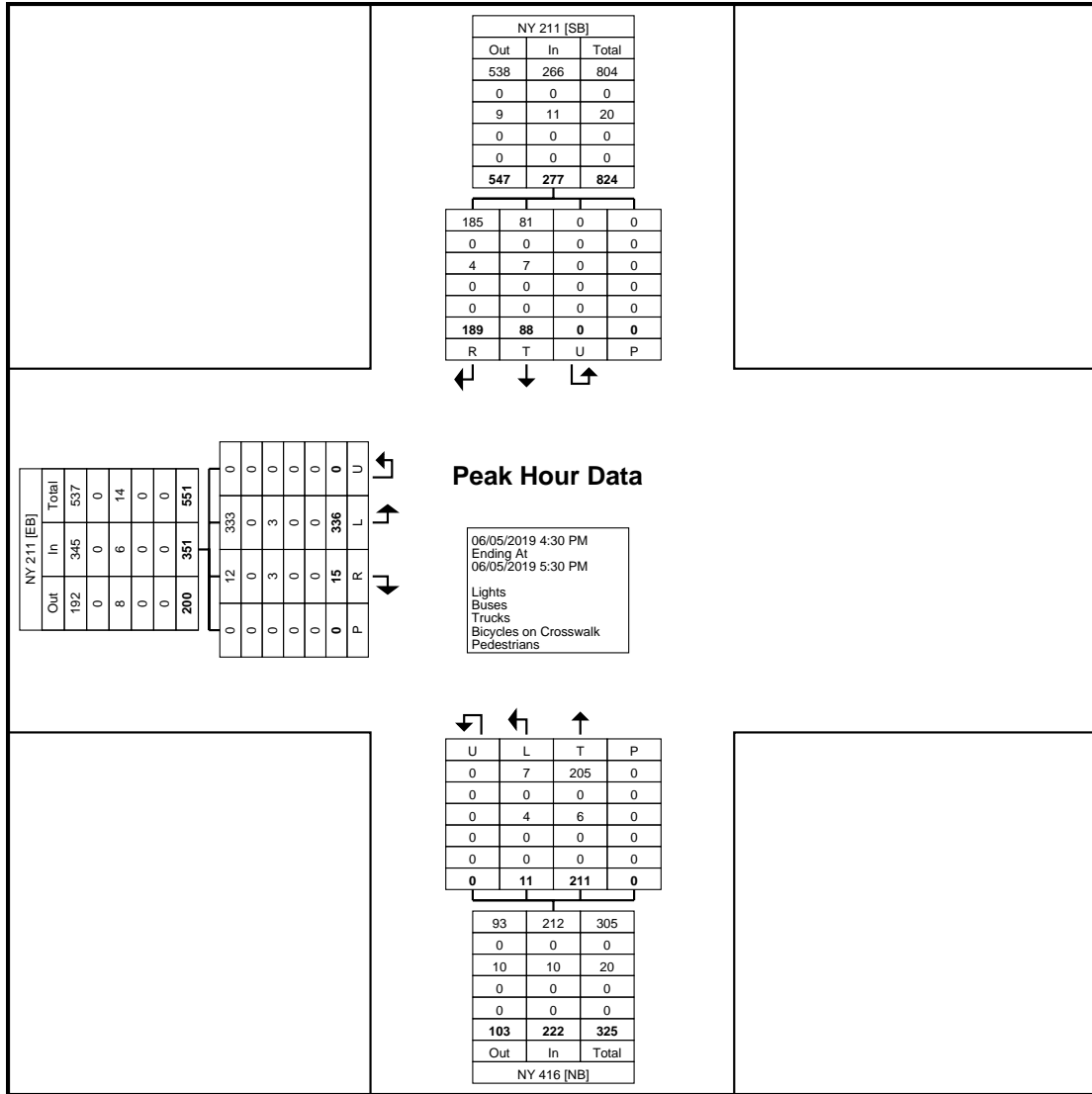

Turning Movement Peak Hour Data Plot (4:30 PM)

Tri-State Traffic Data, Inc.

TSTData.com
(610) 466-1460

Rd Name: Chandler Ln
 Section: 160' E OF RTE 211
 Counter ID: AP300DKS

Site Code: Chandler Ln
 Station ID: 00000000000
 41.514692, -74.248965

Latitude: 0' 0.0000 Undefined

Start Time	03-Jun-19		04-Jun-19		05-Jun-19		06-Jun-19		07-Jun-19		Weekday Average		08-Jun-19		09-Jun-19	
	Direction 1 East	Direction 2 West	Direction 1 East	Direction 2 West	Direction 1 East	Direction 2 West	Direction 1 East	Direction 2 West	Direction 1 East	Direction 2 West	Direction 1 East	Direction 2 West	Direction 1 East	Direction 2 West	Direction 1 East	Direction 2 West
12:00 AM	*	*	*	*	1	1	6	0	4	0	4	0	6	3	10	3
01:00	*	*	*	*	6	1	1	1	6	1	4	1	4	3	6	2
02:00	*	*	*	*	2	3	1	2	1	1	1	2	1	3	1	0
03:00	*	*	*	*	1	1	1	0	2	1	1	1	0	0	1	1
04:00	*	*	*	*	1	5	2	5	0	3	1	4	0	1	1	1
05:00	*	*	*	*	1	10	3	9	2	11	2	10	4	1	6	3
06:00	*	*	*	*	7	26	4	29	8	22	6	26	2	1	0	5
07:00	*	*	*	*	15	49	19	46	22	32	19	42	4	22	5	6
08:00	*	*	*	*	17	40	16	43	18	46	17	43	19	31	9	27
09:00	*	*	*	*	20	33	24	36	21	43	22	37	22	33	20	24
10:00	*	*	*	*	31	24	31	28	30	34	31	29	36	45	19	36
11:00	*	*	*	*	27	50	33	36	37	35	32	40	34	45	24	30
12:00 PM	*	*	*	*	50	38	32	32	44	30	42	33	50	38	39	32
01:00	*	*	*	*	38	26	31	34	34	42	34	34	39	41	39	31
02:00	*	*	*	*	53	38	43	42	34	46	43	42	43	32	42	28
03:00	*	*	*	*	62	39	64	39	67	37	64	38	67	33	38	29
04:00	*	*	*	*	57	42	45	46	50	49	51	46	38	43	44	27
05:00	*	*	*	*	49	30	62	40	49	38	53	36	30	36	37	32
06:00	*	*	*	*	31	29	39	31	42	36	37	32	33	23	22	24
07:00	*	*	*	*	29	22	19	27	29	31	26	27	21	19	30	31
08:00	*	*	*	*	27	16	28	13	33	24	30	18	18	13	23	17
09:00	*	*	*	*	13	9	13	12	20	11	16	10	20	7	13	10
10:00	*	*	*	*	16	11	11	4	16	10	14	7	11	12	6	8
11:00	*	*	*	*	8	2	10	2	10	2	9	2	13	5	5	4
Total Day	0	0	71	108	562	545	538	557	579	585	559	560	483	488	440	411
AM Peak Vol.	-	-	-	-	10:00	11:00	11:00	07:00	11:00	08:00	11:00	08:00	10:00	10:00	11:00	10:00
PM Peak Vol.	-	-	20:00	20	15:00	16:00	15:00	16:00	15:00	16:00	15:00	16:00	12:00	16:00	16:00	12:00

Tri-State Traffic Data, Inc.

TSTData.com
(610) 466-1460

Rd Name: Chandler Ln
 Section: 160' E OF RTE 211
 Counter ID: AP300DKS

Site Code: Chandler Ln
 Station ID: 00000000000
 41.514692, -74.248965

Latitude: 0' 0.0000 Undefined

Start Time	10-Jun-19		11-Jun-19		12-Jun-19		13-Jun-19		14-Jun-19		15-Jun-19		16-Jun-19		Weekday Average	
	Direction 1 East	Direction 2 West	Direction 1 East	Direction 2 West	Direction 1 East	Direction 2 West	Direction 1 East	Direction 2 West	Direction 1 East	Direction 2 West	Direction 1 East	Direction 2 West	Direction 1 East	Direction 2 West		
12:00 AM	2	0	*	*	*	*	*	*	*	*	*	*	*	*	2	0
01:00	2	0	*	*	*	*	*	*	*	*	*	*	*	*	2	0
02:00	3	1	*	*	*	*	*	*	*	*	*	*	*	*	3	1
03:00	2	3	*	*	*	*	*	*	*	*	*	*	*	*	2	3
04:00	1	7	*	*	*	*	*	*	*	*	*	*	*	*	1	7
05:00	1	10	*	*	*	*	*	*	*	*	*	*	*	*	1	10
06:00	14	23	*	*	*	*	*	*	*	*	*	*	*	*	14	23
07:00	*	*	*	*	*	*	*	*	*	*	*	*	*	*	*	*
08:00	*	*	*	*	*	*	*	*	*	*	*	*	*	*	*	*
09:00	*	*	*	*	*	*	*	*	*	*	*	*	*	*	*	*
10:00	*	*	*	*	*	*	*	*	*	*	*	*	*	*	*	*
11:00	*	*	*	*	*	*	*	*	*	*	*	*	*	*	*	*
12:00 PM	*	*	*	*	*	*	*	*	*	*	*	*	*	*	*	*
01:00	*	*	*	*	*	*	*	*	*	*	*	*	*	*	*	*
02:00	*	*	*	*	*	*	*	*	*	*	*	*	*	*	*	*
03:00	*	*	*	*	*	*	*	*	*	*	*	*	*	*	*	*
04:00	*	*	*	*	*	*	*	*	*	*	*	*	*	*	*	*
05:00	*	*	*	*	*	*	*	*	*	*	*	*	*	*	*	*
06:00	*	*	*	*	*	*	*	*	*	*	*	*	*	*	*	*
07:00	*	*	*	*	*	*	*	*	*	*	*	*	*	*	*	*
08:00	*	*	*	*	*	*	*	*	*	*	*	*	*	*	*	*
09:00	*	*	*	*	*	*	*	*	*	*	*	*	*	*	*	*
10:00	*	*	*	*	*	*	*	*	*	*	*	*	*	*	*	*
11:00	*	*	*	*	*	*	*	*	*	*	*	*	*	*	*	*
Total	25	44	0	0	0	0	0	0	0	0	0	0	0	0	25	44
Day	69	0	0	0	0	0	0	0	0	0	0	0	0	0	69	0
AM Peak	06:00	06:00	-	-	-	-	-	-	-	-	-	-	-	-	06:00	06:00
Vol.	14	23	-	-	-	-	-	-	-	-	-	-	-	-	14	23
PM Peak	-	-	-	-	-	-	-	-	-	-	-	-	-	-	-	-
Vol.	-	-	-	-	-	-	-	-	-	-	-	-	-	-	-	-
Comb. Total	69	108	1107	1095	1164	1188	971	851								
ADT	ADT 1,039	ADT 1,039	AADT 1,039													

Tri-State Traffic Data, Inc
 184 Baker Rd
 Coatesville, PA 19320

Site Code: Chandler Ln
 Station ID: 000000000000
 41.514692, -74.248965

Latitude: 0' 0.0000 Undefined

Direction 1 East

Start Time	0	6	11	16	21	26	31	36	41	46	51	56	61	66	71	Total
Time	5	10	15	20	25	30	35	40	45	50	55	60	65	70	75	
06/10/1																
9	0	0	0	1	1	0	0	0	0	0	0	0	0	0	0	2
01:00	0	0	0	0	1	1	0	0	0	0	0	0	0	0	0	2
02:00	0	0	0	0	2	1	0	0	0	0	0	0	0	0	0	3
03:00	0	0	0	0	1	0	1	0	0	0	0	0	0	0	0	2
04:00	0	0	0	0	1	0	0	0	0	0	0	0	0	0	0	1
05:00	0	0	0	0	1	0	0	0	0	0	0	0	0	0	0	1
06:00	0	0	0	3	6	5	0	0	0	0	0	0	0	0	0	14
07:00	*	*	*	*	*	*	*	*	*	*	*	*	*	*	*	*
08:00	*	*	*	*	*	*	*	*	*	*	*	*	*	*	*	*
09:00	*	*	*	*	*	*	*	*	*	*	*	*	*	*	*	*
10:00	*	*	*	*	*	*	*	*	*	*	*	*	*	*	*	*
11:00	*	*	*	*	*	*	*	*	*	*	*	*	*	*	*	*
12 PM	*	*	*	*	*	*	*	*	*	*	*	*	*	*	*	*
13:00	*	*	*	*	*	*	*	*	*	*	*	*	*	*	*	*
14:00	*	*	*	*	*	*	*	*	*	*	*	*	*	*	*	*
15:00	*	*	*	*	*	*	*	*	*	*	*	*	*	*	*	*
16:00	*	*	*	*	*	*	*	*	*	*	*	*	*	*	*	*
17:00	*	*	*	*	*	*	*	*	*	*	*	*	*	*	*	*
18:00	*	*	*	*	*	*	*	*	*	*	*	*	*	*	*	*
19:00	*	*	*	*	*	*	*	*	*	*	*	*	*	*	*	*
20:00	*	*	*	*	*	*	*	*	*	*	*	*	*	*	*	*
21:00	*	*	*	*	*	*	*	*	*	*	*	*	*	*	*	*
22:00	*	*	*	*	*	*	*	*	*	*	*	*	*	*	*	*
23:00	*	*	*	*	*	*	*	*	*	*	*	*	*	*	*	*
Total	0	0	0	4	13	7	1	0	0	0	0	0	0	0	0	25
Grand Total	0	18	34	397	1333	824	87	5	0	0	0	0	0	0	0	2698

Stats	15th Percentile :	19 MPH
	50th Percentile :	23 MPH
	85th Percentile :	28 MPH
	95th Percentile :	29 MPH
	Mean Speed(Average) :	24 MPH
	10 MPH Pace Speed :	21-30 MPH
	Number in Pace :	2157
	Percent in Pace :	79.9%
	Number of Vehicles > 55 MPH :	0
	Percent of Vehicles > 55 MPH :	0.0%

Tri-State Traffic Data, Inc
 184 Baker Rd
 Coatesville, PA 19320

Site Code: Chandler Ln
 Station ID: 000000000000
 41.514692, -74.248965

Latitude: 0' 0.0000 Undefined

Direction 2 West

Start Time	0	6	11	16	21	26	31	36	41	46	51	56	61	66	71	Total
Time	5	10	15	20	25	30	35	40	45	50	55	60	65	70	75	
06/10/1																
9	0	0	0	0	0	0	0	0	0	0	0	0	0	0	0	0
01:00	0	0	0	0	0	0	0	0	0	0	0	0	0	0	0	0
02:00	0	0	0	0	1	0	0	0	0	0	0	0	0	0	0	1
03:00	0	0	0	2	0	1	0	0	0	0	0	0	0	0	0	3
04:00	0	0	0	0	3	2	2	0	0	0	0	0	0	0	0	7
05:00	0	0	0	3	5	2	0	0	0	0	0	0	0	0	0	10
06:00	0	0	1	1	9	9	3	0	0	0	0	0	0	0	0	23
07:00	*	*	*	*	*	*	*	*	*	*	*	*	*	*	*	*
08:00	*	*	*	*	*	*	*	*	*	*	*	*	*	*	*	*
09:00	*	*	*	*	*	*	*	*	*	*	*	*	*	*	*	*
10:00	*	*	*	*	*	*	*	*	*	*	*	*	*	*	*	*
11:00	*	*	*	*	*	*	*	*	*	*	*	*	*	*	*	*
12 PM	*	*	*	*	*	*	*	*	*	*	*	*	*	*	*	*
13:00	*	*	*	*	*	*	*	*	*	*	*	*	*	*	*	*
14:00	*	*	*	*	*	*	*	*	*	*	*	*	*	*	*	*
15:00	*	*	*	*	*	*	*	*	*	*	*	*	*	*	*	*
16:00	*	*	*	*	*	*	*	*	*	*	*	*	*	*	*	*
17:00	*	*	*	*	*	*	*	*	*	*	*	*	*	*	*	*
18:00	*	*	*	*	*	*	*	*	*	*	*	*	*	*	*	*
19:00	*	*	*	*	*	*	*	*	*	*	*	*	*	*	*	*
20:00	*	*	*	*	*	*	*	*	*	*	*	*	*	*	*	*
21:00	*	*	*	*	*	*	*	*	*	*	*	*	*	*	*	*
22:00	*	*	*	*	*	*	*	*	*	*	*	*	*	*	*	*
23:00	*	*	*	*	*	*	*	*	*	*	*	*	*	*	*	*
Total	0	0	1	6	18	14	5	0	0	0	0	0	0	0	0	44
Grand Total	0	5	36	307	1136	1004	170	9	0	0	0	0	0	0	0	2667

Stats

15th Percentile : 20 MPH
 50th Percentile : 24 MPH
 85th Percentile : 28 MPH
 95th Percentile : 31 MPH

Mean Speed(Average) : 25 MPH
 10 MPH Pace Speed : 21-30 MPH
 Number in Pace : 2140
 Percent in Pace : 80.2%
 Number of Vehicles > 55 MPH : 0
 Percent of Vehicles > 55 MPH : 0.0%

Tri-State Traffic Data, Inc
 184 Baker Rd
 Coatesville, PA 19320

Site Code: Chandler Ln
 Station ID: 000000000000
 41.514692, -74.248965

Latitude: 0' 0.0000 Undefined

Direction 1 East

Start Time	Class 1	Class 2	Class 3	Class 4	Class 5	Class 6	Class 7	Class 8	Class 9	Class 10	Class 11	Class 12	Class 13	Class 14	Class 15	Total
12 PM	0	7	0	0	0	0	0	0	0	0	0	0	0	0	0	7
12:15	0	12	1	2	0	0	0	0	0	0	0	0	0	0	0	15
12:30	0	14	3	1	1	0	0	0	0	0	0	0	0	0	0	19
12:45	0	8	0	1	0	0	0	0	0	0	0	0	0	0	0	9
	0	41	4	4	1	0	0	0	0	0	0	0	0	0	0	50
13:00	1	4	3	0	2	0	0	0	0	0	0	0	0	0	0	10
13:15	0	11	0	0	0	0	0	0	0	0	0	0	0	1	0	12
13:30	0	7	1	0	0	0	0	0	0	0	0	0	0	0	0	8
13:45	0	6	2	0	0	0	0	0	0	0	0	0	0	0	0	8
	1	28	6	0	2	0	0	0	0	0	0	0	0	1	0	38
14:00	0	8	0	0	0	0	0	0	0	0	0	0	0	0	0	8
14:15	0	9	1	0	2	0	0	0	0	0	0	0	0	0	0	12
14:30	0	10	3	0	0	0	0	0	0	0	0	0	0	0	0	13
14:45	1	15	2	1	0	1	0	0	0	0	0	0	0	0	0	20
	1	42	6	1	2	1	0	0	0	0	0	0	0	0	0	53
15:00	0	12	3	0	1	0	0	0	0	0	0	0	0	0	0	16
15:15	0	9	2	0	0	0	0	0	0	0	0	0	0	0	0	11
15:30	0	13	4	0	0	0	0	1	0	0	0	0	0	0	0	18
15:45	0	14	1	0	1	0	0	1	0	0	0	0	0	0	0	17
	0	48	10	0	2	0	0	2	0	0	0	0	0	0	0	62
16:00	0	14	4	0	0	0	0	0	0	0	0	0	0	0	0	18
16:15	1	7	5	0	0	0	0	0	0	0	0	0	0	0	0	13
16:30	0	12	0	0	0	0	0	0	0	0	0	0	0	0	0	12
16:45	0	13	1	0	0	0	0	0	0	0	0	0	0	0	0	14
	1	46	10	0	0	0	0	0	0	0	0	0	0	0	0	57
17:00	0	8	1	0	1	0	0	0	0	0	0	0	0	0	0	10
17:15	1	11	4	0	1	0	0	0	0	0	0	0	0	0	0	17
17:30	0	8	0	0	1	0	0	0	0	0	0	0	0	0	0	9
17:45	0	10	2	0	1	0	0	0	0	0	0	0	0	0	0	13
	1	37	7	0	4	0	0	0	0	0	0	0	0	0	0	49
18:00	1	9	1	0	1	0	0	0	0	0	0	0	0	0	0	12
18:15	0	10	0	0	0	0	0	0	0	0	0	0	0	0	0	10
18:30	0	7	1	0	0	0	0	0	0	0	0	0	0	0	0	8
18:45	1	0	0	0	0	0	0	0	0	0	0	0	0	0	0	1
	2	26	2	0	1	0	0	0	0	0	0	0	0	0	0	31
19:00	0	11	2	0	0	0	0	0	0	0	0	0	0	0	0	13
19:15	0	4	3	0	0	0	0	0	0	0	0	0	0	0	0	7
19:30	0	3	0	0	0	0	0	0	0	0	0	0	0	0	0	3
19:45	0	5	1	0	0	0	0	0	0	0	0	0	0	0	0	6
	0	23	6	0	0	0	0	0	0	0	0	0	0	0	0	29
20:00	0	7	0	0	0	0	0	0	0	0	0	0	0	0	0	7
20:15	0	9	0	0	2	0	0	0	0	0	0	0	0	0	0	11
20:30	0	5	0	0	0	0	0	0	0	0	0	0	0	0	0	5
20:45	0	2	2	0	0	0	0	0	0	0	0	0	0	0	0	4
	0	23	2	0	2	0	0	0	0	0	0	0	0	0	0	27
21:00	0	3	0	0	0	0	0	0	0	0	0	0	0	0	0	3
21:15	0	2	0	0	0	0	0	0	0	0	0	0	0	0	0	2
21:30	0	3	0	0	1	0	0	0	0	0	0	0	0	0	0	4
21:45	0	3	1	0	0	0	0	0	0	0	0	0	0	0	0	4
	0	11	1	0	1	0	0	0	0	0	0	0	0	0	0	13
22:00	0	6	0	0	0	0	0	0	0	0	0	0	0	0	0	6
22:15	0	4	0	0	0	0	0	0	0	0	0	0	0	0	0	4
22:30	0	4	0	0	0	0	0	0	0	0	0	0	0	1	0	5
22:45	0	0	1	0	0	0	0	0	0	0	0	0	0	0	0	1
	0	14	1	0	0	0	0	0	0	0	0	0	0	1	0	16
23:00	0	4	0	0	0	0	0	0	0	0	0	0	0	0	0	4
23:15	0	1	1	0	1	0	0	0	0	0	0	0	0	0	0	3
23:30	0	1	0	0	0	0	0	0	0	0	0	0	0	0	0	1
23:45	0	0	0	0	0	0	0	0	0	0	0	0	0	0	0	0
	0	6	1	0	1	0	0	0	0	0	0	0	0	0	0	8
Total	6	345	56	5	16	1	0	2	0	0	0	0	0	2	0	433
Percent	1.4%	79.7%	12.9%	1.2%	3.7%	0.2%	0.0%	0.5%	0.0%	0.0%	0.0%	0.0%	0.0%	0.5%	0.0%	

Tri-State Traffic Data, Inc

184 Baker Rd
Coatesville, PA 19320

Site Code: Chandler Ln
Station ID: 000000000000
41.514692, -74.248965

Latitude: 0' 0.0000 Undefined

Direction 1 East

Start Time	Class 1	Class 2	Class 3	Class 4	Class 5	Class 6	Class 7	Class 8	Class 9	Class 10	Class 11	Class 12	Class 13	Class 14	Class 15	Total
12 PM	0	10	2	0	1	0	0	0	0	0	0	0	0	0	0	13
12:15	0	5	5	0	1	1	0	0	0	0	0	0	0	0	0	12
12:30	0	5	1	0	0	1	0	0	0	0	0	0	0	0	0	7
12:45	0	9	2	0	0	0	0	1	0	0	0	0	0	0	0	12
	0	29	10	0	2	2	0	1	0	0	0	0	0	0	0	44
13:00	0	5	1	0	0	0	0	1	0	0	0	0	0	0	0	7
13:15	0	9	0	0	0	0	0	0	0	0	0	0	0	0	0	9
13:30	0	6	3	0	0	0	0	1	0	0	0	0	0	0	0	10
13:45	0	5	3	0	0	0	0	0	0	0	0	0	0	0	0	8
	0	25	7	0	0	0	0	2	0	0	0	0	0	0	0	34
14:00	0	8	3	0	0	0	0	0	0	0	0	0	0	0	0	11
14:15	0	3	0	0	1	0	0	0	0	0	0	0	0	0	0	4
14:30	0	11	1	0	0	0	0	1	0	0	0	0	0	0	0	13
14:45	0	5	0	0	0	0	0	1	0	0	0	0	0	0	0	6
	0	27	4	0	1	0	0	2	0	0	0	0	0	0	0	34
15:00	0	14	1	1	0	1	0	0	0	0	0	0	0	0	0	17
15:15	0	18	1	0	0	0	0	0	0	0	0	0	0	0	0	19
15:30	0	12	2	1	1	0	0	0	0	0	0	0	0	0	0	16
15:45	0	13	0	2	0	0	0	0	0	0	0	0	0	0	0	15
	0	57	4	4	1	1	0	0	0	0	0	0	0	0	0	67
16:00	0	4	1	1	0	0	0	0	0	0	0	0	0	0	0	6
16:15	0	9	4	1	0	0	0	0	0	0	0	0	0	0	0	14
16:30	0	20	0	0	0	0	0	0	0	0	0	0	0	0	0	20
16:45	0	10	0	0	0	0	0	0	0	0	0	0	0	0	0	10
	0	43	5	2	0	0	0	0	0	0	0	0	0	0	0	50
17:00	0	10	3	0	0	0	0	0	0	0	0	0	0	0	0	13
17:15	0	5	3	0	0	0	0	0	0	0	0	0	0	0	0	8
17:30	2	13	1	0	0	0	0	0	0	0	0	0	0	1	0	17
17:45	0	8	3	0	0	0	0	0	0	0	0	0	0	0	0	11
	2	36	10	0	0	0	0	0	0	0	0	0	0	1	0	49
18:00	0	8	2	0	0	0	0	0	0	0	0	0	0	0	0	10
18:15	0	14	1	0	0	0	0	0	0	0	0	0	0	0	0	15
18:30	0	7	0	0	0	0	0	0	0	0	0	0	0	0	0	7
18:45	0	8	2	0	0	0	0	0	0	0	0	0	0	0	0	10
	0	37	5	0	0	0	0	0	0	0	0	0	0	0	0	42
19:00	1	9	1	0	1	0	0	0	0	0	0	0	0	0	0	12
19:15	0	7	0	0	0	0	0	0	0	0	0	0	0	0	0	7
19:30	0	9	0	0	0	0	0	0	0	0	0	0	0	0	0	9
19:45	0	1	0	0	0	0	0	0	0	0	0	0	0	0	0	1
	1	26	1	0	1	0	0	0	0	0	0	0	0	0	0	29
20:00	0	7	2	0	0	0	0	0	0	0	0	0	0	0	0	9
20:15	1	9	1	0	0	0	0	0	0	0	0	0	0	0	0	11
20:30	0	8	1	0	0	0	0	0	0	0	0	0	0	0	0	9
20:45	0	2	2	0	0	0	0	0	0	0	0	0	0	0	0	4
	1	26	6	0	0	0	0	0	0	0	0	0	0	0	0	33
21:00	0	6	0	0	0	0	0	0	0	0	0	0	0	0	0	6
21:15	0	5	1	0	0	0	0	0	0	0	0	0	0	0	0	6
21:30	0	3	0	0	1	0	0	0	0	0	0	0	0	0	0	4
21:45	0	4	0	0	0	0	0	0	0	0	0	0	0	0	0	4
	0	18	1	0	1	0	0	0	0	0	0	0	0	0	0	20
22:00	0	5	1	0	0	0	0	0	0	0	0	0	0	0	0	6
22:15	0	2	0	0	0	0	0	0	0	0	0	0	0	0	0	2
22:30	0	2	1	0	0	0	0	0	0	0	0	0	0	0	0	3
22:45	0	4	1	0	0	0	0	0	0	0	0	0	0	0	0	5
	0	13	3	0	0	0	0	0	0	0	0	0	0	0	0	16
23:00	0	2	0	0	0	0	0	0	0	0	0	0	0	0	0	2
23:15	0	1	0	0	0	0	0	0	0	0	0	0	0	0	0	1
23:30	0	0	0	0	0	0	0	0	0	0	0	0	0	0	0	0
23:45	0	6	1	0	0	0	0	0	0	0	0	0	0	0	0	7
	0	9	1	0	0	0	0	0	0	0	0	0	0	0	0	10
Total	4	346	57	6	6	3	0	5	0	0	0	0	0	1	0	428
Percent	0.9%	80.8%	13.3%	1.4%	1.4%	0.7%	0.0%	1.2%	0.0%	0.0%	0.0%	0.0%	0.0%	0.2%	0.0%	

Tri-State Traffic Data, Inc

184 Baker Rd
Coatesville, PA 19320

Site Code: Chandler Ln
Station ID: 00000000000
41.514692, -74.248965

Latitude: 0' 0.0000 Undefined

Direction 1 East

Start Time	Class 1	Class 2	Class 3	Class 4	Class 5	Class 6	Class 7	Class 8	Class 9	Class 10	Class 11	Class 12	Class 13	Class 14	Class 15	Total
06/09/1	9	0	3	0	0	0	0	0	0	0	0	0	0	0	0	3
00:15	0	4	0	0	0	0	0	0	0	0	0	0	0	0	0	4
00:30	0	1	1	0	0	0	0	0	0	0	0	0	0	0	0	2
00:45	0	1	0	0	0	0	0	0	0	0	0	0	0	0	0	1
	0	9	1	0	0	0	0	0	0	0	0	0	0	0	0	10
01:00	0	1	1	0	0	0	0	0	0	0	0	0	0	0	0	2
01:15	0	2	0	0	0	0	0	0	0	0	0	0	0	0	0	2
01:30	0	0	1	0	0	0	0	0	0	0	0	0	0	0	0	1
01:45	0	1	0	0	0	0	0	0	0	0	0	0	0	0	0	1
	0	4	2	0	0	0	0	0	0	0	0	0	0	0	0	6
02:00	0	0	0	0	0	0	0	0	0	0	0	0	0	0	0	0
02:15	0	0	0	0	0	0	0	0	0	0	0	0	0	0	0	0
02:30	0	1	0	0	0	0	0	0	0	0	0	0	0	0	0	1
02:45	0	0	0	0	0	0	0	0	0	0	0	0	0	0	0	0
	0	1	0	0	0	0	0	0	0	0	0	0	0	0	0	1
03:00	0	0	0	0	0	0	0	0	0	0	0	0	0	0	0	0
03:15	0	0	0	0	0	0	0	0	0	0	0	0	0	0	0	0
03:30	0	1	0	0	0	0	0	0	0	0	0	0	0	0	0	1
03:45	0	0	0	0	0	0	0	0	0	0	0	0	0	0	0	0
	0	1	0	0	0	0	0	0	0	0	0	0	0	0	0	1
04:00	0	0	0	0	0	0	0	0	0	0	0	0	0	0	0	0
04:15	0	0	0	0	0	0	0	0	0	0	0	0	0	0	0	0
04:30	0	1	0	0	0	0	0	0	0	0	0	0	0	0	0	1
04:45	0	0	0	0	0	0	0	0	0	0	0	0	0	0	0	0
	0	1	0	0	0	0	0	0	0	0	0	0	0	0	0	1
05:00	0	1	1	0	0	0	0	0	0	0	0	0	0	0	0	2
05:15	0	1	0	0	0	0	0	0	0	0	0	0	0	0	0	1
05:30	0	1	0	0	0	0	0	0	0	0	0	0	0	0	0	1
05:45	0	2	0	0	0	0	0	0	0	0	0	0	0	0	0	2
	0	5	1	0	0	0	0	0	0	0	0	0	0	0	0	6
06:00	0	0	0	0	0	0	0	0	0	0	0	0	0	0	0	0
06:15	0	0	0	0	0	0	0	0	0	0	0	0	0	0	0	0
06:30	0	0	0	0	0	0	0	0	0	0	0	0	0	0	0	0
06:45	0	0	0	0	0	0	0	0	0	0	0	0	0	0	0	0
	0	0	0	0	0	0	0	0	0	0	0	0	0	0	0	0
07:00	0	0	0	0	0	0	0	0	0	0	0	0	0	0	0	0
07:15	0	2	0	0	0	0	0	0	0	0	0	0	0	0	0	2
07:30	0	1	0	0	0	0	0	0	0	0	0	0	0	0	0	1
07:45	0	2	0	0	0	0	0	0	0	0	0	0	0	0	0	2
	0	5	0	0	0	0	0	0	0	0	0	0	0	0	0	5
08:00	0	1	0	0	0	0	0	0	0	0	0	0	0	0	0	1
08:15	0	2	0	0	0	0	0	0	0	0	0	0	0	0	0	2
08:30	0	4	1	0	0	0	0	0	0	0	0	0	0	0	0	5
08:45	0	1	0	0	0	0	0	0	0	0	0	0	0	0	0	1
	0	8	1	0	0	0	0	0	0	0	0	0	0	0	0	9
09:00	0	3	1	0	0	0	0	0	0	0	0	0	0	0	0	4
09:15	0	2	0	0	0	0	0	0	0	0	0	0	0	0	0	2
09:30	0	5	1	0	0	0	0	0	0	0	0	0	0	0	0	6
09:45	0	7	1	0	0	0	0	0	0	0	0	0	0	0	0	8
	0	17	3	0	0	0	0	0	0	0	0	0	0	0	0	20
10:00	0	5	0	0	0	0	0	0	0	0	0	0	0	0	0	5
10:15	0	3	1	0	0	0	0	0	0	0	0	0	0	0	0	4
10:30	0	3	0	0	0	0	0	0	0	0	0	0	0	0	0	3
10:45	0	7	0	0	0	0	0	0	0	0	0	0	0	0	0	7
	0	18	1	0	0	0	0	0	0	0	0	0	0	0	0	19
11:00	0	3	0	0	0	0	0	0	0	0	0	0	0	0	0	3
11:15	0	4	0	0	0	0	0	0	0	0	0	0	0	0	0	4
11:30	0	8	0	0	0	0	0	0	0	0	0	0	0	0	0	8
11:45	0	7	1	0	0	0	0	0	0	0	0	0	0	1	0	9
	0	22	1	0	0	0	0	0	0	0	0	0	0	1	0	24
Total	0	91	10	0	0	0	0	0	0	0	0	0	0	1	0	102
Percent	0.0%	89.2%	9.8%	0.0%	0.0%	0.0%	0.0%	0.0%	0.0%	0.0%	0.0%	0.0%	0.0%	1.0%	0.0%	

Tri-State Traffic Data, Inc

184 Baker Rd
Coatesville, PA 19320

Site Code: Chandler Ln
Station ID: 000000000000
41.514692, -74.248965

Latitude: 0' 0.0000 Undefined

Direction 1 East

Start Time	Class 1	Class 2	Class 3	Class 4	Class 5	Class 6	Class 7	Class 8	Class 9	Class 10	Class 11	Class 12	Class 13	Class 14	Class 15	Total
12 PM	1	6	1	0	0	0	0	0	0	0	0	0	0	0	0	8
12:15	0	9	2	0	0	0	0	0	0	0	0	0	0	0	0	11
12:30	0	8	1	0	0	0	0	0	0	0	0	0	0	0	0	9
12:45	0	10	1	0	0	0	0	0	0	0	0	0	0	0	0	11
	1	33	5	0	0	0	0	0	0	0	0	0	0	0	0	39
13:00	0	5	1	0	0	0	0	0	0	0	0	0	0	0	0	6
13:15	0	12	2	0	0	0	0	0	0	0	0	0	0	0	0	14
13:30	0	8	1	0	0	0	0	0	0	0	0	0	0	0	0	9
13:45	0	8	2	0	0	0	0	0	0	0	0	0	0	0	0	10
	0	33	6	0	0	0	0	0	0	0	0	0	0	0	0	39
14:00	1	6	3	0	0	0	0	0	0	0	0	0	0	0	0	10
14:15	2	12	4	0	0	0	0	0	0	0	0	0	0	0	0	18
14:30	0	5	0	0	0	0	0	0	0	0	0	0	0	0	0	5
14:45	0	7	1	0	0	0	0	0	0	0	0	0	0	0	1	9
	3	30	8	0	0	0	0	0	0	0	0	0	0	1	0	42
15:00	0	2	2	0	0	0	0	0	0	0	0	0	0	0	0	4
15:15	0	6	1	0	0	0	0	0	0	0	0	0	0	0	0	7
15:30	0	17	1	0	0	0	0	0	0	0	0	0	0	0	0	18
15:45	0	5	4	0	0	0	0	0	0	0	0	0	0	0	0	9
	0	30	8	0	0	0	0	0	0	0	0	0	0	0	0	38
16:00	0	15	1	0	0	0	0	0	0	0	0	0	0	0	0	16
16:15	0	4	1	0	0	0	0	0	0	0	0	0	0	0	0	5
16:30	0	9	1	0	0	0	0	0	0	0	0	0	0	0	0	10
16:45	0	12	1	0	0	0	0	0	0	0	0	0	0	0	0	13
	0	40	4	0	0	0	0	0	0	0	0	0	0	0	0	44
17:00	0	11	1	0	0	0	0	0	0	0	0	0	0	0	0	12
17:15	0	10	3	0	0	0	0	0	0	0	0	0	0	0	0	13
17:30	0	7	0	0	0	0	0	0	0	0	0	0	0	0	0	7
17:45	1	3	1	0	0	0	0	0	0	0	0	0	0	0	0	5
	1	31	5	0	0	0	0	0	0	0	0	0	0	0	0	37
18:00	0	3	2	0	0	0	0	0	0	0	0	0	0	0	0	5
18:15	0	3	2	0	1	0	0	0	0	0	0	0	0	0	0	6
18:30	0	8	0	0	0	0	0	0	0	0	0	0	0	0	0	8
18:45	0	3	0	0	0	0	0	0	0	0	0	0	0	0	0	3
	0	17	4	0	1	0	0	0	0	0	0	0	0	0	0	22
19:00	0	9	0	0	0	0	0	0	0	0	0	0	0	0	0	9
19:15	0	5	1	0	0	0	0	0	0	0	0	0	0	0	0	6
19:30	0	4	2	0	0	0	0	0	0	0	0	0	0	0	0	6
19:45	0	6	3	0	0	0	0	0	0	0	0	0	0	0	0	9
	0	24	6	0	0	0	0	0	0	0	0	0	0	0	0	30
20:00	0	6	0	0	0	0	0	0	0	0	0	0	0	0	0	6
20:15	0	5	1	0	1	0	0	0	0	0	0	0	0	0	0	7
20:30	0	7	0	0	0	0	0	0	0	0	0	0	0	0	0	7
20:45	0	2	1	0	0	0	0	0	0	0	0	0	0	0	0	3
	0	20	2	0	1	0	0	0	0	0	0	0	0	0	0	23
21:00	0	3	2	0	0	0	0	0	0	0	0	0	0	0	0	5
21:15	0	0	0	0	0	0	0	0	0	0	0	0	0	0	0	0
21:30	0	5	0	0	0	0	0	0	0	0	0	0	0	0	0	5
21:45	0	3	0	0	0	0	0	0	0	0	0	0	0	0	0	3
	0	11	2	0	0	0	0	0	0	0	0	0	0	0	0	13
22:00	0	0	0	0	0	0	0	0	0	0	0	0	0	0	0	0
22:15	0	2	0	0	0	0	0	0	0	0	0	0	0	0	0	2
22:30	0	3	0	0	0	0	0	0	0	0	0	0	0	0	0	3
22:45	0	1	0	0	0	0	0	0	0	0	0	0	0	0	0	1
	0	6	0	0	0	0	0	0	0	0	0	0	0	0	0	6
23:00	0	0	1	0	0	0	0	0	0	0	0	0	0	0	0	1
23:15	0	2	0	0	0	0	0	0	0	0	0	0	0	0	0	2
23:30	0	1	0	0	0	0	0	0	0	0	0	0	0	0	0	1
23:45	0	1	0	0	0	0	0	0	0	0	0	0	0	0	0	1
	0	4	1	0	0	0	0	0	0	0	0	0	0	0	0	5
Total	5	279	51	0	2	0	0	0	0	0	0	0	0	1	0	338
Percent	1.5%	82.5%	15.1%	0.0%	0.6%	0.0%	0.0%	0.0%	0.0%	0.0%	0.0%	0.0%	0.0%	0.3%	0.0%	

Tri-State Traffic Data, Inc

184 Baker Rd
Coatesville, PA 19320

Site Code: Chandler Ln
Station ID: 000000000000
41.514692, -74.248965

Latitude: 0' 0.0000 Undefined

Direction 1 East

Start Time	Class 1	Class 2	Class 3	Class 4	Class 5	Class 6	Class 7	Class 8	Class 9	Class 10	Class 11	Class 12	Class 13	Class 14	Class 15	Total
06/10/1																
9	0	0	0	0	0	0	0	0	0	0	0	0	0	0	0	0
00:15	0	0	0	0	0	0	0	0	0	0	0	0	0	0	0	0
00:30	0	1	0	0	0	0	0	0	0	0	0	0	0	0	0	1
00:45	0	1	0	0	0	0	0	0	0	0	0	0	0	0	0	1
	0	2	0	0	0	0	0	0	0	0	0	0	0	0	0	2
01:00	0	1	0	0	0	0	0	0	0	0	0	0	0	0	0	1
01:15	0	0	0	0	0	0	0	0	0	0	0	0	0	0	0	0
01:30	0	0	0	0	0	0	0	0	0	0	0	0	0	0	0	0
01:45	0	0	0	0	1	0	0	0	0	0	0	0	0	0	0	1
	0	1	0	0	1	0	0	0	0	0	0	0	0	0	0	2
02:00	0	1	0	0	0	0	0	0	0	0	0	0	0	0	0	1
02:15	0	2	0	0	0	0	0	0	0	0	0	0	0	0	0	2
02:30	0	0	0	0	0	0	0	0	0	0	0	0	0	0	0	0
02:45	0	0	0	0	0	0	0	0	0	0	0	0	0	0	0	0
	0	3	0	0	0	0	0	0	0	0	0	0	0	0	0	3
03:00	0	0	0	0	0	0	0	0	0	0	0	0	0	0	0	0
03:15	0	1	0	0	0	0	0	0	0	0	0	0	0	0	0	1
03:30	0	1	0	0	0	0	0	0	0	0	0	0	0	0	0	1
03:45	0	0	0	0	0	0	0	0	0	0	0	0	0	0	0	0
	0	2	0	0	0	0	0	0	0	0	0	0	0	0	0	2
04:00	0	0	0	0	0	0	0	0	0	0	0	0	0	0	0	0
04:15	0	1	0	0	0	0	0	0	0	0	0	0	0	0	0	1
04:30	0	0	0	0	0	0	0	0	0	0	0	0	0	0	0	0
04:45	0	0	0	0	0	0	0	0	0	0	0	0	0	0	0	0
	0	1	0	0	0	0	0	0	0	0	0	0	0	0	0	1
05:00	0	0	0	0	0	0	0	0	0	0	0	0	0	0	0	0
05:15	0	0	0	0	0	0	0	0	0	0	0	0	0	0	0	0
05:30	0	0	0	0	0	0	0	0	0	0	0	0	0	0	0	0
05:45	0	1	0	0	0	0	0	0	0	0	0	0	0	0	0	1
	0	1	0	0	0	0	0	0	0	0	0	0	0	0	0	1
06:00	0	3	0	0	0	0	0	0	0	0	0	0	0	0	0	3
06:15	0	0	0	0	0	0	0	0	0	0	0	0	0	0	0	0
06:30	0	4	2	0	0	0	0	0	0	0	0	0	0	0	0	6
06:45	0	4	0	1	0	0	0	0	0	0	0	0	0	0	0	5
	0	11	2	1	0	0	0	0	0	0	0	0	0	0	0	14
07:00	0	1	1	0	0	0	0	0	0	0	0	0	0	0	0	2
07:15	0	0	0	0	0	0	0	0	0	0	0	0	0	0	0	0
07:30	*	*	*	*	*	*	*	*	*	*	*	*	*	*	*	*
07:45	*	*	*	*	*	*	*	*	*	*	*	*	*	*	*	*
	0	0	0	0	0	0	0	0	0	0	0	0	0	0	0	0
08:00	*	*	*	*	*	*	*	*	*	*	*	*	*	*	*	*
08:15	*	*	*	*	*	*	*	*	*	*	*	*	*	*	*	*
08:30	*	*	*	*	*	*	*	*	*	*	*	*	*	*	*	*
08:45	*	*	*	*	*	*	*	*	*	*	*	*	*	*	*	*
	0	0	0	0	0	0	0	0	0	0	0	0	0	0	0	0
09:00	*	*	*	*	*	*	*	*	*	*	*	*	*	*	*	*
09:15	*	*	*	*	*	*	*	*	*	*	*	*	*	*	*	*
09:30	*	*	*	*	*	*	*	*	*	*	*	*	*	*	*	*
09:45	*	*	*	*	*	*	*	*	*	*	*	*	*	*	*	*
	0	0	0	0	0	0	0	0	0	0	0	0	0	0	0	0
10:00	*	*	*	*	*	*	*	*	*	*	*	*	*	*	*	*
10:15	*	*	*	*	*	*	*	*	*	*	*	*	*	*	*	*
10:30	*	*	*	*	*	*	*	*	*	*	*	*	*	*	*	*
10:45	*	*	*	*	*	*	*	*	*	*	*	*	*	*	*	*
	0	0	0	0	0	0	0	0	0	0	0	0	0	0	0	0
11:00	*	*	*	*	*	*	*	*	*	*	*	*	*	*	*	*
11:15	*	*	*	*	*	*	*	*	*	*	*	*	*	*	*	*
11:30	*	*	*	*	*	*	*	*	*	*	*	*	*	*	*	*
11:45	*	*	*	*	*	*	*	*	*	*	*	*	*	*	*	*
	0	0	0	0	0	0	0	0	0	0	0	0	0	0	0	0
Total	0	22	3	1	1	0	0	0	0	0	0	0	0	0	0	27
Percent	0.0%	81.5%	11.1%	3.7%	3.7%	0.0%	0.0%	0.0%	0.0%	0.0%	0.0%	0.0%	0.0%	0.0%	0.0%	
Grand Total	21	2179	377	31	66	9	0	12	0	0	0	0	0	5	0	2700
Percent	0.8%	80.7%	14.0%	1.1%	2.4%	0.3%	0.0%	0.4%	0.0%	0.0%	0.0%	0.0%	0.0%	0.2%	0.0%	

Tri-State Traffic Data, Inc

184 Baker Rd
Coatesville, PA 19320

Site Code: Chandler Ln
Station ID: 000000000000
41.514692, -74.248965

Latitude: 0' 0.0000 Undefined

Direction 2 West

Start Time	Class 1	Class 2	Class 3	Class 4	Class 5	Class 6	Class 7	Class 8	Class 9	Class 10	Class 11	Class 12	Class 13	Class 14	Class 15	Total
06/06/1																
9	0	0	0	0	0	0	0	0	0	0	0	0	0	0	0	0
00:15	0	0	0	0	0	0	0	0	0	0	0	0	0	0	0	0
00:30	0	0	0	0	0	0	0	0	0	0	0	0	0	0	0	0
00:45	0	0	0	0	0	0	0	0	0	0	0	0	0	0	0	0
01:00	0	1	0	0	0	0	0	0	0	0	0	0	0	0	0	1
01:15	0	0	0	0	0	0	0	0	0	0	0	0	0	0	0	0
01:30	0	0	0	0	0	0	0	0	0	0	0	0	0	0	0	0
01:45	0	0	0	0	0	0	0	0	0	0	0	0	0	0	0	0
02:00	0	1	0	0	0	0	0	0	0	0	0	0	0	0	0	1
02:15	0	0	0	0	0	0	0	0	0	0	0	0	0	0	0	0
02:30	0	1	0	0	0	0	0	0	0	0	0	0	0	0	0	1
02:45	0	2	0	0	0	0	0	0	0	0	0	0	0	0	0	2
03:00	0	0	0	0	0	0	0	0	0	0	0	0	0	0	0	0
03:15	0	0	0	0	0	0	0	0	0	0	0	0	0	0	0	0
03:30	0	0	0	0	0	0	0	0	0	0	0	0	0	0	0	0
03:45	0	0	0	0	0	0	0	0	0	0	0	0	0	0	0	0
04:00	0	1	0	0	0	0	0	0	0	0	0	0	0	0	0	1
04:15	0	1	1	0	0	0	0	0	0	0	0	0	0	0	0	2
04:30	0	0	0	0	0	0	0	0	0	0	0	0	0	0	0	0
04:45	0	2	0	0	0	0	0	0	0	0	0	0	0	0	0	2
05:00	0	4	1	0	0	0	0	0	0	0	0	0	0	0	0	5
05:15	0	2	0	0	0	0	0	0	0	0	0	0	0	0	0	2
05:30	0	1	1	0	0	0	0	0	0	0	0	0	0	0	0	2
05:45	0	0	0	0	1	0	0	0	0	0	0	0	0	0	0	1
06:00	0	2	2	0	0	0	0	0	0	0	0	0	0	0	0	4
06:15	0	5	3	0	1	0	0	0	0	0	0	0	0	0	0	9
06:30	0	3	0	0	0	0	0	0	0	0	0	0	0	0	0	3
06:45	0	4	2	0	0	0	0	0	0	0	0	0	0	0	0	6
07:00	0	8	0	0	1	0	0	0	0	0	0	0	0	0	0	9
07:15	0	8	3	0	0	0	0	0	0	0	0	0	0	0	0	11
07:30	0	23	5	0	1	0	0	0	0	0	0	0	0	0	0	29
07:45	0	6	2	0	1	0	0	0	0	0	0	0	0	0	0	9
08:00	0	10	1	0	0	0	0	0	0	0	0	0	0	0	0	11
08:15	0	12	2	0	0	0	0	0	0	0	0	0	0	0	0	14
08:30	0	11	0	0	0	0	0	0	0	0	0	0	0	1	0	12
08:45	0	39	5	0	1	0	0	0	0	0	0	0	0	1	0	46
09:00	0	1	1	1	2	0	0	0	0	0	0	0	0	0	0	5
09:15	1	8	2	0	1	0	0	0	0	0	0	0	0	0	0	12
09:30	0	8	1	0	0	0	0	0	0	0	0	0	0	0	0	9
09:45	1	10	4	2	0	0	0	0	0	0	0	0	0	0	0	17
10:00	2	27	8	3	3	0	0	0	0	0	0	0	0	0	0	43
10:15	0	6	5	0	0	0	0	0	0	0	0	0	0	0	0	11
10:30	0	4	4	0	0	0	0	0	0	0	0	0	0	0	0	8
10:45	0	7	1	0	1	0	0	0	0	0	0	0	0	0	0	9
11:00	0	6	2	0	0	0	0	0	0	0	0	0	0	0	0	8
11:15	0	23	12	0	1	0	0	0	0	0	0	0	0	0	0	36
11:30	0	4	1	0	0	0	0	0	0	0	0	0	0	0	0	5
11:45	0	6	0	0	1	0	0	0	0	0	0	0	0	0	0	7
12:00	0	4	4	0	0	0	0	0	0	0	0	0	0	0	0	8
12:15	0	5	3	0	0	0	0	0	0	0	0	0	0	0	0	8
12:30	0	19	8	0	1	0	0	0	0	0	0	0	0	0	0	28
12:45	0	5	1	0	0	0	0	0	0	0	0	0	0	0	0	6
13:00	0	8	1	0	0	0	0	0	0	0	0	0	0	0	0	9
13:15	0	7	7	0	0	0	0	0	0	0	0	0	0	0	0	14
13:30	1	5	1	0	0	0	0	0	0	0	0	0	0	0	0	7
13:45	1	25	10	0	0	0	0	0	0	0	0	0	0	0	0	36
Total	3	168	52	3	8	0	0	0	0	0	0	0	0	1	0	235
Percent	1.3%	71.5%	22.1%	1.3%	3.4%	0.0%	0.0%	0.0%	0.0%	0.0%	0.0%	0.0%	0.0%	0.4%	0.0%	

Tri-State Traffic Data, Inc

184 Baker Rd
Coatesville, PA 19320

Site Code: Chandler Ln
Station ID: 000000000000
41.514692, -74.248965

Latitude: 0' 0.0000 Undefined

Direction 2 West

Start Time	Class 1	Class 2	Class 3	Class 4	Class 5	Class 6	Class 7	Class 8	Class 9	Class 10	Class 11	Class 12	Class 13	Class 14	Class 15	Total
12 PM	0	5	0	0	0	1	0	0	0	0	0	0	0	0	0	6
12:15	0	5	2	0	1	0	0	0	0	0	0	0	0	0	0	8
12:30	0	8	2	0	0	0	0	0	0	0	0	0	0	0	0	10
12:45	0	5	1	0	0	0	0	0	0	0	0	0	0	0	0	6
	0	23	5	0	1	1	0	0	0	0	0	0	0	0	0	30
13:00	1	6	1	0	0	0	0	2	0	1	0	0	0	0	0	11
13:15	0	4	4	0	1	0	0	0	0	0	0	0	0	1	0	10
13:30	0	8	1	0	0	0	0	0	0	0	0	0	0	0	0	9
13:45	0	12	0	0	0	0	0	0	0	0	0	0	0	0	0	12
	1	30	6	0	1	0	0	2	0	1	0	0	0	1	0	42
14:00	0	9	3	1	0	0	0	0	0	1	0	0	0	0	0	14
14:15	0	8	2	0	0	0	0	0	0	0	0	0	0	0	0	10
14:30	0	10	1	0	0	0	0	0	0	0	0	0	0	0	0	11
14:45	1	8	2	0	0	0	0	0	0	0	0	0	0	0	0	11
	1	35	8	1	0	0	0	0	1	0	0	0	0	0	0	46
15:00	0	10	0	0	0	0	0	1	0	0	0	0	0	0	0	11
15:15	0	4	2	0	0	0	0	0	0	0	0	0	0	0	0	6
15:30	0	12	1	0	0	0	0	0	0	0	0	0	0	0	0	13
15:45	0	6	1	0	0	0	0	0	0	0	0	0	0	0	0	7
	0	32	4	0	0	0	0	1	0	0	0	0	0	0	0	37
16:00	0	10	1	0	0	0	0	0	0	0	0	0	0	0	0	11
16:15	0	16	2	0	0	0	0	0	0	0	0	0	0	0	0	18
16:30	0	8	2	0	0	0	0	0	0	0	0	0	0	0	0	10
16:45	0	7	2	0	1	0	0	0	0	0	0	0	0	0	0	10
	0	41	7	0	1	0	0	0	0	0	0	0	0	0	0	49
17:00	0	9	2	0	0	0	0	0	0	0	0	0	0	0	0	11
17:15	1	4	2	0	0	0	0	0	0	0	0	0	0	0	0	7
17:30	0	8	2	0	0	0	0	0	0	0	0	0	0	0	0	10
17:45	0	9	1	0	0	0	0	0	0	0	0	0	0	0	0	10
	1	30	7	0	0	0	0	0	0	0	0	0	0	0	0	38
18:00	0	11	2	0	0	0	0	0	0	0	0	0	0	0	0	13
18:15	0	11	2	0	0	0	0	0	0	0	0	0	0	0	0	13
18:30	0	5	0	0	0	0	0	0	0	0	0	0	0	0	0	5
18:45	0	3	2	0	0	0	0	0	0	0	0	0	0	0	0	5
	0	30	6	0	0	0	0	0	0	0	0	0	0	0	0	36
19:00	0	4	1	0	0	0	0	0	0	0	0	0	0	0	0	5
19:15	0	3	2	0	0	0	0	0	0	0	0	0	0	0	0	5
19:30	0	12	0	0	1	0	0	0	0	0	0	0	0	0	0	13
19:45	0	6	2	0	0	0	0	0	0	0	0	0	0	0	0	8
	0	25	5	0	1	0	0	0	0	0	0	0	0	0	0	31
20:00	0	4	1	0	0	1	0	0	0	0	0	0	0	0	0	6
20:15	0	6	1	0	1	0	0	0	0	0	0	0	0	0	0	8
20:30	0	4	0	0	0	0	0	0	0	0	0	0	0	0	0	4
20:45	0	6	0	0	0	0	0	0	0	0	0	0	0	0	0	6
	0	20	2	0	1	1	0	0	0	0	0	0	0	0	0	24
21:00	0	4	2	0	0	0	0	0	0	0	0	0	0	0	0	4
21:15	0	2	0	0	0	0	0	0	0	0	0	0	0	0	0	2
21:30	0	1	2	0	0	0	0	0	0	0	0	0	0	0	0	3
21:45	0	1	1	0	0	0	0	0	0	0	0	0	0	0	0	2
	0	8	3	0	0	0	0	0	0	0	0	0	0	0	0	11
22:00	0	1	1	0	0	0	0	0	0	0	0	0	0	0	0	2
22:15	0	1	0	0	0	0	0	0	0	0	0	0	0	0	0	1
22:30	0	5	0	0	0	0	0	0	0	0	0	0	0	0	0	5
22:45	0	2	0	0	0	0	0	0	0	0	0	0	0	0	0	2
	0	9	1	0	0	0	0	0	0	0	0	0	0	0	0	10
23:00	0	0	0	0	0	0	0	0	0	0	0	0	0	0	0	0
23:15	0	1	0	0	0	0	0	0	0	0	0	0	0	0	0	1
23:30	0	1	0	0	0	0	0	0	0	0	0	0	0	0	0	1
23:45	0	0	0	0	0	0	0	0	0	0	0	0	0	0	0	0
	0	2	0	0	0	0	0	0	0	0	0	0	0	0	0	2
Total	3	285	54	1	5	2	0	3	0	2	0	0	0	1	0	356
Percent	0.8%	80.1%	15.2%	0.3%	1.4%	0.6%	0.0%	0.8%	0.0%	0.6%	0.0%	0.0%	0.0%	0.3%	0.0%	

Tri-State Traffic Data, Inc

184 Baker Rd
Coatesville, PA 19320

Site Code: Chandler Ln
Station ID: 000000000000
41.514692, -74.248965

Latitude: 0' 0.0000 Undefined

Direction 2 West

Start Time	Class 1	Class 2	Class 3	Class 4	Class 5	Class 6	Class 7	Class 8	Class 9	Class 10	Class 11	Class 12	Class 13	Class 14	Class 15	Total
06/10/1																
9	0	0	0	0	0	0	0	0	0	0	0	0	0	0	0	0
00:15	0	0	0	0	0	0	0	0	0	0	0	0	0	0	0	0
00:30	0	0	0	0	0	0	0	0	0	0	0	0	0	0	0	0
00:45	0	0	0	0	0	0	0	0	0	0	0	0	0	0	0	0
01:00	0	0	0	0	0	0	0	0	0	0	0	0	0	0	0	0
01:15	0	0	0	0	0	0	0	0	0	0	0	0	0	0	0	0
01:30	0	0	0	0	0	0	0	0	0	0	0	0	0	0	0	0
01:45	0	0	0	0	0	0	0	0	0	0	0	0	0	0	0	0
02:00	0	0	0	0	0	0	0	0	0	0	0	0	0	0	0	0
02:15	0	1	0	0	0	0	0	0	0	0	0	0	0	0	0	1
02:30	0	0	0	0	0	0	0	0	0	0	0	0	0	0	0	0
02:45	0	0	0	0	0	0	0	0	0	0	0	0	0	0	0	0
03:00	0	1	0	0	0	0	0	0	0	0	0	0	0	0	0	1
03:15	0	2	0	0	0	0	0	0	0	0	0	0	0	0	0	2
03:30	0	0	0	0	0	0	0	0	0	0	0	0	0	0	0	0
03:45	0	0	0	0	0	0	0	0	0	0	0	0	0	0	0	0
04:00	0	3	0	0	0	0	0	0	0	0	0	0	0	0	0	3
04:15	0	1	1	0	0	0	0	0	0	0	0	0	0	0	0	2
04:30	0	2	0	0	0	0	0	0	0	0	0	0	0	0	0	2
04:45	0	1	0	0	0	0	0	0	0	0	0	0	0	0	0	1
05:00	0	5	1	0	1	0	0	0	0	0	0	0	0	0	0	7
05:15	0	1	1	0	0	0	0	0	0	0	0	0	0	0	0	2
05:30	0	2	1	0	0	0	0	0	0	0	0	0	0	1	0	4
05:45	0	0	0	0	0	0	0	0	0	0	0	0	0	0	0	0
06:00	0	1	3	0	0	0	0	0	0	0	0	0	0	0	0	4
06:15	0	4	5	0	0	0	0	0	0	0	0	0	0	1	0	10
06:30	0	2	1	0	0	0	0	0	0	0	0	0	0	0	0	3
06:45	0	5	0	0	0	0	0	0	0	0	0	0	0	0	0	5
07:00	0	4	2	0	0	0	0	0	0	0	0	0	0	0	0	6
07:15	0	6	3	0	0	0	0	0	0	0	0	0	0	0	0	9
07:30	0	17	6	0	0	0	0	0	0	0	0	0	0	0	0	23
07:45	0	8	2	0	1	0	0	0	0	0	0	0	0	0	0	11
08:00	*	1	0	0	0	0	0	0	0	0	0	0	0	0	0	1
08:15	*	*	*	*	*	*	*	*	*	*	*	*	*	*	*	*
08:30	*	*	*	*	*	*	*	*	*	*	*	*	*	*	*	*
08:45	*	*	*	*	*	*	*	*	*	*	*	*	*	*	*	*
09:00	0	0	0	0	0	0	0	0	0	0	0	0	0	0	0	0
09:15	*	*	*	*	*	*	*	*	*	*	*	*	*	*	*	*
09:30	*	*	*	*	*	*	*	*	*	*	*	*	*	*	*	*
09:45	*	*	*	*	*	*	*	*	*	*	*	*	*	*	*	*
10:00	0	0	0	0	0	0	0	0	0	0	0	0	0	0	0	0
10:15	*	*	*	*	*	*	*	*	*	*	*	*	*	*	*	*
10:30	*	*	*	*	*	*	*	*	*	*	*	*	*	*	*	*
10:45	*	*	*	*	*	*	*	*	*	*	*	*	*	*	*	*
11:00	0	0	0	0	0	0	0	0	0	0	0	0	0	0	0	0
11:15	*	*	*	*	*	*	*	*	*	*	*	*	*	*	*	*
11:30	*	*	*	*	*	*	*	*	*	*	*	*	*	*	*	*
11:45	*	*	*	*	*	*	*	*	*	*	*	*	*	*	*	*
Total	0	39	14	0	2	0	0	0	0	0	0	0	0	1	0	56
Percent	0.0%	69.6%	25.0%	0.0%	3.6%	0.0%	0.0%	0.0%	0.0%	0.0%	0.0%	0.0%	0.0%	1.8%	0.0%	
Grand Total	25	2111	429	12	79	7	1	10	0	2	0	0	0	3	0	2679
Percent	0.9%	78.8%	16.0%	0.4%	2.9%	0.3%	0.0%	0.4%	0.0%	0.1%	0.0%	0.0%	0.0%	0.1%	0.0%	

Tri-State Traffic Data, Inc.

TSTData.com
(610) 466-1460

Rd Name: Rte 211
 Section: 70' S OF CHANDLER LN
 Counter ID: JS88P621

Site Code: NY 211
 Station ID: 000000000000
 41.514745 -74.249629

Latitude: 0' 0.0000 Undefined

Start Time	10-Jun-19		11-Jun-19		12-Jun-19		13-Jun-19		14-Jun-19		15-Jun-19		16-Jun-19	
	Direction 1 North	Direction 2 South	Direction 1 North	Direction 2 South	Direction 1 North	Direction 2 South	Direction 1 North	Direction 2 South	Direction 1 North	Direction 2 South	Direction 1 North	Direction 2 South	Direction 1 North	Direction 2 South
12:00 AM	17	11	*	*	*	*	*	*	*	*	*	*	*	*
01:00	20	5	*	*	*	*	*	*	*	*	*	*	*	*
02:00	11	13	*	*	*	*	*	*	*	*	*	*	*	*
03:00	19	24	*	*	*	*	*	*	*	*	*	*	*	*
04:00	9	52	*	*	*	*	*	*	*	*	*	*	*	*
05:00	25	115	*	*	*	*	*	*	*	*	*	*	*	*
06:00	110	271	*	*	*	*	*	*	*	*	*	*	*	*
07:00	*	*	*	*	*	*	*	*	*	*	*	*	*	*
08:00	*	*	*	*	*	*	*	*	*	*	*	*	*	*
09:00	*	*	*	*	*	*	*	*	*	*	*	*	*	*
10:00	*	*	*	*	*	*	*	*	*	*	*	*	*	*
11:00	*	*	*	*	*	*	*	*	*	*	*	*	*	*
12:00 PM	*	*	*	*	*	*	*	*	*	*	*	*	*	*
01:00	*	*	*	*	*	*	*	*	*	*	*	*	*	*
02:00	*	*	*	*	*	*	*	*	*	*	*	*	*	*
03:00	*	*	*	*	*	*	*	*	*	*	*	*	*	*
04:00	*	*	*	*	*	*	*	*	*	*	*	*	*	*
05:00	*	*	*	*	*	*	*	*	*	*	*	*	*	*
06:00	*	*	*	*	*	*	*	*	*	*	*	*	*	*
07:00	*	*	*	*	*	*	*	*	*	*	*	*	*	*
08:00	*	*	*	*	*	*	*	*	*	*	*	*	*	*
09:00	*	*	*	*	*	*	*	*	*	*	*	*	*	*
10:00	*	*	*	*	*	*	*	*	*	*	*	*	*	*
11:00	*	*	*	*	*	*	*	*	*	*	*	*	*	*
Total	211	491	0	0	0	0	0	0	0	0	0	0	0	0
Day	702													
AM Peak	06:00	06:00	-	-	-	-	-	-	-	-	-	-	-	-
Vol.	110	271	-	-	-	-	-	-	-	-	-	-	-	-
PM Peak	-	-	-	-	-	-	-	-	-	-	-	-	-	-
Vol.	-	-	-	-	-	-	-	-	-	-	-	-	-	-
Comb. Total	702		870		9545		9858		10375		8400		6558	
ADT	ADT 8,946		ADT 8,946		ADT 8,946		ADT 8,946		ADT 8,946		ADT 8,946		ADT 8,946	

Weekday Average	Direction 1 North	Direction 2 South	Direction 1 North	Direction 2 South	Direction 1 North	Direction 2 South	Direction 1 North	Direction 2 South	Direction 1 North	Direction 2 South	Direction 1 North	Direction 2 South
17	20	5	11	11	13	19	9	25	110	271		
211	491	702	06:00	110	271							

Tri-State Traffic Data, Inc
 184 Baker Rd
 Coatesville, PA 19320

Site Code: NY 211
 Station ID: 000000000000
 41.514745 -74.249629

Latitude: 0' 0.0000 Undefined

Direction 1 North

Start Time	0	6	11	16	21	26	31	36	41	46	51	56	61	66	71	Total
Time	5	10	15	20	25	30	35	40	45	50	55	60	65	70	75	
06/04/19	*	*	*	*	*	*	*	*	*	*	*	*	*	*	*	*
01:00	*	*	*	*	*	*	*	*	*	*	*	*	*	*	*	*
02:00	*	*	*	*	*	*	*	*	*	*	*	*	*	*	*	*
03:00	*	*	*	*	*	*	*	*	*	*	*	*	*	*	*	*
04:00	*	*	*	*	*	*	*	*	*	*	*	*	*	*	*	*
05:00	*	*	*	*	*	*	*	*	*	*	*	*	*	*	*	*
06:00	*	*	*	*	*	*	*	*	*	*	*	*	*	*	*	*
07:00	*	*	*	*	*	*	*	*	*	*	*	*	*	*	*	*
08:00	*	*	*	*	*	*	*	*	*	*	*	*	*	*	*	*
09:00	*	*	*	*	*	*	*	*	*	*	*	*	*	*	*	*
10:00	*	*	*	*	*	*	*	*	*	*	*	*	*	*	*	*
11:00	*	*	*	*	*	*	*	*	*	*	*	*	*	*	*	*
12 PM	*	*	*	*	*	*	*	*	*	*	*	*	*	*	*	*
13:00	*	*	*	*	*	*	*	*	*	*	*	*	*	*	*	*
14:00	*	*	*	*	*	*	*	*	*	*	*	*	*	*	*	*
15:00	*	*	*	*	*	*	*	*	*	*	*	*	*	*	*	*
16:00	*	*	*	*	*	*	*	*	*	*	*	*	*	*	*	*
17:00	*	*	*	*	*	*	*	*	*	*	*	*	*	*	*	*
18:00	*	*	*	*	*	*	*	*	*	*	*	*	*	*	*	*
19:00	*	*	*	*	*	*	*	*	*	*	*	*	*	*	*	*
20:00	0	0	0	2	17	46	90	52	13	7	0	0	0	0	0	227
21:00	0	0	0	8	9	28	71	37	5	3	3	0	0	0	0	164
22:00	0	0	0	6	6	6	37	27	15	1	0	1	0	0	0	99
23:00	0	0	0	1	6	7	25	13	8	1	0	0	0	0	0	61
Total	0	0	0	17	38	87	223	129	41	12	3	1	0	0	0	551

Tri-State Traffic Data, Inc

184 Baker Rd
Coatesville, PA 19320

Site Code: NY 211
Station ID: 000000000000
41.514745 -74.249629

Latitude: 0' 0.0000 Undefined

Direction 1 North

Start Time	0	6	11	16	21	26	31	36	41	46	51	56	61	66	71	Total
Time	5	10	15	20	25	30	35	40	45	50	55	60	65	70	75	
06/05/1																
9	0	0	0	1	0	6	16	9	3	2	0	1	0	0	0	38
01:00	0	0	0	2	1	4	6	4	1	0	0	0	0	0	0	18
02:00	0	0	0	0	2	0	9	1	1	0	0	0	0	0	0	13
03:00	0	0	0	0	1	5	4	6	0	0	0	0	0	0	0	16
04:00	0	0	0	0	0	5	11	9	1	0	0	0	0	0	0	26
05:00	0	0	0	0	0	3	17	9	0	2	0	0	0	0	0	31
06:00	0	0	0	0	0	12	54	15	9	2	1	0	0	0	0	93
07:00	0	0	0	4	4	19	75	54	14	6	1	0	0	0	0	177
08:00	0	0	1	7	18	23	60	72	9	7	1	1	0	0	0	199
09:00	0	0	1	3	15	30	92	40	22	2	0	1	0	0	0	206
10:00	0	0	0	3	19	24	89	58	11	2	5	0	0	0	0	211
11:00	0	0	0	7	14	36	99	53	28	1	3	0	0	0	0	241
12 PM	0	0	5	13	27	44	95	65	28	8	1	0	1	0	0	287
13:00	0	1	0	15	41	65	90	58	15	7	0	0	0	0	0	292
14:00	0	0	2	12	38	87	157	49	7	0	0	0	0	0	0	352
15:00	0	0	5	12	62	78	153	99	28	7	3	0	0	0	0	447
16:00	0	0	3	16	41	71	198	139	34	3	0	0	0	0	0	505
17:00	0	0	1	14	41	73	218	138	41	5	3	0	0	0	0	534
18:00	0	0	2	3	19	47	130	97	41	12	1	0	0	0	0	352
19:00	0	0	2	7	26	40	126	82	24	8	2	0	0	0	0	317
20:00	0	0	0	1	18	31	109	51	16	5	0	0	0	0	0	231
21:00	0	0	0	2	15	23	52	36	12	1	1	0	0	0	0	142
22:00	0	0	0	6	11	10	35	20	4	2	1	0	0	0	0	89
23:00	0	0	0	1	7	12	23	20	6	1	0	0	0	0	0	70
Total	0	1	22	129	420	748	1918	1184	355	83	23	3	1	0	0	4887

Tri-State Traffic Data, Inc

184 Baker Rd
Coatesville, PA 19320

Site Code: NY 211
Station ID: 000000000000
41.514745 -74.249629

Latitude: 0' 0.0000 Undefined

Direction 1 North

Start Time	0	6	11	16	21	26	31	36	41	46	51	56	61	66	71	Total
Time	5	10	15	20	25	30	35	40	45	50	55	60	65	70	75	
06/06/1																
9	0	0	0	0	5	2	12	6	2	1	1	0	0	0	0	29
01:00	0	0	0	0	1	3	8	0	2	1	0	0	0	0	0	15
02:00	0	0	0	0	0	5	5	2	1	0	0	0	0	0	0	13
03:00	0	0	0	0	1	5	6	2	1	1	0	0	0	0	0	16
04:00	0	0	0	0	0	3	11	5	1	0	0	1	0	0	0	21
05:00	0	0	0	0	3	5	13	9	5	0	0	2	0	0	0	37
06:00	0	0	0	0	3	12	40	31	22	2	1	0	0	0	0	111
07:00	0	0	0	5	6	22	63	58	23	11	0	0	0	0	0	188
08:00	0	0	0	6	10	17	73	73	29	6	1	0	0	0	0	215
09:00	0	0	0	1	12	21	91	77	14	5	0	0	0	0	0	221
10:00	0	0	4	13	19	39	88	50	9	7	3	0	0	0	0	232
11:00	0	0	1	15	27	34	78	76	33	4	0	0	0	0	0	268
12 PM	0	0	0	11	19	38	142	94	23	9	2	0	0	0	0	338
13:00	0	0	0	7	22	40	108	91	22	7	2	0	0	0	0	299
14:00	0	0	4	13	27	73	201	55	12	6	0	0	0	0	0	391
15:00	0	0	1	8	51	68	186	113	22	10	3	0	0	0	0	462
16:00	0	0	2	14	47	58	209	142	35	9	3	0	0	0	0	519
17:00	0	0	0	18	60	91	193	125	42	5	1	0	1	0	0	536
18:00	0	0	0	11	24	47	139	94	32	7	1	0	0	0	0	355
19:00	0	0	0	1	14	31	117	84	25	5	0	0	0	0	0	277
20:00	0	0	0	9	11	34	107	48	10	8	0	0	0	0	0	227
21:00	0	0	0	3	11	21	83	43	14	4	0	0	0	0	0	179
22:00	0	0	0	2	7	12	28	21	10	3	0	1	0	0	0	84
23:00	0	0	0	2	7	16	31	13	9	0	0	0	0	0	0	78
Total	0	0	12	139	387	697	2032	1312	398	111	18	4	1	0	0	5111

Tri-State Traffic Data, Inc

184 Baker Rd
Coatesville, PA 19320

Site Code: NY 211
Station ID: 000000000000
41.514745 -74.249629

Latitude: 0' 0.0000 Undefined

Direction 1 North

Start Time	0	6	11	16	21	26	31	36	41	46	51	56	61	66	71	Total
Time	5	10	15	20	25	30	35	40	45	50	55	60	65	70	75	
06/07/1																
9	0	0	0	0	3	4	16	5	3	2	1	0	0	0	0	34
01:00	0	0	0	3	0	4	9	3	3	1	0	0	0	0	0	23
02:00	0	0	0	0	1	2	7	4	0	0	0	0	0	0	0	14
03:00	0	0	0	1	0	4	5	6	2	0	0	0	0	0	0	18
04:00	0	0	0	0	0	4	6	3	2	0	0	0	0	0	0	15
05:00	0	0	0	0	0	2	8	14	6	0	1	0	0	0	0	31
06:00	0	0	0	0	3	8	46	26	13	2	0	0	0	0	0	98
07:00	0	0	0	5	16	26	49	52	21	6	5	0	0	0	0	180
08:00	0	3	2	6	6	31	72	54	22	6	1	0	0	0	0	203
09:00	0	0	0	4	18	19	72	69	18	3	2	2	0	0	0	207
10:00	0	0	3	8	11	23	79	73	20	10	3	1	0	0	0	231
11:00	0	0	0	2	16	44	90	86	27	13	1	1	0	0	0	280
12 PM	0	0	1	8	31	34	152	90	45	12	1	0	0	0	0	374
13:00	0	0	1	8	20	47	127	113	43	12	0	0	0	0	0	371
14:00	0	2	7	20	34	40	176	120	21	8	2	0	0	0	0	430
15:00	0	0	0	22	46	59	180	120	25	6	3	0	0	0	0	461
16:00	0	0	2	12	62	56	158	158	40	4	2	0	0	0	0	494
17:00	0	0	2	11	47	61	176	143	48	11	4	0	0	0	0	503
18:00	0	0	2	11	41	67	133	111	26	9	2	0	0	0	0	402
19:00	0	0	0	11	16	28	117	84	42	11	3	0	1	0	0	313
20:00	0	0	0	4	18	40	87	59	25	5	2	0	0	0	0	240
21:00	0	0	0	6	18	31	86	41	13	4	0	0	0	0	0	199
22:00	0	0	0	3	11	19	62	37	13	5	2	0	0	0	0	152
23:00	0	0	0	4	4	17	41	44	17	4	3	0	1	0	0	135
Total	0	5	20	149	422	670	1954	1515	495	134	38	4	2	0	0	5408

Tri-State Traffic Data, Inc

184 Baker Rd
Coatesville, PA 19320

Site Code: NY 211
Station ID: 000000000000
41.514745 -74.249629

Latitude: 0' 0.0000 Undefined

Direction 1 North

Start Time	0	6	11	16	21	26	31	36	41	46	51	56	61	66	71	Total
Time	5	10	15	20	25	30	35	40	45	50	55	60	65	70	75	
06/08/1																
9	0	0	0	2	6	8	23	15	4	3	0	0	0	0	0	61
01:00	0	0	0	0	2	7	17	9	3	1	1	0	0	0	0	40
02:00	0	0	0	0	1	2	9	5	1	1	0	0	0	0	0	19
03:00	0	0	0	0	0	1	2	6	3	0	0	0	0	0	0	12
04:00	0	0	0	0	0	1	6	2	1	1	0	0	0	0	0	11
05:00	0	0	0	0	1	1	4	11	2	1	0	0	0	0	0	20
06:00	0	0	0	0	1	5	12	12	8	0	1	2	0	0	0	41
07:00	0	0	0	0	5	7	38	28	15	3	3	1	0	0	0	100
08:00	0	0	1	1	9	17	46	55	15	2	1	0	0	0	0	147
09:00	0	0	0	2	7	10	64	89	30	6	3	1	0	0	0	212
10:00	0	0	0	5	22	19	74	106	28	10	3	0	0	0	0	267
11:00	0	0	0	3	24	40	93	89	53	17	2	1	1	0	0	323
12 PM	0	0	1	7	31	36	131	106	34	17	5	1	0	0	0	369
13:00	0	0	1	5	30	24	110	111	57	12	6	0	0	0	0	356
14:00	0	0	1	10	34	24	104	121	43	5	0	0	0	0	0	342
15:00	0	0	1	3	22	31	109	85	42	13	2	0	0	0	0	308
16:00	0	0	0	7	27	39	126	107	33	8	4	0	0	0	0	351
17:00	0	0	0	1	14	26	96	91	29	13	3	0	0	0	0	273
18:00	0	0	0	16	24	16	85	87	42	9	6	0	0	0	0	285
19:00	0	0	0	2	17	37	93	72	22	15	3	0	0	0	0	261
20:00	0	0	0	8	10	18	67	59	18	5	3	0	0	0	0	188
21:00	0	0	0	7	10	24	64	39	12	7	1	0	0	0	0	164
22:00	0	0	0	5	8	14	65	39	13	1	0	2	0	0	0	147
23:00	0	0	0	1	8	14	29	26	6	2	0	0	0	0	0	86
Total	0	0	5	85	313	421	1467	1370	514	152	47	8	1	0	0	4383

Tri-State Traffic Data, Inc
 184 Baker Rd
 Coatesville, PA 19320

Site Code: NY 211
 Station ID: 000000000000
 41.514745 -74.249629

Latitude: 0' 0.0000 Undefined

Direction 1 North

Start Time	0	6	11	16	21	26	31	36	41	46	51	56	61	66	71	Total
Time	5	10	15	20	25	30	35	40	45	50	55	60	65	70	75	
06/09/1																
9	0	0	0	1	4	5	22	14	2	1	0	0	0	0	0	49
01:00	0	0	0	0	2	4	16	10	2	1	0	0	0	0	0	35
02:00	0	0	0	0	1	1	5	2	0	0	0	0	0	0	0	9
03:00	0	0	0	0	0	1	3	1	1	2	0	0	0	0	0	8
04:00	0	0	0	1	0	1	2	3	2	0	0	0	0	0	0	9
05:00	0	0	0	2	1	0	5	5	0	0	0	0	0	0	0	13
06:00	0	0	0	0	0	3	7	7	4	1	1	1	0	0	0	24
07:00	0	0	0	2	1	6	16	10	8	3	1	1	0	0	0	48
08:00	0	2	0	0	9	4	21	22	8	3	3	1	0	0	0	73
09:00	0	0	0	2	15	13	34	39	15	9	3	0	0	0	0	130
10:00	0	1	0	1	9	14	60	49	21	18	2	0	0	0	0	175
11:00	0	0	0	2	18	18	94	86	38	6	4	0	0	0	0	266
12 PM	0	0	0	6	33	26	107	85	32	7	2	0	0	0	0	298
13:00	0	0	0	4	34	33	124	83	30	7	0	1	0	0	0	316
14:00	0	0	0	10	29	53	83	80	34	10	4	1	0	0	0	304
15:00	0	0	0	8	30	34	107	101	36	14	3	0	0	0	0	333
16:00	0	0	0	11	35	30	96	79	36	12	0	0	0	0	0	299
17:00	0	0	0	5	20	25	73	87	32	13	0	1	0	0	0	256
18:00	0	0	0	3	19	18	75	75	21	10	0	2	0	0	0	223
19:00	0	0	0	4	20	24	53	51	15	4	2	1	0	0	0	174
20:00	0	0	0	6	15	26	56	40	8	6	0	0	0	0	0	157
21:00	0	0	2	2	7	15	33	23	10	3	0	0	0	0	0	95
22:00	0	0	0	0	3	11	21	15	6	0	2	1	0	0	0	59
23:00	0	0	0	0	5	3	10	6	6	1	0	0	0	0	0	31
Total	0	3	2	70	310	368	1123	973	367	131	27	10	0	0	0	3384

Tri-State Traffic Data, Inc
 184 Baker Rd
 Coatesville, PA 19320

Site Code: NY 211
 Station ID: 000000000000
 41.514745 -74.249629

Latitude: 0' 0.0000 Undefined

Direction 1 North

Start Time	0	6	11	16	21	26	31	36	41	46	51	56	61	66	71	Total
Time	5	10	15	20	25	30	35	40	45	50	55	60	65	70	75	
06/10/1																
9	0	0	0	1	1	1	6	7	1	0	0	0	0	0	0	17
01:00	0	0	0	0	2	2	6	6	3	0	1	0	0	0	0	20
02:00	0	0	0	0	2	1	7	1	0	0	0	0	0	0	0	11
03:00	0	0	0	0	1	2	9	5	2	0	0	0	0	0	0	19
04:00	0	0	0	0	0	3	4	2	0	0	0	0	0	0	0	9
05:00	0	0	0	0	0	0	10	8	5	2	0	0	0	0	0	25
06:00	0	0	0	1	11	28	40	20	7	1	2	0	0	0	0	110
07:00	*	*	*	*	*	*	*	*	*	*	*	*	*	*	*	*
08:00	*	*	*	*	*	*	*	*	*	*	*	*	*	*	*	*
09:00	*	*	*	*	*	*	*	*	*	*	*	*	*	*	*	*
10:00	*	*	*	*	*	*	*	*	*	*	*	*	*	*	*	*
11:00	*	*	*	*	*	*	*	*	*	*	*	*	*	*	*	*
12 PM	*	*	*	*	*	*	*	*	*	*	*	*	*	*	*	*
13:00	*	*	*	*	*	*	*	*	*	*	*	*	*	*	*	*
14:00	*	*	*	*	*	*	*	*	*	*	*	*	*	*	*	*
15:00	*	*	*	*	*	*	*	*	*	*	*	*	*	*	*	*
16:00	*	*	*	*	*	*	*	*	*	*	*	*	*	*	*	*
17:00	*	*	*	*	*	*	*	*	*	*	*	*	*	*	*	*
18:00	*	*	*	*	*	*	*	*	*	*	*	*	*	*	*	*
19:00	*	*	*	*	*	*	*	*	*	*	*	*	*	*	*	*
20:00	*	*	*	*	*	*	*	*	*	*	*	*	*	*	*	*
21:00	*	*	*	*	*	*	*	*	*	*	*	*	*	*	*	*
22:00	*	*	*	*	*	*	*	*	*	*	*	*	*	*	*	*
23:00	*	*	*	*	*	*	*	*	*	*	*	*	*	*	*	*
Total	0	0	0	2	17	37	82	49	18	3	3	0	0	0	0	211
Grand Total	0	9	61	591	1907	3028	8799	6532	2188	626	159	30	5	0	0	23935

Stats

15th Percentile : 26 MPH
 50th Percentile : 33 MPH
 85th Percentile : 39 MPH
 95th Percentile : 44 MPH

Mean Speed(Average) : 34 MPH
 10 MPH Pace Speed : 31-40 MPH
 Number in Pace : 15331
 Percent in Pace : 64.1%
 Number of Vehicles > 55 MPH : 35
 Percent of Vehicles > 55 MPH : 0.1%

Tri-State Traffic Data, Inc
 184 Baker Rd
 Coatesville, PA 19320

Site Code: NY 211
 Station ID: 000000000000
 41.514745 -74.249629

Latitude: 0' 0.0000 Undefined

Direction 2 South

Start Time	0	6	11	16	21	26	31	36	41	46	51	56	61	66	71	Total
Time	5	10	15	20	25	30	35	40	45	50	55	60	65	70	75	
06/04/19	*	*	*	*	*	*	*	*	*	*	*	*	*	*	*	*
01:00	*	*	*	*	*	*	*	*	*	*	*	*	*	*	*	*
02:00	*	*	*	*	*	*	*	*	*	*	*	*	*	*	*	*
03:00	*	*	*	*	*	*	*	*	*	*	*	*	*	*	*	*
04:00	*	*	*	*	*	*	*	*	*	*	*	*	*	*	*	*
05:00	*	*	*	*	*	*	*	*	*	*	*	*	*	*	*	*
06:00	*	*	*	*	*	*	*	*	*	*	*	*	*	*	*	*
07:00	*	*	*	*	*	*	*	*	*	*	*	*	*	*	*	*
08:00	*	*	*	*	*	*	*	*	*	*	*	*	*	*	*	*
09:00	*	*	*	*	*	*	*	*	*	*	*	*	*	*	*	*
10:00	*	*	*	*	*	*	*	*	*	*	*	*	*	*	*	*
11:00	*	*	*	*	*	*	*	*	*	*	*	*	*	*	*	*
12 PM	*	*	*	*	*	*	*	*	*	*	*	*	*	*	*	*
13:00	*	*	*	*	*	*	*	*	*	*	*	*	*	*	*	*
14:00	*	*	*	*	*	*	*	*	*	*	*	*	*	*	*	*
15:00	*	*	*	*	*	*	*	*	*	*	*	*	*	*	*	*
16:00	*	*	*	*	*	*	*	*	*	*	*	*	*	*	*	*
17:00	*	*	*	*	*	*	*	*	*	*	*	*	*	*	*	*
18:00	*	*	*	*	*	*	*	*	*	*	*	*	*	*	*	*
19:00	*	*	*	*	*	*	*	*	*	*	*	*	*	*	*	*
20:00	0	0	0	3	6	6	29	63	47	7	1	1	1	0	0	164
21:00	0	0	0	2	5	1	13	27	25	7	0	0	0	0	0	80
22:00	0	0	0	0	1	6	7	17	9	2	0	3	0	0	0	45
23:00	0	0	0	1	1	0	8	13	7	0	0	0	0	0	0	30
Total	0	0	0	6	13	13	57	120	88	16	1	4	1	0	0	319

Tri-State Traffic Data, Inc

184 Baker Rd
Coatesville, PA 19320

Site Code: NY 211
Station ID: 000000000000
41.514745 -74.249629

Latitude: 0' 0.0000 Undefined

Direction 2 South

Start Time	0	6	11	16	21	26	31	36	41	46	51	56	61	66	71	Total
Time	5	10	15	20	25	30	35	40	45	50	55	60	65	70	75	
06/05/1																
9	0	0	1	0	0	0	3	8	7	1	0	0	0	0	0	20
01:00	0	0	0	0	0	0	1	3	1	1	0	0	0	0	0	6
02:00	0	0	0	0	2	0	5	8	1	0	0	0	0	0	0	16
03:00	0	0	0	0	1	0	6	13	4	3	1	0	0	0	0	28
04:00	0	0	0	1	3	1	14	24	10	3	0	0	0	0	0	56
05:00	0	0	0	3	7	4	26	45	12	5	0	0	0	0	0	102
06:00	0	0	0	7	12	4	51	88	89	20	2	0	0	0	0	273
07:00	0	0	2	8	25	20	69	202	130	21	1	0	0	0	0	478
08:00	0	0	1	7	23	10	70	207	110	22	4	1	0	0	0	455
09:00	0	0	1	4	19	4	36	124	68	21	7	0	0	0	0	284
10:00	0	0	0	3	15	11	36	97	56	14	5	1	0	0	0	238
11:00	0	0	0	4	22	5	39	110	66	19	3	0	0	0	0	268
12 PM	0	0	1	1	18	10	40	121	90	16	4	0	0	0	0	301
13:00	0	2	0	4	21	28	59	95	54	16	3	0	0	0	0	282
14:00	0	0	0	5	25	43	64	90	56	15	1	0	0	0	0	299
15:00	0	0	0	7	31	8	59	105	62	31	3	1	0	0	0	307
16:00	0	1	0	8	26	20	49	103	69	20	1	0	0	0	0	297
17:00	0	0	0	3	10	10	31	103	80	22	1	0	0	0	0	260
18:00	0	0	0	5	11	9	31	71	81	29	3	0	0	0	0	240
19:00	0	0	0	4	10	2	20	54	42	10	3	0	0	0	0	145
20:00	0	0	0	2	4	8	33	58	29	7	3	0	0	0	0	144
21:00	0	0	0	0	5	1	18	23	16	3	0	1	0	0	0	67
22:00	0	0	0	2	4	2	16	13	10	5	1	1	1	0	0	55
23:00	0	0	0	1	1	0	6	17	10	1	0	0	0	0	0	36
Total	0	3	6	79	295	200	782	1782	1153	305	46	5	1	0	0	4657

Tri-State Traffic Data, Inc

184 Baker Rd
Coatesville, PA 19320

Site Code: NY 211
Station ID: 000000000000
41.514745 -74.249629

Latitude: 0' 0.0000 Undefined

Direction 2 South

Start Time	0	6	11	16	21	26	31	36	41	46	51	56	61	66	71	Total
Time	5	10	15	20	25	30	35	40	45	50	55	60	65	70	75	
06/06/1																
9	0	0	0	0	0	0	2	4	6	2	2	0	0	0	0	16
01:00	0	0	0	0	0	0	2	2	2	0	0	0	0	0	0	6
02:00	0	0	0	0	1	1	4	3	2	0	0	0	0	0	0	11
03:00	0	0	0	0	0	0	7	9	5	3	2	0	0	0	0	26
04:00	0	0	0	2	1	2	13	18	11	4	0	0	0	0	0	51
05:00	0	1	0	1	7	1	20	46	21	10	2	0	0	0	0	109
06:00	0	0	0	8	12	8	44	97	78	21	6	0	0	1	0	275
07:00	0	0	0	3	23	9	72	178	113	31	3	0	0	0	0	432
08:00	0	0	0	6	21	9	41	160	148	32	4	0	0	0	0	421
09:00	0	0	0	6	17	4	49	108	112	32	2	0	0	0	0	330
10:00	0	0	0	6	26	3	45	113	59	15	4	0	0	0	0	271
11:00	0	0	0	6	25	16	62	118	72	14	1	0	0	0	0	314
12 PM	0	0	0	3	16	9	34	100	91	27	5	0	0	0	0	285
13:00	0	0	1	5	16	16	67	89	53	21	7	0	0	0	0	275
14:00	0	0	0	3	18	26	72	91	66	13	4	0	0	0	0	293
15:00	0	0	0	3	36	18	66	116	75	22	4	0	0	0	0	340
16:00	0	0	0	3	27	9	35	104	91	24	6	1	0	0	0	300
17:00	0	0	4	6	19	16	47	107	65	27	2	0	0	0	0	293
18:00	0	0	0	13	15	10	37	71	73	20	5	0	0	0	0	244
19:00	0	0	0	6	12	5	20	61	48	17	0	0	0	0	0	169
20:00	0	0	0	4	10	4	26	39	31	9	7	0	0	0	0	130
21:00	0	0	0	2	8	0	15	23	18	9	3	0	0	0	0	78
22:00	0	0	0	0	3	2	10	16	9	4	0	1	0	0	0	45
23:00	0	0	0	0	1	0	6	13	5	4	0	0	1	0	0	30
Total	0	1	5	86	314	168	796	1686	1254	361	69	2	1	1	0	4744

Tri-State Traffic Data, Inc

184 Baker Rd
Coatesville, PA 19320

Site Code: NY 211
Station ID: 000000000000
41.514745 -74.249629

Latitude: 0' 0.0000 Undefined

Direction 2 South

Start Time	0	6	11	16	21	26	31	36	41	46	51	56	61	66	71	Total
Time	5	10	15	20	25	30	35	40	45	50	55	60	65	70	75	
06/07/1																
9	0	0	0	0	0	0	3	6	4	3	0	1	0	1	0	18
01:00	0	0	0	0	0	0	1	5	0	1	0	0	0	0	0	7
02:00	0	0	0	0	1	1	4	2	1	1	0	0	0	0	0	10
03:00	0	0	0	0	0	1	5	13	9	2	1	0	0	0	0	31
04:00	0	0	0	0	2	3	9	17	13	2	1	0	0	0	0	47
05:00	0	0	0	3	7	6	14	45	23	7	2	0	0	0	0	107
06:00	0	0	0	6	9	5	47	75	101	23	3	1	0	0	0	270
07:00	0	0	0	4	20	9	57	153	111	28	1	0	0	0	0	383
08:00	0	1	0	6	29	13	46	192	119	35	4	0	0	0	0	445
09:00	0	0	0	4	22	12	30	134	109	29	3	0	0	0	0	343
10:00	0	0	1	7	20	4	37	111	68	23	8	1	0	0	0	280
11:00	0	0	1	7	16	9	48	95	51	9	3	1	0	0	0	240
12 PM	0	0	2	4	13	11	47	118	90	36	1	0	0	0	0	322
13:00	0	0	1	6	16	13	39	90	79	30	1	0	0	0	0	275
14:00	0	0	2	8	27	33	49	120	73	12	5	0	0	0	0	329
15:00	0	0	0	7	29	27	63	104	92	34	5	0	0	0	0	361
16:00	0	0	0	6	29	13	53	116	77	26	2	1	0	0	0	323
17:00	0	0	0	4	17	13	46	121	79	19	4	0	0	0	0	303
18:00	0	0	0	4	24	6	38	116	63	23	2	0	0	1	1	278
19:00	0	0	0	10	13	5	24	73	51	21	3	0	0	0	0	200
20:00	0	0	0	5	12	9	29	38	34	8	2	0	0	0	0	137
21:00	0	0	0	1	4	3	27	35	26	8	2	0	0	0	0	106
22:00	0	0	0	2	4	1	17	41	30	7	2	0	0	0	0	104
23:00	0	0	0	1	1	2	7	21	7	3	1	1	0	0	0	44
Total	0	1	7	95	315	199	740	1841	1310	390	56	6	0	2	1	4963

Tri-State Traffic Data, Inc

184 Baker Rd
Coatesville, PA 19320

Site Code: NY 211
Station ID: 000000000000
41.514745 -74.249629

Latitude: 0' 0.0000 Undefined

Direction 2 South

Start Time	0	6	11	16	21	26	31	36	41	46	51	56	61	66	71	Total
Time	5	10	15	20	25	30	35	40	45	50	55	60	65	70	75	
06/08/1																
9	0	0	0	2	0	1	7	7	9	1	0	1	0	0	0	28
01:00	0	0	0	1	0	0	2	2	6	2	1	0	1	0	0	15
02:00	0	0	0	1	1	0	1	3	5	2	0	0	0	0	0	13
03:00	0	0	0	0	0	0	4	3	4	2	3	0	0	0	0	16
04:00	0	0	0	0	1	0	4	6	6	1	0	0	0	0	0	18
05:00	0	0	0	1	0	0	6	16	6	6	0	1	0	0	0	36
06:00	0	0	0	0	0	0	13	33	38	14	1	1	0	0	0	100
07:00	0	0	0	2	12	1	15	60	60	19	5	1	0	0	0	175
08:00	0	0	0	4	18	5	36	93	63	28	8	1	0	0	0	256
09:00	0	0	0	1	16	5	36	125	90	36	7	0	0	0	0	316
10:00	0	1	0	4	25	16	35	102	110	30	6	1	0	0	0	330
11:00	0	0	0	10	26	8	30	102	94	47	4	0	2	0	0	323
12 PM	0	0	0	1	19	13	50	108	119	41	5	0	0	0	0	356
13:00	0	0	0	3	25	16	42	93	85	23	4	5	2	0	0	298
14:00	0	0	0	4	21	5	21	85	90	35	6	1	0	0	0	268
15:00	0	0	0	3	17	4	27	83	83	33	5	0	0	0	0	255
16:00	0	0	0	4	20	11	31	83	79	38	8	2	0	0	0	276
17:00	0	0	0	4	16	4	23	71	77	31	8	1	0	0	0	235
18:00	0	0	0	4	12	3	16	49	83	23	6	1	0	0	0	197
19:00	0	0	1	2	11	2	28	46	49	22	6	2	0	1	0	170
20:00	0	0	0	2	4	4	21	42	38	9	4	0	0	0	0	124
21:00	0	0	0	0	2	1	11	42	32	7	0	0	0	0	0	95
22:00	0	0	0	3	5	4	12	31	12	2	1	0	0	0	0	70
23:00	0	0	0	1	2	0	8	16	16	2	2	0	0	0	0	47
Total	0	1	1	57	253	103	479	1301	1254	454	90	18	5	1	0	4017

Tri-State Traffic Data, Inc

184 Baker Rd
Coatesville, PA 19320

Site Code: NY 211
Station ID: 000000000000
41.514745 -74.249629

Latitude: 0' 0.0000 Undefined

Direction 2 South

Start Time	0	6	11	16	21	26	31	36	41	46	51	56	61	66	71	Total
Time	5	10	15	20	25	30	35	40	45	50	55	60	65	70	75	
06/09/1																
9	0	0	0	0	1	0	3	10	6	0	1	0	0	0	0	21
01:00	0	0	0	0	0	3	1	8	5	1	0	0	0	0	0	18
02:00	0	0	0	0	0	0	0	1	4	0	0	0	0	0	0	5
03:00	0	0	0	0	0	0	0	0	3	1	0	0	0	0	0	4
04:00	0	0	0	1	0	0	2	1	3	0	1	0	0	0	0	8
05:00	0	0	0	1	0	1	3	3	10	5	2	1	0	0	0	26
06:00	0	0	0	0	1	3	9	24	15	8	4	4	0	0	0	68
07:00	0	0	1	0	5	3	3	24	32	12	7	1	0	0	0	88
08:00	0	0	0	5	13	2	20	38	41	17	5	0	0	0	0	141
09:00	0	0	1	5	13	5	23	60	65	25	4	0	0	0	0	201
10:00	0	0	1	6	16	12	21	80	77	26	3	0	0	0	0	242
11:00	0	0	1	4	16	9	30	85	89	32	7	2	0	0	0	275
12 PM	0	0	0	5	15	7	30	104	93	35	9	1	0	0	0	299
13:00	0	0	0	4	12	9	39	119	95	28	5	1	1	0	0	313
14:00	0	1	0	1	12	14	26	101	89	21	6	2	0	0	0	273
15:00	0	1	0	5	15	6	36	86	73	21	1	0	1	0	0	245
16:00	0	0	0	4	16	8	25	64	61	28	10	1	0	0	0	217
17:00	0	0	0	5	19	10	23	51	62	24	7	1	1	0	0	203
18:00	0	0	1	4	10	5	16	56	46	18	4	1	0	0	0	161
19:00	0	0	1	5	11	10	30	32	28	8	2	0	0	0	0	127
20:00	0	0	0	1	11	6	21	32	21	12	1	2	0	0	0	107
21:00	0	0	0	3	3	2	11	16	17	4	3	1	0	0	0	60
22:00	0	0	1	1	3	2	8	15	13	1	0	0	0	0	0	44
23:00	0	0	0	0	1	2	8	9	3	5	0	0	0	0	0	28
Total	0	2	7	60	193	119	388	1019	951	332	82	18	3	0	0	3174

Tri-State Traffic Data, Inc
 184 Baker Rd
 Coatesville, PA 19320

Site Code: NY 211
 Station ID: 000000000000
 41.514745 -74.249629

Latitude: 0' 0.0000 Undefined

Direction 2 South

Start Time	0	6	11	16	21	26	31	36	41	46	51	56	61	66	71	Total
Time	5	10	15	20	25	30	35	40	45	50	55	60	65	70	75	
06/10/1																
9	0	0	0	0	0	0	1	4	4	1	1	0	0	0	0	11
01:00	0	0	0	0	0	0	1	1	3	0	0	0	0	0	0	5
02:00	0	0	0	0	1	0	6	2	3	1	0	0	0	0	0	13
03:00	0	0	0	0	1	0	4	10	8	1	0	0	0	0	0	24
04:00	0	0	0	2	3	2	12	18	11	1	3	0	0	0	0	52
05:00	0	0	0	4	5	4	22	51	15	12	2	0	0	0	0	115
06:00	0	0	0	7	11	17	77	96	55	8	0	0	0	0	0	271
07:00	*	*	*	*	*	*	*	*	*	*	*	*	*	*	*	*
08:00	*	*	*	*	*	*	*	*	*	*	*	*	*	*	*	*
09:00	*	*	*	*	*	*	*	*	*	*	*	*	*	*	*	*
10:00	*	*	*	*	*	*	*	*	*	*	*	*	*	*	*	*
11:00	*	*	*	*	*	*	*	*	*	*	*	*	*	*	*	*
12 PM	*	*	*	*	*	*	*	*	*	*	*	*	*	*	*	*
13:00	*	*	*	*	*	*	*	*	*	*	*	*	*	*	*	*
14:00	*	*	*	*	*	*	*	*	*	*	*	*	*	*	*	*
15:00	*	*	*	*	*	*	*	*	*	*	*	*	*	*	*	*
16:00	*	*	*	*	*	*	*	*	*	*	*	*	*	*	*	*
17:00	*	*	*	*	*	*	*	*	*	*	*	*	*	*	*	*
18:00	*	*	*	*	*	*	*	*	*	*	*	*	*	*	*	*
19:00	*	*	*	*	*	*	*	*	*	*	*	*	*	*	*	*
20:00	*	*	*	*	*	*	*	*	*	*	*	*	*	*	*	*
21:00	*	*	*	*	*	*	*	*	*	*	*	*	*	*	*	*
22:00	*	*	*	*	*	*	*	*	*	*	*	*	*	*	*	*
23:00	*	*	*	*	*	*	*	*	*	*	*	*	*	*	*	*
Total	0	0	0	13	21	23	123	182	99	24	6	0	0	0	0	491
Grand Total	0	8	26	396	1404	825	3365	7931	6109	1882	350	53	11	4	1	22365

Stats

15th Percentile : 31 MPH
 50th Percentile : 38 MPH
 85th Percentile : 44 MPH
 95th Percentile : 48 MPH

Mean Speed(Average) : 38 MPH
 10 MPH Pace Speed : 36-45 MPH
 Number in Pace : 1404
 Percent in Pace : 62.8%
 Number of Vehicles > 55 MPH : 69
 Percent of Vehicles > 55 MPH : 0.3%

Tri-State Traffic Data, Inc
 184 Baker Rd
 Coatesville, PA 19320

Site Code: NY 211
 Station ID: 00000000000
 41.514745 -74.249629

Latitude: 0' 0.0000 Undefined

Direction 1 North

Start Time	Class 1	Class 2	Class 3	Class 4	Class 5	Class 6	Class 7	Class 8	Class 9	Class 10	Class 11	Class 12	Class 13	Class 14	Class 15	Total
12 PM	*	*	*	*	*	*	*	*	*	*	*	*	*	*	*	*
12:15	*	*	*	*	*	*	*	*	*	*	*	*	*	*	*	*
12:30	*	*	*	*	*	*	*	*	*	*	*	*	*	*	*	*
12:45	*	*	*	*	*	*	*	*	*	*	*	*	*	*	*	*
13:00	0	0	0	0	0	0	0	0	0	0	0	0	0	0	0	0
13:15	*	*	*	*	*	*	*	*	*	*	*	*	*	*	*	*
13:30	*	*	*	*	*	*	*	*	*	*	*	*	*	*	*	*
13:45	*	*	*	*	*	*	*	*	*	*	*	*	*	*	*	*
14:00	0	0	0	0	0	0	0	0	0	0	0	0	0	0	0	0
14:15	*	*	*	*	*	*	*	*	*	*	*	*	*	*	*	*
14:30	*	*	*	*	*	*	*	*	*	*	*	*	*	*	*	*
14:45	*	*	*	*	*	*	*	*	*	*	*	*	*	*	*	*
15:00	0	0	0	0	0	0	0	0	0	0	0	0	0	0	0	0
15:15	*	*	*	*	*	*	*	*	*	*	*	*	*	*	*	*
15:30	*	*	*	*	*	*	*	*	*	*	*	*	*	*	*	*
15:45	*	*	*	*	*	*	*	*	*	*	*	*	*	*	*	*
16:00	0	0	0	0	0	0	0	0	0	0	0	0	0	0	0	0
16:15	*	*	*	*	*	*	*	*	*	*	*	*	*	*	*	*
16:30	*	*	*	*	*	*	*	*	*	*	*	*	*	*	*	*
16:45	*	*	*	*	*	*	*	*	*	*	*	*	*	*	*	*
17:00	0	0	0	0	0	0	0	0	0	0	0	0	0	0	0	0
17:15	*	*	*	*	*	*	*	*	*	*	*	*	*	*	*	*
17:30	*	*	*	*	*	*	*	*	*	*	*	*	*	*	*	*
17:45	*	*	*	*	*	*	*	*	*	*	*	*	*	*	*	*
18:00	0	0	0	0	0	0	0	0	0	0	0	0	0	0	0	0
18:15	*	*	*	*	*	*	*	*	*	*	*	*	*	*	*	*
18:30	*	*	*	*	*	*	*	*	*	*	*	*	*	*	*	*
18:45	*	*	*	*	*	*	*	*	*	*	*	*	*	*	*	*
19:00	0	0	0	0	0	0	0	0	0	0	0	0	0	0	0	0
19:15	*	*	*	*	*	*	*	*	*	*	*	*	*	*	*	*
19:30	*	*	*	*	*	*	*	*	*	*	*	*	*	*	*	*
19:45	*	*	*	*	*	*	*	*	*	*	*	*	*	*	*	*
20:00	0	0	0	0	0	0	0	0	0	0	0	0	0	0	0	0
20:15	0	59	6	0	3	2	0	0	0	0	0	0	0	0	0	70
20:30	0	51	6	0	1	1	0	0	0	0	0	0	0	0	0	59
20:45	0	38	9	0	0	2	0	0	0	0	0	0	0	0	0	49
21:00	0	40	7	0	0	1	0	1	0	0	0	0	0	0	0	49
21:15	0	188	28	0	4	6	0	1	0	0	0	0	0	0	0	227
21:30	0	47	8	0	1	0	0	0	0	0	0	0	0	2	0	58
21:45	0	42	1	1	1	1	0	0	1	0	0	0	0	0	0	47
22:00	0	27	3	0	0	2	0	0	0	0	0	0	0	0	0	32
22:15	0	20	4	0	1	1	0	0	0	0	0	0	0	1	0	27
22:30	0	136	16	1	3	4	0	0	1	0	0	0	0	3	0	164
22:45	0	25	4	0	0	2	0	0	0	0	0	0	0	0	0	31
23:00	0	28	0	0	0	1	0	1	0	0	0	0	0	0	0	30
23:15	0	18	2	0	0	1	0	0	0	0	0	0	0	0	0	21
23:30	0	16	0	0	0	0	0	0	0	0	0	0	0	1	0	17
23:45	0	87	6	0	0	4	0	1	0	0	0	0	0	1	0	99
24:00	0	12	1	0	0	0	0	0	0	0	0	0	0	0	0	13
24:15	0	15	2	0	1	0	0	0	0	0	0	0	0	0	0	18
24:30	1	16	2	0	0	2	0	0	0	0	0	0	0	1	0	22
24:45	0	5	2	0	0	1	0	0	0	0	0	0	0	0	0	8
Total	1	48	7	0	1	3	0	0	0	0	0	0	0	1	0	61
Percent	0.2%	83.3%	10.3%	0.2%	1.5%	3.1%	0.0%	0.4%	0.2%	0.0%	0.0%	0.0%	0.0%	0.9%	0.0%	551

Tri-State Traffic Data, Inc

184 Baker Rd
Coatesville, PA 19320

Site Code: NY 211
Station ID: 000000000000
41.514745 -74.249629

Latitude: 0' 0.0000 Undefined

Direction 1 North

Start Time	Class 1	Class 2	Class 3	Class 4	Class 5	Class 6	Class 7	Class 8	Class 9	Class 10	Class 11	Class 12	Class 13	Class 14	Class 15	Total
06/05/1																
9	0	11	0	0	0	1	0	0	0	0	0	0	0	0	0	12
00:15	0	11	0	0	0	0	0	0	0	0	0	0	0	0	0	11
00:30	0	8	1	0	0	0	0	0	0	0	0	0	0	0	0	9
00:45	0	5	0	0	0	1	0	0	0	0	0	0	0	0	0	6
	0	35	1	0	0	2	0	0	0	0	0	0	0	0	0	38
01:00	0	6	1	0	0	0	0	0	2	0	0	0	0	0	0	9
01:15	0	7	0	0	0	0	0	0	0	0	0	0	0	0	0	7
01:30	0	1	0	0	0	0	0	0	0	0	0	0	0	0	0	1
01:45	0	0	0	0	0	1	0	0	0	0	0	0	0	0	0	1
	0	14	1	0	0	1	0	0	2	0	0	0	0	0	0	18
02:00	0	3	0	0	0	0	0	0	0	0	0	0	0	0	0	3
02:15	0	4	1	0	0	0	0	0	0	0	0	0	0	0	0	5
02:30	0	0	0	0	0	1	0	0	0	0	0	0	0	1	0	2
02:45	0	2	0	0	0	0	0	0	1	0	0	0	0	0	0	3
	0	9	1	0	0	1	0	0	1	0	0	0	0	1	0	13
03:00	0	2	0	0	0	0	0	0	0	0	0	0	0	0	0	2
03:15	0	5	0	0	1	0	0	0	1	0	0	0	0	0	0	7
03:30	0	0	1	0	0	2	0	0	0	0	0	0	0	0	0	3
03:45	0	4	0	0	0	0	0	0	0	0	0	0	0	0	0	4
	0	11	1	0	1	2	0	0	1	0	0	0	0	0	0	16
04:00	0	5	1	1	0	2	0	0	0	0	0	0	0	0	0	9
04:15	0	2	0	0	1	0	1	1	0	0	0	0	0	0	0	5
04:30	0	4	0	1	0	0	0	0	0	0	0	0	0	0	0	5
04:45	0	5	1	1	0	0	0	0	0	0	0	0	0	0	0	7
	0	16	2	3	1	2	1	1	0	0	0	0	0	0	0	26
05:00	0	2	0	2	0	0	0	0	0	0	0	0	0	0	0	4
05:15	0	5	3	0	0	0	0	0	0	0	0	0	0	0	0	8
05:30	0	4	1	0	0	0	0	0	0	0	0	0	0	1	0	6
05:45	0	7	3	1	0	0	0	0	1	0	0	0	0	1	0	13
	0	18	7	3	0	0	0	0	1	0	0	0	0	2	0	31
06:00	0	9	2	1	1	1	0	0	0	0	0	0	0	0	0	14
06:15	0	11	3	0	1	0	0	0	0	0	0	0	0	1	0	16
06:30	0	11	3	0	3	1	0	0	0	0	0	0	0	1	0	19
06:45	0	26	9	2	1	2	0	0	2	0	0	0	0	2	0	44
	0	57	17	3	6	4	0	0	2	0	0	0	0	4	0	93
07:00	0	25	4	1	0	1	0	0	0	0	0	0	0	1	0	32
07:15	0	26	7	1	1	1	0	0	0	0	0	0	0	1	0	37
07:30	0	28	4	0	2	2	0	0	0	0	0	0	0	2	0	38
07:45	0	57	6	3	1	1	0	0	0	0	0	0	0	2	0	70
	0	136	21	5	4	5	0	0	0	0	0	0	0	6	0	177
08:00	0	35	5	3	4	1	0	0	0	0	0	0	0	0	0	48
08:15	0	40	8	0	3	2	0	1	0	0	0	0	0	1	0	55
08:30	0	31	7	0	1	2	0	0	0	0	0	0	0	3	0	44
08:45	0	37	7	1	3	3	0	0	0	0	0	0	0	1	0	52
	0	143	27	4	11	8	0	1	0	0	0	0	0	5	0	199
09:00	0	43	9	3	0	3	0	0	2	0	0	0	0	0	0	60
09:15	0	37	6	1	2	1	0	0	0	0	0	0	0	0	0	47
09:30	0	36	8	0	1	1	0	0	1	0	0	0	0	0	0	47
09:45	1	34	14	0	1	2	0	0	0	0	0	0	0	0	0	52
	1	150	37	4	4	7	0	0	3	0	0	0	0	0	0	206
10:00	0	36	6	0	5	2	0	3	0	0	0	0	0	2	0	54
10:15	1	36	15	1	2	1	0	1	1	0	0	0	0	0	0	58
10:30	0	33	8	0	0	2	0	0	1	0	0	0	0	1	0	45
10:45	0	44	6	2	2	0	0	0	0	0	0	0	0	0	0	54
	1	149	35	3	9	5	0	4	2	0	0	0	0	3	0	211
11:00	0	38	11	1	1	2	0	0	0	0	0	0	0	0	0	53
11:15	0	44	9	3	1	2	0	1	0	0	0	0	0	0	0	60
11:30	0	43	13	0	0	2	1	0	0	0	0	0	0	0	0	59
11:45	1	51	9	3	3	1	0	1	0	0	0	0	0	0	0	69
	1	176	42	7	5	7	1	2	0	0	0	0	0	0	0	241
Total	3	914	192	32	41	44	2	8	12	0	0	0	0	21	0	1269
Percent	0.2%	72.0%	15.1%	2.5%	3.2%	3.5%	0.2%	0.6%	0.9%	0.0%	0.0%	0.0%	0.0%	1.7%	0.0%	

Tri-State Traffic Data, Inc

184 Baker Rd
Coatesville, PA 19320

Site Code: NY 211
Station ID: 000000000000
41.514745 -74.249629

Latitude: 0' 0.0000 Undefined

Direction 1 North

Start Time	Class 1	Class 2	Class 3	Class 4	Class 5	Class 6	Class 7	Class 8	Class 9	Class 10	Class 11	Class 12	Class 13	Class 14	Class 15	Total
12 PM	0	41	8	0	2	1	0	1	1	0	0	0	0	0	0	54
12:15	0	60	9	0	0	1	1	0	0	0	0	0	0	0	0	71
12:30	1	58	10	0	3	0	2	0	1	0	0	0	0	2	0	77
12:45	0	64	13	1	4	1	0	0	1	0	0	0	0	1	0	85
	1	223	40	1	9	3	3	1	3	0	0	0	0	3	0	287
13:00	1	49	10	0	7	2	0	0	0	1	0	0	0	1	0	71
13:15	1	57	8	0	8	0	0	1	0	0	0	0	0	0	0	75
13:30	0	54	11	0	1	0	0	0	0	0	0	0	0	0	0	66
13:45	0	64	12	0	1	1	0	2	0	0	0	0	0	0	0	80
	2	224	41	0	17	3	0	3	0	1	0	0	0	1	0	292
14:00	0	55	14	2	2	0	0	0	0	0	0	0	0	1	0	74
14:15	0	62	14	1	3	0	1	0	0	0	0	0	0	0	0	81
14:30	0	65	18	1	3	0	0	2	1	0	0	0	0	1	0	91
14:45	0	92	12	0	1	0	0	1	0	0	0	0	0	0	0	106
	0	274	58	4	9	0	1	3	1	0	0	0	0	2	0	352
15:00	0	79	14	0	5	3	0	0	1	0	0	0	0	0	0	102
15:15	1	94	13	0	3	1	1	0	1	0	0	0	0	0	0	114
15:30	2	88	14	1	2	3	0	0	0	1	0	0	1	1	0	113
15:45	1	94	17	0	2	2	1	1	0	0	0	0	0	0	0	118
	4	355	58	1	12	9	2	1	2	1	0	0	1	1	0	447
16:00	0	89	14	1	1	1	0	3	2	0	0	0	0	0	0	111
16:15	1	107	14	1	0	1	0	0	0	0	0	0	0	0	0	124
16:30	0	116	20	0	1	0	1	0	0	0	0	0	0	0	0	138
16:45	0	105	22	0	2	1	0	1	0	1	0	0	0	0	0	132
	1	417	70	2	4	3	1	4	2	1	0	0	0	0	0	505
17:00	0	95	14	0	3	1	0	2	0	0	0	0	0	1	0	116
17:15	2	145	17	0	3	2	0	1	0	0	0	0	0	1	0	171
17:30	0	106	14	0	3	0	0	1	0	0	0	0	0	1	0	125
17:45	2	97	20	0	3	0	0	0	0	0	0	0	0	0	0	122
	4	443	65	0	12	3	0	4	0	0	0	0	0	3	0	534
18:00	0	86	6	0	1	2	0	1	1	0	0	0	0	0	0	97
18:15	0	64	13	0	1	0	0	1	0	0	0	0	1	0	0	80
18:30	0	78	10	0	1	2	0	0	0	0	0	0	0	1	0	92
18:45	1	69	7	0	2	3	0	0	0	0	0	0	0	1	0	83
	1	297	36	0	5	7	0	2	1	0	0	0	1	2	0	352
19:00	1	56	9	0	4	1	0	0	0	0	0	0	0	1	0	72
19:15	0	73	16	0	5	0	0	0	0	0	0	0	0	1	0	95
19:30	0	59	17	0	2	0	0	0	1	0	0	0	0	1	0	80
19:45	0	56	12	0	1	1	0	0	0	0	0	0	0	0	0	70
	1	244	54	0	12	2	0	0	1	0	0	0	0	3	0	317
20:00	0	49	7	0	1	0	0	0	0	0	0	0	0	0	0	57
20:15	0	52	10	0	3	0	0	0	0	0	0	0	0	0	0	65
20:30	1	45	6	0	2	0	0	0	0	0	0	0	0	1	0	55
20:45	0	44	8	0	1	0	0	1	0	0	0	0	0	0	0	54
	1	190	31	0	7	0	0	1	0	0	0	0	0	1	0	231
21:00	0	30	4	0	0	1	0	0	0	0	0	0	0	0	0	35
21:15	0	39	2	0	0	0	0	0	0	0	0	0	0	0	0	41
21:30	0	26	4	0	1	1	1	0	0	0	0	0	0	0	0	33
21:45	0	31	2	0	0	0	0	0	0	0	0	0	0	0	0	33
	0	126	12	0	1	2	1	0	0	0	0	0	0	0	0	142
22:00	0	29	2	0	1	1	0	0	0	0	0	0	0	0	0	33
22:15	0	19	0	0	0	0	0	0	0	0	0	0	0	0	0	19
22:30	0	20	0	0	0	0	0	0	0	0	0	0	0	0	0	20
22:45	0	14	3	0	0	0	0	0	0	0	0	0	0	0	0	17
	0	82	5	0	1	1	0	0	0	0	0	0	0	0	0	89
23:00	0	16	1	0	1	0	0	0	0	0	0	0	0	0	0	18
23:15	0	16	4	0	2	0	0	0	0	0	0	0	0	0	0	22
23:30	0	19	2	0	0	1	0	0	0	0	0	0	0	0	0	22
23:45	0	7	1	0	0	0	0	0	0	0	0	0	0	0	0	8
	0	58	8	0	3	1	0	0	0	0	0	0	0	0	0	70
Total	15	2933	478	8	92	34	8	19	10	3	0	0	2	16	0	3618
Percent	0.4%	81.1%	13.2%	0.2%	2.5%	0.9%	0.2%	0.5%	0.3%	0.1%	0.0%	0.0%	0.1%	0.4%	0.0%	

Tri-State Traffic Data, Inc
 184 Baker Rd
 Coatesville, PA 19320

Site Code: NY 211
 Station ID: 000000000000
 41.514745 -74.249629

Latitude: 0' 0.0000 Undefined

Direction 1 North

Start Time	Class 1	Class 2	Class 3	Class 4	Class 5	Class 6	Class 7	Class 8	Class 9	Class 10	Class 11	Class 12	Class 13	Class 14	Class 15	Total
06/06/1																
9	0	5	0	0	0	0	0	0	0	0	0	0	0	1	0	6
00:15	0	7	0	0	0	0	0	0	0	0	0	0	0	0	0	7
00:30	0	10	1	0	0	0	0	0	0	0	0	0	0	0	0	11
00:45	0	4	1	0	0	0	0	0	0	0	0	0	0	0	0	5
	0	26	2	0	0	0	0	0	0	0	0	0	0	1	0	29
01:00	0	1	0	0	0	0	0	0	0	0	0	0	0	0	0	1
01:15	0	9	0	0	0	0	0	0	0	0	0	0	0	0	0	9
01:30	0	2	1	0	0	0	0	0	0	0	0	0	0	0	0	3
01:45	0	1	1	0	0	0	0	0	0	0	0	0	0	0	0	2
	0	13	2	0	0	0	0	0	0	0	0	0	0	0	0	15
02:00	0	3	0	0	0	0	0	0	0	0	0	0	0	1	0	4
02:15	0	2	0	0	0	0	0	0	0	0	0	0	0	0	0	2
02:30	0	1	1	0	0	1	0	0	0	0	0	0	0	0	0	3
02:45	0	4	0	0	0	0	0	0	0	0	0	0	0	0	0	4
	0	10	1	0	0	1	0	0	0	0	0	0	0	1	0	13
03:00	0	2	0	0	0	2	0	0	0	0	0	0	0	0	0	4
03:15	0	1	0	0	1	0	0	0	0	0	0	0	0	0	0	2
03:30	0	6	0	0	0	0	0	0	0	0	0	0	0	0	0	6
03:45	0	0	1	0	0	2	0	0	1	0	0	0	0	0	0	4
	0	9	1	0	1	4	0	0	1	0	0	0	0	0	0	16
04:00	0	1	0	0	0	1	0	0	1	0	0	0	0	0	0	3
04:15	0	4	1	1	0	2	0	0	0	0	1	0	0	0	0	9
04:30	1	5	0	1	0	0	0	0	0	0	0	0	0	0	0	7
04:45	0	0	0	2	0	0	0	0	0	0	0	0	0	0	0	2
	1	10	1	4	0	3	0	0	1	0	1	0	0	0	0	21
05:00	0	4	2	1	0	2	0	0	0	0	0	0	0	0	0	9
05:15	0	1	0	0	0	0	0	0	0	0	0	0	0	0	0	1
05:30	0	6	2	1	0	2	0	0	0	0	0	0	0	0	0	11
05:45	0	10	2	0	0	2	0	0	1	0	0	0	1	0	0	16
	0	21	6	2	0	6	0	0	1	0	0	0	1	0	0	37
06:00	0	9	0	0	1	3	0	0	0	0	0	0	0	0	0	13
06:15	0	15	3	0	0	2	0	0	1	0	0	0	0	0	0	21
06:30	0	19	5	0	2	2	0	0	1	0	0	0	0	0	0	29
06:45	1	31	7	3	3	4	0	0	1	0	0	0	0	0	0	50
	1	74	15	3	6	11	0	0	3	0	0	0	0	0	0	113
07:00	0	29	3	2	0	0	0	0	0	1	0	0	0	0	0	35
07:15	0	31	7	1	2	3	0	0	0	0	0	0	0	0	0	44
07:30	0	34	7	0	2	2	0	0	0	0	0	0	0	2	0	47
07:45	0	45	7	2	4	4	0	0	0	0	0	0	0	0	0	62
	0	139	24	5	8	9	0	0	0	1	0	0	0	2	0	188
08:00	0	42	12	3	2	3	0	0	1	0	0	0	0	1	0	64
08:15	0	39	6	0	2	3	0	0	0	0	0	0	1	0	0	51
08:30	0	33	10	0	1	0	0	0	0	0	0	0	0	3	0	47
08:45	0	38	8	2	3	0	0	2	0	0	0	0	0	0	0	53
	0	152	36	5	8	6	0	2	1	0	0	0	1	4	0	215
09:00	0	42	10	2	6	1	0	2	0	0	0	0	0	0	0	63
09:15	0	42	10	1	1	1	0	2	1	0	0	0	0	0	0	58
09:30	1	43	9	0	0	1	0	0	0	0	0	0	0	0	0	54
09:45	0	33	8	0	2	0	0	0	3	0	0	0	0	0	0	46
	1	160	37	3	9	3	0	4	4	0	0	0	0	0	0	221
10:00	0	40	8	1	3	0	0	0	0	0	0	0	0	1	0	53
10:15	1	38	13	0	1	0	0	0	1	0	0	0	0	0	0	54
10:30	0	35	10	0	0	0	0	0	0	0	0	0	0	0	0	45
10:45	2	59	12	1	3	0	0	1	2	0	0	0	0	0	0	80
	3	172	43	2	7	0	0	1	3	0	0	0	1	0	0	232
11:00	1	57	8	0	2	1	0	0	0	0	0	0	0	0	0	69
11:15	0	41	15	0	3	1	0	0	0	0	0	0	0	0	0	60
11:30	3	46	6	0	0	4	0	1	0	0	0	0	0	0	0	60
11:45	0	55	16	1	2	3	0	0	1	0	0	0	0	1	0	79
	4	199	45	1	7	9	0	1	1	0	0	0	0	1	0	268
Total	10	985	213	25	46	52	0	8	15	1	1	0	3	9	0	1368
Percent	0.7%	72.0%	15.6%	1.8%	3.4%	3.8%	0.0%	0.6%	1.1%	0.1%	0.1%	0.0%	0.2%	0.7%	0.0%	

Tri-State Traffic Data, Inc

184 Baker Rd
Coatesville, PA 19320

Site Code: NY 211
Station ID: 000000000000
41.514745 -74.249629

Latitude: 0' 0.0000 Undefined

Direction 1 North

Start Time	Class 1	Class 2	Class 3	Class 4	Class 5	Class 6	Class 7	Class 8	Class 9	Class 10	Class 11	Class 12	Class 13	Class 14	Class 15	Total
12 PM	1	76	8	3	1	1	0	1	0	0	0	0	0	0	0	91
12:15	0	61	9	1	2	1	0	0	0	0	0	0	0	0	0	74
12:30	0	77	8	1	1	0	0	1	0	0	0	0	0	0	0	88
12:45	1	62	16	1	3	1	0	1	0	0	0	0	0	0	0	85
	2	276	41	6	7	3	0	3	0	0	0	0	0	0	0	338
13:00	0	55	12	0	3	1	0	0	1	0	0	0	0	1	0	73
13:15	0	49	7	0	2	1	1	1	0	0	0	1	0	0	0	62
13:30	0	65	12	0	5	3	0	1	0	0	0	0	0	0	0	86
13:45	0	62	12	0	2	2	0	0	0	0	0	0	0	0	0	78
	0	231	43	0	12	7	1	2	1	0	0	1	0	1	0	299
14:00	0	56	11	0	2	0	0	1	1	0	0	0	0	0	0	71
14:15	1	81	10	4	4	1	0	1	0	0	0	0	0	1	0	103
14:30	0	82	12	1	3	1	0	2	0	0	0	0	0	1	0	102
14:45	1	94	12	1	6	0	0	0	0	0	0	0	0	1	0	115
	2	313	45	6	15	2	0	4	1	0	0	0	0	3	0	391
15:00	0	88	18	1	5	1	0	0	0	0	0	0	0	1	0	114
15:15	0	87	13	0	4	2	0	0	1	0	0	0	0	0	0	107
15:30	0	101	14	5	3	1	0	0	0	0	0	0	0	0	0	124
15:45	0	96	16	0	3	0	0	2	0	0	0	0	0	0	0	117
	0	372	61	6	15	4	0	2	1	0	0	0	0	1	0	462
16:00	0	88	12	0	7	2	0	0	0	0	0	0	0	0	0	109
16:15	1	132	13	0	3	1	0	1	2	0	0	0	0	0	0	153
16:30	0	104	15	1	2	1	1	0	1	0	0	0	0	0	0	125
16:45	1	105	24	0	1	1	0	0	0	0	0	0	0	0	0	132
	2	429	64	1	13	5	1	1	3	0	0	0	0	0	0	519
17:00	1	136	16	0	3	0	0	1	0	0	0	0	0	0	0	157
17:15	1	125	19	0	2	0	0	2	0	0	0	0	0	0	0	149
17:30	0	84	18	1	2	4	0	1	0	0	0	0	0	2	0	112
17:45	0	98	18	0	2	0	0	0	0	0	0	0	0	0	0	118
	2	443	71	1	9	4	0	4	0	0	0	0	0	2	0	536
18:00	1	74	11	0	4	0	0	1	1	0	0	0	0	1	0	93
18:15	0	75	18	0	5	1	0	0	0	0	0	0	0	0	0	99
18:30	1	67	8	0	3	0	0	0	0	0	0	0	0	0	0	79
18:45	2	64	13	0	4	0	0	0	0	0	0	0	0	1	0	84
	4	280	50	0	16	1	0	1	1	0	0	0	0	2	0	355
19:00	2	66	17	0	2	1	0	0	0	0	0	0	0	0	0	88
19:15	0	48	7	1	1	1	0	1	0	0	0	0	0	0	0	59
19:30	0	43	12	0	0	1	0	1	0	0	0	0	0	0	0	57
19:45	3	63	7	0	0	0	0	0	0	0	0	0	0	0	0	73
	5	220	43	1	3	3	0	2	0	0	0	0	0	0	0	277
20:00	0	52	10	0	1	1	0	0	0	0	0	0	0	1	0	65
20:15	0	51	11	0	0	0	0	0	0	0	0	0	0	0	0	62
20:30	0	44	7	0	1	1	0	0	0	0	0	0	0	0	0	53
20:45	1	40	6	0	0	0	0	0	0	0	0	0	0	0	0	47
	1	187	34	0	2	2	0	0	0	0	0	0	0	1	0	227
21:00	0	43	3	0	0	1	0	1	0	1	0	0	0	0	0	49
21:15	0	48	1	0	1	1	0	0	0	0	0	0	0	0	0	51
21:30	1	30	10	0	1	0	0	0	0	0	0	0	0	0	0	42
21:45	0	31	5	0	1	0	0	0	0	0	0	0	0	0	0	37
	1	152	19	0	3	2	0	1	0	1	0	0	0	0	0	179
22:00	0	24	4	0	2	1	0	0	0	0	0	0	0	0	0	31
22:15	0	15	0	0	0	3	0	0	0	0	0	0	0	0	0	18
22:30	0	15	3	0	0	0	0	0	0	0	0	0	0	0	0	18
22:45	0	15	2	0	0	0	0	0	0	0	0	0	0	0	0	17
	0	69	9	0	2	4	0	0	0	0	0	0	0	0	0	84
23:00	0	19	2	0	0	0	0	0	0	0	0	0	0	0	0	21
23:15	0	16	3	0	0	0	0	0	0	0	0	0	0	0	0	19
23:30	1	19	1	0	0	1	0	0	0	0	0	0	0	0	0	22
23:45	0	14	2	0	0	0	0	0	0	0	0	0	0	0	0	16
	1	68	8	0	0	1	0	0	0	0	0	0	0	0	0	78
Total	20	3040	488	21	97	38	2	20	7	1	0	1	0	10	0	3745
Percent	0.5%	81.2%	13.0%	0.6%	2.6%	1.0%	0.1%	0.5%	0.2%	0.0%	0.0%	0.0%	0.0%	0.3%	0.0%	

Tri-State Traffic Data, Inc

184 Baker Rd
Coatesville, PA 19320

Site Code: NY 211
Station ID: 000000000000
41.514745 -74.249629

Latitude: 0' 0.0000 Undefined

Direction 1 North

Start Time	Class 1	Class 2	Class 3	Class 4	Class 5	Class 6	Class 7	Class 8	Class 9	Class 10	Class 11	Class 12	Class 13	Class 14	Class 15	Total
06/07/1																
9	0	10	1	0	0	0	0	0	0	0	0	0	0	0	0	11
00:15	0	11	1	0	0	0	0	0	0	0	0	0	0	0	0	12
00:30	1	2	1	0	0	0	0	0	0	0	0	0	0	0	0	4
00:45	0	6	0	0	0	1	0	0	0	0	0	0	0	0	0	7
	1	29	3	0	0	1	0	0	0	0	0	0	0	0	0	34
01:00	0	6	0	0	0	0	0	0	0	0	0	0	0	0	0	6
01:15	0	6	1	0	0	0	0	0	0	0	0	0	0	1	0	8
01:30	0	4	0	0	1	0	0	1	0	0	0	0	0	0	0	6
01:45	0	2	1	0	0	0	0	0	0	0	0	0	0	0	0	3
	0	18	2	0	1	0	0	1	0	0	0	0	0	1	0	23
02:00	0	4	0	0	0	0	0	0	0	0	0	0	0	0	0	4
02:15	0	1	0	0	0	0	0	0	1	0	0	0	0	0	0	2
02:30	0	5	0	0	0	0	0	0	0	0	0	0	0	0	0	5
02:45	0	2	0	0	0	0	1	0	0	0	0	0	0	0	0	3
	0	12	0	0	0	0	1	0	1	0	0	0	0	0	0	14
03:00	0	3	2	0	0	0	0	0	0	0	0	0	0	0	0	5
03:15	0	1	0	0	0	0	0	0	0	0	0	0	0	0	0	1
03:30	0	1	1	0	0	0	0	0	3	0	0	0	0	0	0	5
03:45	0	6	0	0	0	0	0	0	1	0	0	0	0	0	0	7
	0	11	3	0	0	0	0	0	4	0	0	0	0	0	0	18
04:00	0	1	0	0	1	1	0	0	0	0	0	0	0	0	0	3
04:15	0	2	0	1	0	0	0	0	0	0	0	0	0	0	0	3
04:30	0	2	0	1	0	0	0	0	0	0	0	0	0	0	0	3
04:45	0	3	1	1	0	1	0	0	0	0	0	0	0	0	0	6
	0	8	1	3	1	2	0	0	0	0	0	0	0	0	0	15
05:00	0	5	0	2	0	0	0	0	0	0	0	0	0	0	0	7
05:15	0	4	1	0	0	0	0	0	0	0	0	0	0	0	0	5
05:30	0	4	1	1	0	0	0	0	0	0	0	0	0	0	0	6
05:45	0	9	1	1	0	2	0	0	0	0	0	0	0	0	0	13
	0	22	3	4	0	2	0	0	0	0	0	0	0	0	0	31
06:00	0	5	3	0	1	2	0	0	0	0	0	0	0	0	0	11
06:15	0	15	3	0	1	0	0	0	0	0	0	0	0	1	0	20
06:30	1	18	2	0	3	0	0	0	0	0	0	0	0	0	0	24
06:45	0	27	9	3	1	1	0	1	1	0	0	0	0	0	0	43
	1	65	17	3	6	3	0	1	1	0	0	0	0	1	0	98
07:00	0	26	3	1	0	2	0	0	0	0	0	0	0	1	0	33
07:15	0	26	6	1	5	2	0	0	0	0	0	0	0	0	0	40
07:30	1	39	5	1	1	3	0	0	0	0	0	0	0	0	0	50
07:45	0	46	5	3	1	1	0	1	0	0	0	0	0	0	0	57
	1	137	19	6	7	8	0	1	0	0	0	0	0	1	0	180
08:00	1	33	7	1	3	2	0	0	0	0	0	0	0	0	0	47
08:15	4	37	5	1	2	0	0	0	0	0	0	0	0	1	0	50
08:30	0	38	7	0	3	3	1	0	0	0	0	0	0	2	0	54
08:45	0	39	6	1	3	3	0	0	0	0	0	0	0	0	0	52
	5	147	25	3	11	8	1	0	0	0	0	0	0	3	0	203
09:00	1	51	9	3	0	0	0	0	0	0	0	0	1	1	0	66
09:15	0	30	9	1	2	1	0	0	1	0	0	0	0	0	0	44
09:30	0	36	8	2	0	0	0	0	0	0	0	0	0	1	0	47
09:45	0	30	8	0	4	3	0	2	0	0	0	0	1	2	0	50
	1	147	34	6	6	4	0	2	1	0	0	0	2	4	0	207
10:00	0	29	4	1	2	1	0	0	2	0	0	0	0	1	0	40
10:15	0	36	9	1	2	1	0	0	0	0	0	0	0	0	0	49
10:30	0	46	10	0	4	0	0	0	0	0	0	0	0	0	0	60
10:45	2	61	13	0	3	0	0	1	0	0	0	0	1	1	0	82
	2	172	36	2	11	2	0	1	2	0	0	0	1	2	0	231
11:00	0	42	7	3	5	2	0	2	0	0	0	0	0	0	0	61
11:15	1	46	8	0	6	1	0	1	0	0	0	0	0	0	0	63
11:30	1	64	16	0	3	2	0	0	1	0	0	0	0	0	0	87
11:45	0	55	10	0	2	1	0	1	0	0	0	0	0	0	0	69
	2	207	41	3	16	6	0	4	1	0	0	0	0	0	0	280
Total	13	975	184	30	59	36	2	10	10	0	0	0	3	12	0	1334
Percent	1.0%	73.1%	13.8%	2.2%	4.4%	2.7%	0.1%	0.7%	0.7%	0.0%	0.0%	0.0%	0.2%	0.9%	0.0%	

Tri-State Traffic Data, Inc

184 Baker Rd
Coatesville, PA 19320

Site Code: NY 211
Station ID: 000000000000
41.514745 -74.249629

Latitude: 0' 0.0000 Undefined

Direction 1 North

Start Time	Class 1	Class 2	Class 3	Class 4	Class 5	Class 6	Class 7	Class 8	Class 9	Class 10	Class 11	Class 12	Class 13	Class 14	Class 15	Total
12 PM	2	84	19	1	5	2	1	3	1	0	0	0	0	1	0	119
12:15	2	75	15	1	4	4	0	0	0	0	0	0	0	0	0	101
12:30	0	65	8	0	2	4	0	1	1	0	0	0	0	0	0	81
12:45	0	61	6	0	3	1	0	1	1	0	0	0	0	0	0	73
13:00	4	285	48	2	14	11	1	5	3	0	0	0	0	1	0	374
13:15	1	63	8	1	2	0	0	3	1	0	0	0	0	0	0	79
13:30	0	90	18	0	1	0	0	1	2	0	0	0	0	0	0	112
13:45	1	59	17	0	2	2	0	0	0	0	0	0	0	0	0	81
14:00	3	289	59	1	7	5	0	4	3	0	0	0	0	0	0	371
14:15	0	87	14	0	4	1	0	1	0	0	0	0	1	0	0	108
14:30	0	80	13	2	3	1	0	1	1	0	0	0	0	0	0	101
14:45	0	80	12	1	4	0	0	1	1	0	0	0	0	1	0	100
15:00	1	91	21	1	4	0	0	2	0	0	0	0	0	1	0	121
15:15	1	338	60	4	15	2	0	5	2	0	0	0	1	2	0	430
15:30	2	92	19	0	3	0	0	2	0	0	0	0	0	1	0	119
15:45	1	98	18	2	5	1	0	0	0	0	0	0	0	0	0	125
16:00	0	78	11	1	6	1	1	0	0	0	0	0	0	0	0	98
16:15	2	102	13	0	2	0	0	0	0	0	0	0	0	0	0	119
16:30	5	370	61	3	16	2	1	2	0	0	0	0	0	1	0	461
16:45	1	83	14	1	5	0	0	0	1	0	0	0	0	0	0	105
17:00	2	128	17	1	5	2	0	1	1	0	0	0	0	0	0	157
17:15	0	110	13	1	3	1	1	0	0	0	0	0	0	0	0	129
17:30	0	80	18	1	1	1	0	1	0	1	0	0	0	0	0	103
17:45	3	401	62	4	14	4	1	2	2	1	0	0	0	0	0	494
18:00	5	105	15	1	3	0	0	1	0	0	0	0	0	0	0	130
18:15	0	111	23	0	3	3	0	0	0	0	0	0	0	0	0	140
18:30	1	99	12	0	1	1	0	3	2	0	0	0	0	0	0	119
18:45	2	98	9	2	2	1	0	0	0	0	0	0	0	0	0	114
19:00	8	413	59	3	9	5	0	4	2	0	0	0	0	0	0	503
19:15	0	95	12	0	3	0	1	2	0	0	0	0	0	0	0	113
19:30	1	120	20	1	1	1	0	0	0	0	0	0	0	0	0	144
19:45	0	56	7	0	1	2	0	0	0	0	0	0	0	0	0	66
20:00	0	66	12	0	2	0	0	0	0	0	0	0	0	0	0	80
20:15	1	337	51	1	7	3	1	2	0	0	0	0	0	0	0	403
20:30	4	69	9	1	1	1	0	0	0	0	0	0	0	1	0	86
20:45	2	67	10	1	1	1	0	1	0	0	0	0	0	0	0	83
21:00	0	70	4	0	3	1	0	0	0	0	0	0	0	0	0	78
21:15	1	55	8	0	1	1	0	0	0	0	0	0	0	0	0	66
21:30	7	261	31	2	6	4	0	1	0	0	0	0	0	1	0	313
21:45	0	53	8	0	0	1	0	0	0	0	0	0	0	0	0	62
22:00	0	61	4	0	1	1	0	0	0	0	0	0	0	0	0	67
22:15	0	52	10	0	1	3	0	0	0	0	0	0	0	0	0	66
22:30	0	34	8	1	0	2	0	0	0	0	0	0	0	0	0	45
22:45	0	200	30	1	2	7	0	0	0	0	0	0	0	0	0	240
23:00	0	43	10	0	0	0	0	0	0	0	0	0	0	0	0	53
23:15	0	41	7	0	0	1	0	0	0	0	0	0	0	0	0	49
23:30	1	37	4	0	1	1	0	0	0	0	0	0	0	0	0	44
23:45	0	44	7	0	2	0	0	0	0	0	0	0	0	0	0	53
24:00	1	165	28	0	3	2	0	0	0	0	0	0	0	0	0	199
24:15	0	34	4	0	2	1	0	0	0	0	0	0	0	0	0	41
24:30	0	21	1	0	1	0	0	0	0	0	0	0	0	0	0	23
24:45	0	36	0	0	0	3	0	0	1	0	0	0	0	1	0	41
25:00	1	42	2	0	1	1	0	0	0	0	0	0	0	0	0	47
25:15	1	133	7	0	4	5	0	0	1	0	0	0	0	1	0	152
25:30	0	36	1	1	2	0	0	0	0	0	0	0	0	0	0	40
25:45	0	38	4	0	0	1	0	0	0	0	0	0	0	0	0	43
26:00	0	21	1	0	0	0	0	0	0	0	0	0	0	0	0	22
26:15	1	25	2	0	0	1	0	0	0	0	0	0	0	1	0	30
26:30	1	120	8	1	2	2	0	0	0	0	0	0	0	1	0	135
Total	35	3312	504	22	99	52	4	25	13	1	0	0	1	7	0	4075
Percent	0.9%	81.3%	12.4%	0.5%	2.4%	1.3%	0.1%	0.6%	0.3%	0.0%	0.0%	0.0%	0.0%	0.2%	0.0%	

Tri-State Traffic Data, Inc

184 Baker Rd
Coatesville, PA 19320

Site Code: NY 211
Station ID: 000000000000
41.514745 -74.249629

Latitude: 0' 0.0000 Undefined

Direction 1 North

Start Time	Class 1	Class 2	Class 3	Class 4	Class 5	Class 6	Class 7	Class 8	Class 9	Class 10	Class 11	Class 12	Class 13	Class 14	Class 15	Total
06/08/1																
9	0	18	5	0	0	0	0	0	0	0	0	0	0	0	0	23
00:15	0	12	3	0	0	0	0	0	0	0	0	0	0	0	0	15
00:30	0	12	1	0	0	0	0	0	0	0	0	0	0	0	0	13
00:45	0	8	1	0	1	0	0	0	0	0	0	0	0	0	0	10
	0	50	10	0	1	0	0	0	0	0	0	0	0	0	0	61
01:00	0	12	0	0	0	0	0	0	0	0	0	0	0	0	0	12
01:15	1	10	0	0	0	1	0	0	0	0	0	0	0	0	0	12
01:30	0	10	0	0	0	0	0	0	0	0	0	0	0	0	0	10
01:45	0	4	2	0	0	0	0	0	0	0	0	0	0	0	0	6
	1	36	2	0	0	1	0	0	0	0	0	0	0	0	0	40
02:00	0	8	0	0	0	0	0	0	0	0	0	0	0	0	0	8
02:15	0	2	0	0	0	0	0	0	0	0	0	0	0	0	0	2
02:30	0	4	1	0	0	0	0	0	0	0	0	0	0	0	0	5
02:45	0	3	1	0	0	0	0	0	0	0	0	0	0	0	0	4
	0	17	2	0	0	0	0	0	0	0	0	0	0	0	0	19
03:00	0	1	0	0	0	0	0	0	0	0	0	0	0	0	0	1
03:15	0	3	0	0	0	1	0	0	0	0	0	0	0	0	0	4
03:30	0	4	0	0	0	0	0	0	1	0	0	0	0	0	0	5
03:45	0	2	0	0	0	0	0	0	0	0	0	0	0	0	0	2
	0	10	0	0	0	1	0	0	1	0	0	0	0	0	0	12
04:00	0	1	1	0	1	0	0	0	0	0	0	0	0	0	0	3
04:15	0	2	0	0	0	0	0	0	0	0	0	0	0	0	0	2
04:30	0	2	0	1	0	0	0	0	0	0	0	0	0	0	0	3
04:45	0	1	1	1	0	0	0	0	0	0	0	0	0	0	0	3
	0	6	2	2	1	0	0	0	0	0	0	0	0	0	0	11
05:00	0	0	1	0	0	0	0	0	0	0	0	0	0	0	0	1
05:15	1	5	0	0	1	0	0	0	0	0	0	0	0	0	0	7
05:30	0	1	0	0	1	0	0	0	0	0	0	0	0	0	0	2
05:45	0	8	1	1	0	0	0	0	0	0	0	0	0	0	0	10
	1	14	2	1	2	0	0	0	0	0	0	0	0	0	0	20
06:00	0	1	2	0	0	0	0	0	0	0	0	0	1	0	0	4
06:15	0	6	2	0	0	1	0	0	0	0	0	0	0	0	0	9
06:30	1	10	4	0	0	0	0	0	0	0	0	0	0	1	0	16
06:45	0	4	3	1	1	0	0	0	0	0	0	0	1	2	0	12
	1	21	11	1	1	1	0	0	0	0	0	0	2	3	0	41
07:00	0	8	3	0	1	0	1	0	0	0	0	0	0	1	0	14
07:15	0	14	2	0	1	1	0	0	0	0	0	0	1	0	0	19
07:30	0	23	0	1	3	1	0	0	2	1	0	0	0	1	0	32
07:45	2	23	6	0	2	0	0	1	0	0	0	0	0	1	0	35
	2	68	11	1	7	2	1	1	2	1	0	0	1	3	0	100
08:00	1	25	5	0	1	1	0	0	0	0	0	0	1	0	0	34
08:15	0	39	1	0	2	1	0	1	0	0	0	0	0	1	0	45
08:30	2	20	5	0	0	0	0	0	0	0	0	0	1	0	0	28
08:45	0	26	6	1	1	4	0	1	0	0	0	0	0	1	0	40
	3	110	17	1	4	6	0	2	0	0	0	0	2	2	0	147
09:00	0	30	10	0	2	1	0	0	1	0	0	0	0	0	0	44
09:15	0	43	3	0	3	2	0	0	1	0	0	0	0	3	0	55
09:30	0	39	7	1	2	1	0	1	0	0	0	0	0	0	0	51
09:45	0	49	8	0	0	2	1	1	1	0	0	0	0	0	0	62
	0	161	28	1	7	6	1	2	3	0	0	0	0	3	0	212
10:00	0	46	7	0	0	1	0	0	0	0	0	0	0	0	0	54
10:15	0	43	11	1	1	1	0	0	0	0	0	0	0	0	0	57
10:30	2	54	12	0	5	1	0	1	1	0	0	0	0	0	0	76
10:45	1	63	11	0	3	1	0	0	1	0	0	0	0	0	0	80
	3	206	41	1	9	4	0	1	2	0	0	0	0	0	0	267
11:00	1	70	11	0	4	3	0	0	0	0	0	0	0	1	0	90
11:15	1	65	9	0	0	1	0	2	0	0	0	0	0	0	0	78
11:30	2	56	11	0	0	3	1	1	0	0	0	0	0	0	0	74
11:45	2	57	16	0	3	1	0	1	0	0	1	0	0	0	0	81
	6	248	47	0	7	8	1	4	0	0	1	0	0	1	0	323
Total	17	947	173	8	39	29	3	10	8	1	1	0	5	12	0	1253
Percent	1.4%	75.6%	13.8%	0.6%	3.1%	2.3%	0.2%	0.8%	0.6%	0.1%	0.1%	0.0%	0.4%	1.0%	0.0%	

Tri-State Traffic Data, Inc

184 Baker Rd
Coatesville, PA 19320

Site Code: NY 211
Station ID: 000000000000
41.514745 -74.249629

Latitude: 0' 0.0000 Undefined

Direction 1 North

Start Time	Class 1	Class 2	Class 3	Class 4	Class 5	Class 6	Class 7	Class 8	Class 9	Class 10	Class 11	Class 12	Class 13	Class 14	Class 15	Total
12 PM	2	60	10	1	1	1	0	1	0	0	0	0	0	0	0	76
12:15	0	80	16	0	4	2	0	0	0	0	0	0	0	0	0	102
12:30	0	80	15	0	4	0	0	1	0	0	0	0	0	0	0	100
12:45	0	73	12	0	4	0	0	0	2	0	0	0	0	0	0	91
	2	293	53	1	13	3	0	2	2	0	0	0	0	0	0	369
13:00	0	80	7	1	2	1	0	0	1	0	0	0	0	0	0	92
13:15	1	78	16	0	3	1	0	1	1	0	0	0	0	0	0	101
13:30	3	69	13	0	1	1	0	0	0	0	0	0	0	1	0	88
13:45	1	67	6	0	1	0	0	0	0	0	0	0	0	0	0	75
	5	294	42	1	7	3	0	1	2	0	0	0	0	1	0	356
14:00	0	73	14	0	1	0	0	0	0	0	0	0	0	0	0	88
14:15	1	64	13	0	0	2	0	1	0	0	0	0	0	1	0	82
14:30	1	70	10	2	2	0	0	0	0	0	0	0	0	1	0	86
14:45	1	68	13	0	1	0	0	1	2	0	0	0	0	0	0	86
	3	275	50	2	4	2	0	2	2	0	0	0	0	2	0	342
15:00	0	64	4	0	4	2	0	0	0	0	0	0	0	0	0	74
15:15	2	68	10	0	0	0	0	0	0	0	0	0	0	0	0	80
15:30	2	60	6	0	0	1	0	0	0	0	0	0	0	0	0	69
15:45	3	69	9	0	2	2	0	0	0	0	0	0	0	0	0	85
	7	261	29	0	6	5	0	0	0	0	0	0	0	0	0	308
16:00	0	73	8	0	2	2	0	0	1	0	0	0	0	0	0	86
16:15	0	82	14	0	2	0	0	0	0	0	0	0	0	0	0	98
16:30	2	77	5	0	0	0	0	0	0	0	0	0	0	0	0	84
16:45	1	70	11	0	0	0	0	0	1	0	0	0	0	0	0	83
	3	302	38	0	4	2	0	0	2	0	0	0	0	0	0	351
17:00	1	64	11	0	0	0	0	2	0	0	0	0	0	0	0	78
17:15	5	67	8	0	1	0	0	0	0	0	0	0	0	0	0	81
17:30	3	43	9	1	0	0	0	0	0	0	0	0	0	0	0	56
17:45	0	49	7	0	1	1	0	0	0	0	0	0	0	0	0	58
	9	223	35	1	2	1	0	2	0	0	0	0	0	0	0	273
18:00	0	63	8	0	0	1	0	0	0	0	0	0	0	0	0	72
18:15	1	56	15	0	1	0	0	0	0	0	0	0	0	0	0	73
18:30	1	48	12	0	3	3	0	0	0	0	0	0	0	0	0	67
18:45	0	60	11	0	1	1	0	0	0	0	0	0	0	0	0	73
	2	227	46	0	5	5	0	0	0	0	0	0	0	0	0	285
19:00	1	55	11	0	1	0	0	0	0	0	0	0	0	0	0	68
19:15	2	51	7	0	1	1	0	0	0	0	0	0	0	0	0	62
19:30	2	53	10	0	2	0	0	0	0	0	0	0	0	0	0	67
19:45	0	57	5	0	1	1	0	0	0	0	0	0	0	0	0	64
	5	216	33	0	5	2	0	0	0	0	0	0	0	0	0	261
20:00	1	45	6	0	0	0	0	0	0	0	0	0	0	0	0	52
20:15	1	41	2	0	1	0	0	0	0	0	0	0	0	0	0	45
20:30	0	42	7	0	1	0	0	0	0	0	0	0	0	0	0	50
20:45	0	36	4	0	1	0	0	0	0	0	0	0	0	0	0	41
	2	164	19	0	3	0	0	0	0	0	0	0	0	0	0	188
21:00	0	32	4	0	1	1	0	0	0	0	0	0	0	0	0	38
21:15	0	38	5	0	0	0	0	0	0	0	0	0	0	0	0	43
21:30	1	39	2	0	0	0	0	0	0	0	0	0	0	0	0	42
21:45	0	38	3	0	0	0	0	0	0	0	0	0	0	0	0	41
	1	147	14	0	1	1	0	0	0	0	0	0	0	0	0	164
22:00	0	46	5	1	1	0	0	1	0	0	0	0	0	0	0	54
22:15	1	27	3	0	0	1	0	0	0	0	0	0	1	0	0	33
22:30	0	27	0	0	0	1	0	0	0	0	0	0	0	0	0	28
22:45	0	27	4	0	1	0	0	0	0	0	0	0	0	0	0	32
	1	127	12	1	2	2	0	1	0	0	0	0	1	0	0	147
23:00	0	17	3	0	1	0	0	0	0	0	0	0	0	0	0	21
23:15	0	20	3	0	0	0	0	0	0	0	0	0	0	0	0	23
23:30	0	18	2	1	0	0	0	0	0	0	0	0	0	0	0	21
23:45	0	17	2	0	1	1	0	0	0	0	0	0	0	0	0	21
	0	72	10	1	2	1	0	0	0	0	0	0	0	0	0	86
Total	40	2601	381	7	54	27	0	8	8	0	0	0	1	3	0	3130
Percent	1.3%	83.1%	12.2%	0.2%	1.7%	0.9%	0.0%	0.3%	0.3%	0.0%	0.0%	0.0%	0.0%	0.1%	0.0%	

Tri-State Traffic Data, Inc

184 Baker Rd
Coatesville, PA 19320

Site Code: NY 211
Station ID: 000000000000
41.514745 -74.249629

Latitude: 0' 0.0000 Undefined

Direction 1 North

Start Time	Class 1	Class 2	Class 3	Class 4	Class 5	Class 6	Class 7	Class 8	Class 9	Class 10	Class 11	Class 12	Class 13	Class 14	Class 15	Total
06/09/1	9	0	16	1	0	0	0	0	0	0	0	0	0	0	0	17
00:15	0	7	1	0	0	1	0	0	0	0	0	0	0	0	0	9
00:30	0	8	0	0	0	0	0	0	0	0	0	0	0	0	0	8
00:45	0	14	1	0	0	0	0	0	0	0	0	0	0	0	0	15
	0	45	3	0	0	1	0	0	0	0	0	0	0	0	0	49
01:00	0	9	3	0	0	0	0	0	0	0	0	0	0	0	0	12
01:15	0	7	0	0	0	0	0	0	0	0	0	0	0	0	0	7
01:30	0	9	0	0	0	0	0	0	0	0	0	0	0	0	0	9
01:45	0	6	1	0	0	0	0	0	0	0	0	0	0	0	0	7
	0	31	4	0	0	0	0	0	0	0	0	0	0	0	0	35
02:00	0	2	1	0	0	0	0	0	0	0	0	0	0	0	0	3
02:15	0	1	0	0	0	0	0	0	0	0	0	0	0	0	0	1
02:30	0	3	2	0	0	0	0	0	0	0	0	0	0	0	0	5
02:45	0	0	0	0	0	0	0	0	0	0	0	0	0	0	0	0
	0	6	3	0	0	0	0	0	0	0	0	0	0	0	0	9
03:00	0	3	0	0	1	0	0	0	0	0	0	0	0	0	0	4
03:15	0	2	0	0	0	0	0	0	0	0	0	0	0	0	0	2
03:30	0	0	1	0	0	0	0	0	0	0	0	0	0	0	0	1
03:45	0	1	0	0	0	0	0	0	0	0	0	0	0	0	0	1
	0	6	1	0	1	0	0	0	0	0	0	0	0	0	0	8
04:00	0	1	1	0	0	0	0	0	0	0	0	0	0	0	0	2
04:15	0	3	0	0	0	0	0	0	0	0	0	0	0	0	0	3
04:30	0	1	1	0	0	1	0	0	0	0	0	0	0	0	0	3
04:45	0	1	0	0	0	0	0	0	0	0	0	0	0	0	0	1
	0	6	2	0	0	1	0	0	0	0	0	0	0	0	0	9
05:00	0	0	1	0	0	0	0	0	0	0	0	0	0	0	0	1
05:15	0	3	0	0	0	0	0	0	0	0	0	0	0	0	0	3
05:30	0	3	0	0	0	0	0	0	0	0	0	0	0	0	0	3
05:45	0	2	1	1	1	1	0	0	0	0	0	0	0	0	0	6
	0	8	2	1	1	1	0	0	0	0	0	0	0	0	0	13
06:00	0	0	2	0	0	0	0	0	0	0	0	0	0	0	0	2
06:15	0	6	1	0	0	0	0	0	0	0	0	0	0	0	0	7
06:30	0	5	1	0	0	0	0	0	0	0	0	0	0	0	0	6
06:45	0	6	3	0	0	0	0	0	0	0	0	0	0	0	0	9
	0	17	7	0	0	0	0	0	0	0	0	0	0	0	0	24
07:00	0	7	1	0	0	0	0	0	0	0	0	0	0	0	0	8
07:15	0	10	3	0	0	0	0	0	0	0	0	0	0	0	0	13
07:30	0	8	1	0	1	0	0	0	0	0	0	0	0	0	0	10
07:45	0	14	3	0	0	0	0	0	0	0	0	0	0	0	0	17
	0	39	8	0	1	0	0	0	0	0	0	0	0	0	0	48
08:00	0	9	5	0	0	1	0	0	0	0	0	0	0	0	0	15
08:15	0	11	0	0	1	1	0	0	0	0	0	0	0	0	0	13
08:30	0	19	3	0	0	1	0	0	0	0	0	0	0	0	0	23
08:45	0	20	0	0	0	2	0	0	0	0	0	0	0	0	0	22
	0	59	8	0	1	5	0	0	0	0	0	0	0	0	0	73
09:00	0	15	2	0	1	2	0	0	0	0	0	0	0	0	0	20
09:15	0	17	4	1	1	0	0	0	0	0	0	0	0	0	0	23
09:30	0	34	9	0	3	1	0	0	0	0	0	0	0	1	0	48
09:45	0	32	5	0	1	1	0	0	0	0	0	0	0	0	0	39
	0	98	20	1	6	4	0	0	0	0	0	0	0	1	0	130
10:00	0	23	6	0	0	1	0	0	0	0	0	0	0	0	0	30
10:15	2	36	4	0	1	1	0	0	1	0	0	0	0	1	0	46
10:30	0	34	6	0	2	2	0	1	0	0	0	0	0	0	0	45
10:45	6	40	7	0	0	0	0	0	0	0	0	0	0	1	0	54
	8	133	23	0	3	4	0	1	1	0	0	0	0	2	0	175
11:00	1	52	2	0	0	1	0	1	0	0	0	0	0	0	0	57
11:15	1	47	10	0	1	4	0	0	0	0	0	0	0	0	0	63
11:30	1	57	13	0	0	0	0	0	0	0	0	0	0	0	0	71
11:45	6	58	9	1	0	1	0	0	0	0	0	0	0	0	0	75
	9	214	34	1	1	6	0	1	0	0	0	0	0	0	0	266
Total	17	662	115	3	14	22	0	2	1	0	0	0	0	3	0	839
Percent	2.0%	78.9%	13.7%	0.4%	1.7%	2.6%	0.0%	0.2%	0.1%	0.0%	0.0%	0.0%	0.0%	0.4%	0.0%	

Tri-State Traffic Data, Inc

184 Baker Rd
Coatesville, PA 19320

Site Code: NY 211
Station ID: 000000000000
41.514745 -74.249629

Latitude: 0' 0.0000 Undefined

Direction 1 North

Start Time	Class 1	Class 2	Class 3	Class 4	Class 5	Class 6	Class 7	Class 8	Class 9	Class 10	Class 11	Class 12	Class 13	Class 14	Class 15	Total
12 PM	1	61	7	0	1	1	0	0	0	0	0	0	0	0	0	71
12:15	6	62	11	0	0	0	0	0	0	0	0	0	0	0	0	79
12:30	2	68	9	0	2	0	0	0	1	0	0	0	0	0	0	82
12:45	1	55	5	0	3	1	0	0	0	1	0	0	0	0	0	66
	10	246	32	0	6	2	0	0	1	1	0	0	0	0	0	298
13:00	2	68	7	0	1	0	0	1	0	0	0	0	0	0	0	79
13:15	4	64	6	1	0	0	0	0	0	0	0	0	0	0	0	75
13:30	2	71	13	0	4	0	0	0	0	0	0	0	0	0	0	90
13:45	2	61	9	0	0	0	0	0	0	0	0	0	0	0	0	72
	10	264	35	1	5	0	0	1	0	0	0	0	0	0	0	316
14:00	2	64	12	0	0	2	0	0	0	0	0	0	0	0	0	80
14:15	1	70	11	0	1	0	0	0	1	0	0	0	0	0	0	84
14:30	3	56	3	1	1	0	0	0	0	0	0	0	0	0	0	64
14:45	4	62	10	0	0	0	0	0	0	0	0	0	0	0	0	76
	10	252	36	1	2	2	0	0	1	0	0	0	0	0	0	304
15:00	3	59	15	0	0	0	0	0	2	0	0	0	0	0	0	79
15:15	0	67	11	0	3	1	0	0	1	0	0	0	0	0	0	83
15:30	0	84	5	1	1	1	0	0	0	0	0	0	0	0	0	92
15:45	0	65	13	0	0	0	0	0	1	0	0	0	0	0	0	79
	3	275	44	1	4	2	0	0	4	0	0	0	0	0	0	333
16:00	2	70	8	0	0	1	0	0	0	0	0	0	0	0	0	81
16:15	2	53	8	0	1	0	0	0	0	0	0	0	0	0	0	64
16:30	3	61	8	1	1	2	0	0	0	0	0	0	0	0	0	76
16:45	2	68	8	0	0	0	0	0	0	0	0	0	0	0	0	78
	9	252	32	1	2	3	0	0	0	0	0	0	0	0	0	299
17:00	1	65	7	0	0	2	0	0	1	0	0	0	0	1	0	77
17:15	0	43	14	1	0	1	0	1	0	0	0	0	0	0	0	60
17:30	3	54	3	1	0	0	0	0	0	0	0	0	0	0	0	61
17:45	2	46	10	0	0	0	0	0	0	0	0	0	0	0	0	58
	6	208	34	2	0	3	0	1	1	0	0	0	0	1	0	256
18:00	2	43	10	0	2	0	0	0	0	0	0	0	0	0	0	57
18:15	2	47	10	0	0	0	0	1	0	0	0	0	0	0	0	60
18:30	3	50	4	0	1	0	0	0	0	0	0	0	0	0	0	58
18:45	1	41	5	0	0	1	0	0	0	0	0	0	0	0	0	48
	8	181	29	0	3	1	0	1	0	0	0	0	0	0	0	223
19:00	0	39	6	0	1	0	0	0	0	0	0	0	0	1	0	47
19:15	1	41	3	0	0	0	0	1	0	0	0	0	0	1	0	47
19:30	0	33	2	0	0	0	0	0	0	0	0	0	0	0	0	35
19:45	0	39	5	0	0	0	1	0	0	0	0	0	0	0	0	45
	1	152	16	0	1	0	1	1	0	0	0	0	0	2	0	174
20:00	1	34	5	0	3	1	0	0	0	0	0	0	0	0	0	44
20:15	0	33	3	0	0	0	0	0	0	0	0	0	0	0	0	36
20:30	0	40	3	0	0	0	0	0	0	0	0	0	0	0	0	43
20:45	0	29	5	0	0	0	0	0	0	0	0	0	0	0	0	34
	1	136	16	0	3	1	0	0	0	0	0	0	0	0	0	157
21:00	0	24	7	0	1	0	0	0	0	0	0	0	0	0	0	32
21:15	0	19	1	0	1	0	0	0	0	0	0	0	0	0	0	21
21:30	0	18	3	0	2	2	0	0	0	0	0	0	0	0	0	25
21:45	0	16	1	0	0	0	0	0	0	0	0	0	0	0	0	17
	0	77	12	0	4	2	0	0	0	0	0	0	0	0	0	95
22:00	0	10	1	0	0	0	0	0	0	0	0	0	0	0	0	11
22:15	0	15	1	0	1	0	0	0	0	0	0	0	0	0	0	17
22:30	0	14	2	0	0	0	0	0	0	0	0	0	0	0	0	16
22:45	0	14	1	0	0	0	0	0	0	0	0	0	0	0	0	15
	0	53	5	0	1	0	0	0	0	0	0	0	0	0	0	59
23:00	0	4	3	0	1	0	0	0	0	1	0	0	0	0	0	9
23:15	0	11	1	0	0	0	0	0	0	0	0	0	0	0	0	12
23:30	0	5	0	0	0	0	0	0	0	0	0	0	0	0	0	5
23:45	0	5	0	0	0	0	0	0	0	0	0	0	0	0	0	5
	0	25	4	0	1	0	0	0	0	1	0	0	0	0	0	31
Total	58	2121	295	6	32	16	1	4	7	2	0	0	0	3	0	2545
Percent	2.3%	83.3%	11.6%	0.2%	1.3%	0.6%	0.0%	0.2%	0.3%	0.1%	0.0%	0.0%	0.0%	0.1%	0.0%	

Tri-State Traffic Data, Inc

184 Baker Rd
Coatesville, PA 19320

Site Code: NY 211
Station ID: 000000000000
41.514745 -74.249629

Latitude: 0' 0.0000 Undefined

Direction 1 North

Start Time	Class 1	Class 2	Class 3	Class 4	Class 5	Class 6	Class 7	Class 8	Class 9	Class 10	Class 11	Class 12	Class 13	Class 14	Class 15	Total
06/10/1																
9	0	1	1	0	0	0	0	0	0	0	0	0	0	0	0	2
00:15	0	2	0	0	0	0	0	0	0	0	0	0	0	0	0	2
00:30	0	6	0	0	0	0	0	0	1	0	0	0	0	0	0	7
00:45	0	6	0	0	0	0	0	0	0	0	0	0	0	0	0	6
	0	15	1	0	0	0	0	0	1	0	0	0	0	0	0	17
01:00	0	6	0	0	0	0	0	0	0	0	0	0	0	0	0	6
01:15	0	3	0	0	0	0	0	0	3	0	0	0	0	0	0	6
01:30	0	3	1	0	0	0	0	0	0	0	0	0	0	0	0	4
01:45	0	2	0	0	1	0	0	0	1	0	0	0	0	0	0	4
	0	14	1	0	1	0	0	0	4	0	0	0	0	0	0	20
02:00	0	1	0	0	0	0	0	0	0	0	0	0	0	0	0	1
02:15	0	4	0	0	0	0	0	0	0	0	0	0	0	0	0	4
02:30	0	3	0	0	0	1	0	0	0	0	0	0	0	0	0	4
02:45	0	2	0	0	0	0	0	0	0	0	0	0	0	0	0	2
	0	10	0	0	0	1	0	0	0	0	0	0	0	0	0	11
03:00	0	1	0	0	0	0	0	0	1	0	0	0	0	0	0	2
03:15	0	2	0	0	1	0	0	0	0	0	0	0	0	0	0	3
03:30	0	5	0	1	0	1	0	0	0	0	0	0	0	0	0	7
03:45	0	4	1	0	0	2	0	0	0	0	0	0	0	0	0	7
	0	12	1	1	1	3	0	0	1	0	0	0	0	0	0	19
04:00	0	0	0	0	0	0	0	0	0	0	0	0	0	0	0	0
04:15	0	1	0	1	0	0	0	0	0	0	0	0	0	0	0	2
04:30	0	4	0	1	0	0	0	0	0	0	0	0	0	0	0	5
04:45	0	2	0	0	0	0	0	0	0	0	0	0	0	0	0	2
	0	7	0	2	0	0	0	0	0	0	0	0	0	0	0	9
05:00	0	2	1	2	0	0	0	0	0	0	0	0	0	0	0	5
05:15	0	4	0	0	0	0	0	0	0	0	0	0	0	0	0	4
05:30	0	2	1	1	0	0	0	0	0	0	0	0	0	0	0	4
05:45	0	9	3	0	0	0	0	0	0	0	0	0	0	0	0	12
	0	17	5	3	0	0	0	0	0	0	0	0	0	0	0	25
06:00	0	7	3	0	2	0	0	0	1	0	0	0	0	0	0	13
06:15	0	20	3	0	1	0	0	0	0	0	0	0	0	0	0	24
06:30	0	19	7	0	2	0	0	0	1	0	0	0	0	0	0	29
06:45	0	24	10	5	4	1	0	0	0	0	0	0	0	0	0	44
	0	70	23	5	9	1	0	0	2	0	0	0	0	0	0	110
07:00	0	26	5	1	1	0	0	0	1	0	0	0	0	0	0	34
07:15	0	12	3	0	0	0	0	0	2	0	0	0	0	0	0	17
07:30	*	*	*	*	*	*	*	*	*	*	*	*	*	*	*	*
07:45	*	*	*	*	*	*	*	*	*	*	*	*	*	*	*	*
	0	0	0	0	0	0	0	0	0	0	0	0	0	0	0	0
08:00	*	*	*	*	*	*	*	*	*	*	*	*	*	*	*	*
08:15	*	*	*	*	*	*	*	*	*	*	*	*	*	*	*	*
08:30	*	*	*	*	*	*	*	*	*	*	*	*	*	*	*	*
08:45	*	*	*	*	*	*	*	*	*	*	*	*	*	*	*	*
	0	0	0	0	0	0	0	0	0	0	0	0	0	0	0	0
09:00	*	*	*	*	*	*	*	*	*	*	*	*	*	*	*	*
09:15	*	*	*	*	*	*	*	*	*	*	*	*	*	*	*	*
09:30	*	*	*	*	*	*	*	*	*	*	*	*	*	*	*	*
09:45	*	*	*	*	*	*	*	*	*	*	*	*	*	*	*	*
	0	0	0	0	0	0	0	0	0	0	0	0	0	0	0	0
10:00	*	*	*	*	*	*	*	*	*	*	*	*	*	*	*	*
10:15	*	*	*	*	*	*	*	*	*	*	*	*	*	*	*	*
10:30	*	*	*	*	*	*	*	*	*	*	*	*	*	*	*	*
10:45	*	*	*	*	*	*	*	*	*	*	*	*	*	*	*	*
	0	0	0	0	0	0	0	0	0	0	0	0	0	0	0	0
11:00	*	*	*	*	*	*	*	*	*	*	*	*	*	*	*	*
11:15	*	*	*	*	*	*	*	*	*	*	*	*	*	*	*	*
11:30	*	*	*	*	*	*	*	*	*	*	*	*	*	*	*	*
11:45	*	*	*	*	*	*	*	*	*	*	*	*	*	*	*	*
Total	0	183	39	12	12	5	0	0	11	0	0	0	0	0	0	262
Percent	0.0%	69.8%	14.9%	4.6%	4.6%	1.9%	0.0%	0.0%	4.2%	0.0%	0.0%	0.0%	0.0%	0.0%	0.0%	
Grand Total	229	19132	3119	175	593	372	22	116	103	9	2	1	15	101	0	23989
Percent	1.0%	79.8%	13.0%	0.7%	2.5%	1.6%	0.1%	0.5%	0.4%	0.0%	0.0%	0.0%	0.1%	0.4%	0.0%	

Tri-State Traffic Data, Inc
 184 Baker Rd
 Coatesville, PA 19320

Site Code: NY 211
 Station ID: 00000000000
 41.514745 -74.249629

Latitude: 0' 0.0000 Undefined

Direction 2 South

Start Time	Class 1	Class 2	Class 3	Class 4	Class 5	Class 6	Class 7	Class 8	Class 9	Class 10	Class 11	Class 12	Class 13	Class 14	Class 15	Total
12 PM	*	*	*	*	*	*	*	*	*	*	*	*	*	*	*	*
12:15	*	*	*	*	*	*	*	*	*	*	*	*	*	*	*	*
12:30	*	*	*	*	*	*	*	*	*	*	*	*	*	*	*	*
12:45	*	*	*	*	*	*	*	*	*	*	*	*	*	*	*	*
13:00	0	0	0	0	0	0	0	0	0	0	0	0	0	0	0	0
13:15	*	*	*	*	*	*	*	*	*	*	*	*	*	*	*	*
13:30	*	*	*	*	*	*	*	*	*	*	*	*	*	*	*	*
13:45	*	*	*	*	*	*	*	*	*	*	*	*	*	*	*	*
14:00	0	0	0	0	0	0	0	0	0	0	0	0	0	0	0	0
14:15	*	*	*	*	*	*	*	*	*	*	*	*	*	*	*	*
14:30	*	*	*	*	*	*	*	*	*	*	*	*	*	*	*	*
14:45	*	*	*	*	*	*	*	*	*	*	*	*	*	*	*	*
15:00	0	0	0	0	0	0	0	0	0	0	0	0	0	0	0	0
15:15	*	*	*	*	*	*	*	*	*	*	*	*	*	*	*	*
15:30	*	*	*	*	*	*	*	*	*	*	*	*	*	*	*	*
15:45	*	*	*	*	*	*	*	*	*	*	*	*	*	*	*	*
16:00	0	0	0	0	0	0	0	0	0	0	0	0	0	0	0	0
16:15	*	*	*	*	*	*	*	*	*	*	*	*	*	*	*	*
16:30	*	*	*	*	*	*	*	*	*	*	*	*	*	*	*	*
16:45	*	*	*	*	*	*	*	*	*	*	*	*	*	*	*	*
17:00	0	0	0	0	0	0	0	0	0	0	0	0	0	0	0	0
17:15	*	*	*	*	*	*	*	*	*	*	*	*	*	*	*	*
17:30	*	*	*	*	*	*	*	*	*	*	*	*	*	*	*	*
17:45	*	*	*	*	*	*	*	*	*	*	*	*	*	*	*	*
18:00	0	0	0	0	0	0	0	0	0	0	0	0	0	0	0	0
18:15	*	*	*	*	*	*	*	*	*	*	*	*	*	*	*	*
18:30	*	*	*	*	*	*	*	*	*	*	*	*	*	*	*	*
18:45	*	*	*	*	*	*	*	*	*	*	*	*	*	*	*	*
19:00	0	0	0	0	0	0	0	0	0	0	0	0	0	0	0	0
19:15	*	*	*	*	*	*	*	*	*	*	*	*	*	*	*	*
19:30	*	*	*	*	*	*	*	*	*	*	*	*	*	*	*	*
19:45	*	*	*	*	*	*	*	*	*	*	*	*	*	*	*	*
20:00	0	0	0	0	0	0	0	0	0	0	0	0	0	0	0	0
20:15	0	32	3	1	1	0	0	0	0	0	0	0	0	0	0	37
20:30	0	52	4	0	0	0	0	0	0	0	0	0	0	0	0	56
20:30	0	28	6	0	0	0	0	0	0	0	0	0	0	0	0	34
20:45	0	29	6	0	2	0	0	0	0	0	0	0	0	0	0	37
21:00	0	141	19	1	3	0	0	0	0	0	0	0	0	0	0	164
21:15	0	16	3	0	1	0	0	0	0	0	0	0	0	0	0	20
21:30	0	13	2	0	1	0	0	0	0	0	0	0	0	0	0	16
21:30	0	24	1	0	0	0	0	0	0	0	0	0	0	0	0	25
21:45	0	14	3	0	2	0	0	0	0	0	0	0	0	0	0	19
22:00	0	67	9	0	4	0	0	0	0	0	0	0	0	0	0	80
22:00	0	14	0	0	0	0	0	0	2	0	0	0	0	0	0	16
22:15	0	5	1	0	0	0	0	0	0	0	0	0	0	0	0	6
22:30	0	9	4	0	2	0	0	0	1	0	0	0	0	0	0	16
22:45	0	6	0	0	1	0	0	0	0	0	0	0	0	0	0	7
23:00	0	34	5	0	3	0	0	0	3	0	0	0	0	0	0	45
23:00	0	10	2	0	0	0	0	0	0	0	0	0	0	0	0	12
23:15	0	9	1	0	0	0	0	0	0	0	0	0	0	0	0	10
23:30	0	4	1	0	0	0	0	0	0	0	0	0	0	0	0	5
23:45	0	1	1	0	1	0	0	0	0	0	0	0	0	0	0	3
Total	0	24	5	0	1	0	0	0	0	0	0	0	0	0	0	30
Percent	0.0%	83.4%	11.9%	0.3%	3.4%	0.0%	0.0%	0.0%	0.0%	0.9%	0.0%	0.0%	0.0%	0.0%	0.0%	319

Tri-State Traffic Data, Inc

184 Baker Rd
Coatesville, PA 19320

Site Code: NY 211
Station ID: 000000000000
41.514745 -74.249629

Latitude: 0' 0.0000 Undefined

Direction 2 South

Start Time	Class 1	Class 2	Class 3	Class 4	Class 5	Class 6	Class 7	Class 8	Class 9	Class 10	Class 11	Class 12	Class 13	Class 14	Class 15	Total
06/05/1																
9	0	6	0	0	0	0	0	0	0	0	0	0	0	0	0	6
00:15	0	4	1	0	0	0	0	0	0	0	0	0	0	0	0	5
00:30	0	4	0	0	0	0	0	0	1	0	0	0	0	0	0	5
00:45	0	2	0	0	0	0	0	0	1	0	1	0	0	0	0	4
	0	16	1	0	0	0	0	0	2	0	1	0	0	0	0	20
01:00	0	0	0	0	0	0	0	0	0	0	0	0	0	0	0	0
01:15	0	2	0	0	0	0	0	0	1	0	0	0	0	0	0	3
01:30	0	0	0	0	0	0	0	0	0	0	0	0	0	0	0	0
01:45	0	3	0	0	0	0	0	0	0	0	0	0	0	0	0	3
	0	5	0	0	0	0	0	0	1	0	0	0	0	0	0	6
02:00	0	2	1	0	0	0	0	0	0	0	0	0	0	0	0	3
02:15	0	3	0	0	0	0	0	0	0	0	0	0	0	0	0	3
02:30	0	4	0	0	0	0	0	0	0	0	0	0	0	0	0	4
02:45	0	4	2	0	0	0	0	0	0	0	0	0	0	0	0	6
	0	13	3	0	0	0	0	0	0	0	0	0	0	0	0	16
03:00	0	2	2	0	0	0	0	0	0	0	0	0	0	0	0	4
03:15	0	7	1	0	0	0	0	0	1	0	0	0	0	0	0	9
03:30	0	3	2	0	0	0	0	0	0	0	0	0	0	0	0	5
03:45	0	7	3	0	0	0	0	0	0	0	0	0	0	0	0	10
	0	19	8	0	0	0	0	0	1	0	0	0	0	0	0	28
04:00	0	5	3	0	0	0	0	0	0	0	0	0	0	0	0	8
04:15	0	10	1	0	0	0	0	0	0	0	0	0	0	0	0	11
04:30	0	18	4	0	1	0	0	0	0	0	0	0	0	0	0	23
04:45	0	10	2	0	2	0	0	0	0	0	0	0	0	0	0	14
	0	43	10	0	3	0	0	0	0	0	0	0	0	0	0	56
05:00	1	11	6	1	0	0	0	0	0	0	0	0	0	0	0	19
05:15	0	21	4	0	0	0	0	0	0	0	0	0	0	0	0	25
05:30	0	27	1	0	0	0	0	0	0	0	0	0	0	0	0	28
05:45	0	21	9	0	0	0	0	0	0	0	0	0	0	0	0	30
	1	80	20	1	0	0	0	0	0	0	0	0	0	0	0	102
06:00	0	35	8	0	2	0	0	0	0	0	0	0	0	0	0	45
06:15	0	45	17	0	4	1	0	0	0	0	0	0	0	0	0	67
06:30	0	59	16	0	4	0	0	0	0	0	0	0	0	0	0	79
06:45	0	67	12	1	2	0	0	0	0	0	0	0	0	0	0	82
	0	206	53	1	12	1	0	0	0	0	0	0	0	0	0	273
07:00	1	84	12	1	6	0	1	0	1	0	0	0	0	0	0	106
07:15	0	92	20	2	6	1	0	1	0	0	0	0	0	0	0	122
07:30	0	99	13	4	4	0	0	0	0	0	0	0	0	0	0	120
07:45	0	114	12	0	3	1	0	0	0	0	0	0	0	0	0	130
	1	389	57	7	19	2	1	1	1	0	0	0	0	0	0	478
08:00	0	85	14	2	2	0	1	1	0	0	0	0	0	0	0	105
08:15	0	102	19	2	4	2	1	1	0	0	0	0	0	2	0	133
08:30	1	89	20	2	5	4	0	0	1	0	0	0	0	0	0	122
08:45	0	82	11	0	0	2	0	0	0	0	0	0	0	0	0	95
	1	358	64	6	11	8	2	2	1	0	0	0	0	2	0	455
09:00	0	48	20	6	3	0	0	0	0	0	0	0	0	0	0	77
09:15	0	64	16	1	6	0	0	1	1	0	0	0	0	0	0	89
09:30	0	41	11	0	3	2	0	0	0	0	0	0	0	0	0	57
09:45	0	41	10	0	8	0	0	1	0	0	0	0	0	1	0	61
	0	194	57	7	20	2	0	2	1	0	0	0	0	1	0	284
10:00	0	43	11	1	3	0	0	1	0	0	0	0	0	0	0	59
10:15	0	39	6	1	1	0	0	0	0	0	0	0	0	0	0	47
10:30	0	45	9	1	3	0	0	1	2	0	0	0	0	1	0	62
10:45	0	48	9	1	7	2	0	3	0	0	0	0	0	0	0	70
	0	175	35	4	14	2	0	5	2	0	0	0	0	1	0	238
11:00	1	47	12	0	3	0	0	0	0	1	0	0	0	0	0	64
11:15	0	49	11	0	1	1	0	1	0	0	0	0	0	0	0	63
11:30	1	60	14	1	0	0	0	0	0	0	0	0	0	0	0	76
11:45	0	52	11	0	0	0	0	1	1	0	0	0	0	0	0	65
	2	208	48	1	4	1	0	2	1	1	0	0	0	0	0	268
Total	5	1706	356	27	83	16	3	12	10	1	1	0	0	4	0	2224
Percent	0.2%	76.7%	16.0%	1.2%	3.7%	0.7%	0.1%	0.5%	0.4%	0.0%	0.0%	0.0%	0.0%	0.2%	0.0%	

Tri-State Traffic Data, Inc

184 Baker Rd
Coatesville, PA 19320

Site Code: NY 211
Station ID: 000000000000
41.514745 -74.249629

Latitude: 0' 0.0000 Undefined

Direction 2 South

Start Time	Class 1	Class 2	Class 3	Class 4	Class 5	Class 6	Class 7	Class 8	Class 9	Class 10	Class 11	Class 12	Class 13	Class 14	Class 15	Total
12 PM	0	52	7	2	3	0	0	0	0	0	0	0	0	1	0	65
12:15	0	56	15	4	2	0	0	1	0	1	0	0	0	0	0	79
12:30	1	59	11	0	3	0	1	1	0	0	0	0	0	0	0	76
12:45	1	60	14	2	3	1	0	0	0	0	0	0	0	0	0	81
	2	227	47	8	11	1	1	2	0	1	0	0	0	1	0	301
13:00	0	46	11	3	3	1	0	1	0	0	0	0	0	0	0	65
13:15	1	59	24	0	6	0	0	0	0	0	0	0	0	0	0	90
13:30	2	41	12	2	1	0	0	0	0	0	0	0	0	0	0	58
13:45	1	51	14	0	3	0	0	0	0	0	0	0	0	0	0	69
	4	197	61	5	13	1	0	1	0	0	0	0	0	0	0	282
14:00	1	45	9	5	2	1	0	2	0	0	0	0	0	0	0	65
14:15	1	45	11	0	5	1	0	0	0	0	0	0	0	1	0	64
14:30	0	57	16	0	1	1	0	0	0	0	0	0	0	0	0	75
14:45	0	76	14	2	2	0	0	0	0	1	0	0	0	0	0	95
	2	223	50	7	10	3	0	2	0	1	0	0	0	1	0	299
15:00	1	69	12	2	3	1	0	0	0	0	0	0	0	1	0	89
15:15	0	59	13	2	2	2	0	0	0	0	0	0	0	0	0	78
15:30	0	56	11	0	5	0	0	0	0	0	0	0	0	0	0	72
15:45	0	49	10	0	4	1	0	3	0	1	0	0	0	0	0	68
	1	233	46	4	14	4	0	3	0	1	0	0	0	1	0	307
16:00	2	57	15	0	2	2	0	1	0	0	0	0	0	0	0	79
16:15	0	57	16	0	3	0	0	1	0	0	0	0	0	0	0	77
16:30	1	52	10	0	5	2	0	1	0	0	0	0	0	0	0	71
16:45	0	59	6	1	2	1	0	1	0	0	0	0	0	0	0	70
	3	225	47	1	12	5	0	4	0	0	0	0	0	0	0	297
17:00	0	51	9	0	6	0	0	2	0	0	0	0	0	0	0	68
17:15	2	48	9	0	4	0	0	1	0	0	0	0	0	0	0	64
17:30	0	55	10	1	5	0	0	0	0	0	0	0	0	0	0	71
17:45	0	48	5	0	4	0	0	0	0	0	0	0	0	0	0	57
	2	202	33	1	19	0	0	3	0	0	0	0	0	0	0	260
18:00	0	47	11	1	2	0	0	0	0	0	0	0	0	0	0	61
18:15	0	52	9	1	3	1	0	0	0	0	0	0	0	0	0	66
18:30	0	43	16	0	1	0	0	0	0	1	0	0	0	0	0	61
18:45	0	42	7	2	1	0	0	0	0	0	0	0	0	0	0	52
	0	184	43	4	7	1	0	0	0	1	0	0	0	0	0	240
19:00	0	40	8	0	1	0	0	0	0	0	0	0	0	0	0	49
19:15	0	30	5	0	1	0	0	0	0	0	0	0	1	0	0	37
19:30	0	26	5	0	0	0	0	0	0	0	0	0	0	0	0	31
19:45	0	27	1	0	0	0	0	0	0	0	0	0	0	0	0	28
	0	123	19	0	2	0	0	0	0	0	0	0	0	1	0	145
20:00	0	30	5	1	1	0	0	2	0	0	0	0	0	0	0	39
20:15	0	30	4	0	1	0	0	0	0	0	0	0	0	0	0	35
20:30	0	26	5	0	0	0	0	0	0	0	0	0	0	0	0	31
20:45	0	32	7	0	0	0	0	0	0	0	0	0	0	0	0	39
	0	118	21	1	2	0	0	2	0	0	0	0	0	0	0	144
21:00	0	15	3	0	1	0	0	0	0	0	0	0	0	0	0	19
21:15	0	21	6	0	1	0	0	0	0	0	0	0	0	0	0	28
21:30	0	9	1	0	0	0	0	1	0	0	0	0	0	0	0	11
21:45	0	7	1	0	0	0	0	0	1	0	0	0	0	0	0	9
	0	52	11	0	2	0	0	1	1	0	0	0	0	0	0	67
22:00	0	21	0	0	0	0	0	0	0	0	0	0	0	0	0	21
22:15	0	5	4	0	1	0	0	0	0	0	0	0	0	0	0	10
22:30	0	16	0	0	0	0	0	0	0	0	0	0	0	0	0	16
22:45	0	7	2	0	0	0	0	0	0	0	0	0	0	0	0	9
	0	49	6	0	1	0	0	0	0	0	0	0	0	0	0	56
23:00	0	12	0	0	0	0	0	0	0	0	0	0	0	0	0	12
23:15	0	9	1	0	1	0	0	0	1	0	0	0	0	0	0	12
23:30	0	7	2	0	0	0	0	0	0	0	0	0	0	0	0	9
23:45	0	3	0	0	0	0	0	0	0	0	0	0	0	0	0	3
	0	31	3	0	1	0	0	0	1	0	0	0	0	0	0	36
Total	14	1864	387	31	94	15	1	18	2	4	0	0	1	3	0	2434
Percent	0.6%	76.6%	15.9%	1.3%	3.9%	0.6%	0.0%	0.7%	0.1%	0.2%	0.0%	0.0%	0.0%	0.1%	0.0%	

Tri-State Traffic Data, Inc

184 Baker Rd
Coatesville, PA 19320

Site Code: NY 211
Station ID: 000000000000
41.514745 -74.249629

Latitude: 0' 0.0000 Undefined

Direction 2 South

Start Time	Class 1	Class 2	Class 3	Class 4	Class 5	Class 6	Class 7	Class 8	Class 9	Class 10	Class 11	Class 12	Class 13	Class 14	Class 15	Total
12 PM	0	46	11	1	3	0	0	1	0	0	0	0	0	0	0	62
12:15	1	56	14	1	1	0	0	1	0	0	0	0	0	0	0	74
12:30	0	64	13	1	3	0	0	0	1	0	0	0	0	0	0	82
12:45	0	49	12	2	1	2	0	1	0	0	0	0	0	0	0	67
	1	215	50	5	8	2	0	3	1	0	0	0	0	0	0	285
13:00	0	56	11	2	3	0	0	1	0	0	0	0	0	1	0	74
13:15	0	61	14	2	3	0	0	0	2	0	0	0	0	0	0	82
13:30	1	35	14	0	2	1	0	0	1	0	0	0	0	0	0	54
13:45	0	46	13	0	5	0	0	0	0	0	0	0	0	1	0	65
	1	198	52	4	13	1	0	1	3	0	0	0	0	2	0	275
14:00	0	54	12	3	2	2	0	1	1	0	0	0	0	0	0	75
14:15	1	42	6	1	2	1	0	0	0	0	0	0	0	0	0	53
14:30	1	60	11	0	4	0	0	1	0	0	0	0	0	1	0	78
14:45	2	64	14	1	6	0	0	0	0	0	0	0	0	0	0	87
	4	220	43	5	14	3	0	2	1	0	0	0	0	1	0	293
15:00	0	63	17	5	2	0	0	0	0	0	0	0	0	0	0	87
15:15	0	44	10	0	4	0	0	3	0	0	0	0	0	0	0	61
15:30	0	72	21	1	6	1	0	0	1	0	0	0	0	0	0	102
15:45	1	65	19	1	2	1	0	1	0	0	0	0	0	0	0	90
	1	244	67	7	14	2	0	4	1	0	0	0	0	0	0	340
16:00	0	65	14	1	4	0	0	0	0	0	0	0	0	0	0	84
16:15	1	52	10	0	5	0	0	0	1	0	0	0	0	0	0	69
16:30	0	55	11	0	4	0	0	0	0	0	0	0	0	0	0	70
16:45	1	58	12	1	4	1	0	0	0	0	0	0	0	0	0	77
	2	230	47	2	17	1	0	0	1	0	0	0	0	0	0	300
17:00	1	52	11	0	2	0	0	0	1	0	0	0	0	1	0	68
17:15	0	67	12	0	3	0	0	0	0	0	0	0	0	0	0	82
17:30	0	61	12	0	2	0	0	0	0	0	0	0	0	0	0	75
17:45	0	53	12	2	1	0	0	0	0	0	0	0	0	0	0	68
	1	233	47	2	8	0	0	0	1	0	0	0	0	1	0	293
18:00	0	54	9	2	2	0	0	1	1	0	0	0	0	0	0	69
18:15	0	53	7	0	0	0	0	0	0	0	0	0	0	0	0	60
18:30	1	41	7	1	1	0	0	0	0	0	0	0	0	0	0	51
18:45	2	45	12	2	3	0	0	0	0	0	0	0	0	0	0	64
	3	193	35	5	6	0	0	1	1	0	0	0	0	0	0	244
19:00	1	30	15	0	1	0	0	0	0	0	0	0	0	0	0	47
19:15	0	32	7	0	2	0	0	0	0	0	0	0	0	0	0	41
19:30	0	34	8	0	2	0	0	0	0	0	0	0	0	0	0	44
19:45	0	31	6	0	0	0	0	0	0	0	0	0	0	0	0	37
	1	127	36	0	5	0	0	0	0	0	0	0	0	0	0	169
20:00	0	31	4	1	0	0	0	0	0	0	0	0	0	0	0	36
20:15	0	32	5	1	0	0	0	0	1	0	0	0	0	0	0	39
20:30	0	23	2	0	0	0	0	0	0	0	0	0	0	0	0	25
20:45	0	28	2	0	0	0	0	0	0	0	0	0	0	0	0	30
	0	114	13	2	0	0	0	0	1	0	0	0	0	0	0	130
21:00	0	23	6	0	0	0	0	0	0	0	0	0	0	0	0	29
21:15	0	12	1	0	1	0	0	0	0	0	0	0	0	0	0	14
21:30	0	17	2	0	0	0	0	0	0	0	0	0	0	0	0	19
21:45	0	14	2	0	0	0	0	0	0	0	0	0	0	0	0	16
	0	66	11	0	1	0	0	0	0	0	0	0	0	0	0	78
22:00	0	13	0	0	0	0	0	0	0	0	0	0	0	0	0	13
22:15	0	7	2	0	0	0	0	0	0	0	0	0	0	0	0	9
22:30	1	10	1	0	0	0	0	0	0	0	0	0	0	0	0	12
22:45	0	8	3	0	0	0	0	0	0	0	0	0	0	0	0	11
	1	38	6	0	0	0	0	0	0	0	0	0	0	0	0	45
23:00	0	4	1	0	0	0	0	0	0	0	0	0	0	0	0	5
23:15	0	8	1	0	0	0	0	0	0	0	0	0	0	0	0	9
23:30	0	8	0	0	1	0	0	0	0	0	0	0	0	0	0	9
23:45	0	6	1	0	0	0	0	0	0	0	0	0	0	0	0	7
	0	26	3	0	1	0	0	0	0	0	0	0	0	0	0	30
Total	15	1904	410	32	87	9	0	11	10	0	0	0	0	4	0	2482
Percent	0.6%	76.7%	16.5%	1.3%	3.5%	0.4%	0.0%	0.4%	0.4%	0.0%	0.0%	0.0%	0.0%	0.2%	0.0%	

Tri-State Traffic Data, Inc

184 Baker Rd
Coatesville, PA 19320

Site Code: NY 211
Station ID: 000000000000
41.514745 -74.249629

Latitude: 0' 0.0000 Undefined

Direction 2 South

Start Time	Class 1	Class 2	Class 3	Class 4	Class 5	Class 6	Class 7	Class 8	Class 9	Class 10	Class 11	Class 12	Class 13	Class 14	Class 15	Total
06/07/1																
9	0	6	1	0	0	0	0	0	0	0	0	0	0	0	0	7
00:15	0	2	2	0	0	0	0	0	0	0	0	0	0	0	0	4
00:30	0	1	0	0	0	0	0	0	1	0	0	0	0	0	0	2
00:45	0	4	1	0	0	0	0	0	0	0	0	0	0	0	0	5
	0	13	4	0	0	0	0	0	1	0	0	0	0	0	0	18
01:00	0	1	0	0	0	0	0	0	0	0	0	0	0	0	0	1
01:15	0	2	0	0	0	0	0	0	1	0	0	0	0	0	0	3
01:30	0	1	0	0	0	0	0	0	0	0	0	0	0	0	0	1
01:45	0	2	0	0	0	0	0	0	0	0	0	0	0	0	0	2
	0	6	0	0	0	0	0	0	1	0	0	0	0	0	0	7
02:00	0	1	2	0	0	0	0	0	0	0	0	0	0	0	0	3
02:15	0	2	0	0	0	0	0	0	0	0	0	0	0	0	0	2
02:30	0	1	0	0	0	0	0	0	0	0	0	0	0	0	0	1
02:45	0	2	1	0	0	0	0	0	1	0	0	0	0	0	0	4
	0	6	3	0	0	0	0	0	1	0	0	0	0	0	0	10
03:00	0	4	1	0	0	0	0	0	0	0	0	0	0	0	0	5
03:15	0	5	4	0	0	0	0	0	1	0	0	0	0	0	0	10
03:30	0	3	3	0	0	0	0	0	1	0	0	0	0	0	0	7
03:45	0	4	4	0	0	0	0	0	1	0	0	0	0	0	0	9
	0	16	12	0	0	0	0	0	3	0	0	0	0	0	0	31
04:00	0	7	3	0	0	0	0	0	0	0	0	0	0	0	0	10
04:15	0	6	1	0	1	0	0	0	1	0	0	0	0	0	0	9
04:30	0	11	4	0	0	0	0	0	1	0	0	0	0	0	0	16
04:45	0	9	1	0	2	0	0	0	0	0	0	0	0	0	0	12
	0	33	9	0	3	0	0	0	2	0	0	0	0	0	0	47
05:00	2	15	0	0	2	0	0	0	0	0	0	0	0	0	0	19
05:15	0	25	6	0	1	0	0	0	0	0	0	0	0	0	0	32
05:30	0	17	7	1	1	0	0	0	0	0	0	0	0	0	0	26
05:45	1	19	9	0	0	1	0	0	0	0	0	0	0	0	0	30
	3	76	22	1	4	1	0	0	0	0	0	0	0	0	0	107
06:00	1	26	5	0	4	0	0	0	0	0	0	0	0	0	0	36
06:15	0	45	15	0	4	0	0	0	1	0	0	0	0	0	0	65
06:30	1	61	12	0	8	0	0	0	0	0	0	0	0	0	0	82
06:45	1	58	23	0	4	0	0	0	1	0	0	0	0	0	0	87
	3	190	55	0	20	0	0	0	2	0	0	0	0	0	0	270
07:00	1	53	14	1	4	0	0	0	0	0	0	0	0	1	0	74
07:15	0	79	16	2	6	0	0	2	0	0	0	0	0	0	0	105
07:30	0	85	12	2	5	0	0	0	0	0	0	0	0	0	0	104
07:45	0	80	15	0	4	0	0	0	1	0	0	0	0	0	0	100
	1	297	57	5	19	0	0	2	1	0	0	0	0	1	0	383
08:00	1	83	16	2	3	1	1	1	0	0	0	0	0	0	0	108
08:15	0	83	17	2	2	1	0	0	0	0	0	0	0	0	0	105
08:30	0	89	12	2	5	1	0	0	0	0	0	0	0	0	0	109
08:45	1	98	16	2	3	1	0	1	0	0	0	0	1	0	0	123
	2	353	61	8	13	4	1	2	0	0	0	0	1	0	0	445
09:00	1	60	17	3	6	0	0	0	0	0	0	0	0	1	0	88
09:15	0	73	15	3	3	0	0	2	0	1	0	0	0	0	0	97
09:30	0	55	16	0	2	0	1	3	0	0	0	0	0	0	0	77
09:45	1	54	19	3	4	0	0	0	0	0	0	0	0	0	0	81
	2	242	67	9	15	0	1	5	0	1	0	0	0	1	0	343
10:00	0	61	11	1	7	0	1	0	1	0	0	0	0	2	0	84
10:15	1	42	8	1	5	0	0	2	0	0	0	0	0	0	0	59
10:30	1	52	7	2	4	0	0	2	0	0	0	0	0	0	0	68
10:45	0	51	10	1	4	0	0	2	2	0	0	0	0	0	0	70
	2	206	36	5	20	0	1	6	3	0	0	0	0	2	0	281
11:00	0	39	10	0	4	1	0	0	0	0	0	0	0	0	0	54
11:15	1	42	11	1	5	0	0	1	1	0	0	0	0	0	0	62
11:30	0	44	9	1	2	1	0	1	1	0	0	0	0	0	0	59
11:45	0	54	6	0	3	1	1	0	0	0	0	0	0	0	0	65
	1	179	36	2	14	3	1	2	2	0	0	0	0	0	0	240
Total	14	1617	362	30	108	8	4	17	16	1	0	0	1	4	0	2182
Percent	0.6%	74.1%	16.6%	1.4%	4.9%	0.4%	0.2%	0.8%	0.7%	0.0%	0.0%	0.0%	0.0%	0.2%	0.0%	

Tri-State Traffic Data, Inc

184 Baker Rd
Coatesville, PA 19320

Site Code: NY 211
Station ID: 000000000000
41.514745 -74.249629

Latitude: 0' 0.0000 Undefined

Direction 2 South

Start Time	Class 1	Class 2	Class 3	Class 4	Class 5	Class 6	Class 7	Class 8	Class 9	Class 10	Class 11	Class 12	Class 13	Class 14	Class 15	Total
12 PM	0	68	10	2	4	1	0	0	0	0	0	0	0	0	0	85
12:15	0	67	17	0	3	0	0	1	0	0	0	0	0	0	0	88
12:30	3	47	14	3	3	2	0	1	1	0	0	0	0	0	0	74
12:45	0	59	11	0	4	1	0	0	0	0	0	0	0	0	0	75
13:00	3	241	52	5	14	4	0	2	1	0	0	0	0	0	0	322
13:15	0	44	11	2	6	0	0	1	2	0	0	0	0	0	0	66
13:30	1	49	10	2	2	0	0	1	0	0	0	0	0	0	0	65
13:45	1	51	13	2	1	1	0	2	0	0	0	0	0	0	0	71
14:00	1	57	11	0	4	0	0	0	0	0	0	0	0	0	0	73
14:15	3	201	45	6	13	1	0	4	2	0	0	0	0	0	0	275
14:30	1	68	12	3	4	0	0	0	1	0	0	0	0	0	0	89
14:45	0	58	12	0	2	0	0	0	1	0	0	0	0	1	0	74
15:00	4	70	11	1	3	0	0	1	0	0	0	0	0	0	0	90
15:15	3	58	10	1	3	0	0	1	0	0	0	0	0	0	0	76
15:30	8	254	45	5	12	0	0	2	2	0	0	0	0	1	0	329
15:45	1	71	9	1	4	0	0	2	0	0	0	0	0	0	0	88
16:00	2	70	12	1	6	0	0	0	0	0	0	0	0	0	0	91
16:15	0	76	17	2	2	0	0	0	0	0	0	0	0	0	0	97
16:30	1	59	16	1	4	1	0	1	1	0	0	0	0	1	0	85
16:45	4	276	54	5	16	1	0	3	1	0	0	0	0	1	0	361
17:00	0	76	13	0	2	0	0	0	0	0	0	0	0	0	0	91
17:15	0	61	9	2	2	0	0	1	0	0	0	0	1	1	0	77
17:30	1	67	16	1	1	0	0	0	0	0	0	0	0	0	0	86
17:45	1	56	6	1	4	0	0	0	0	0	0	0	0	1	0	69
18:00	2	260	44	4	9	0	0	1	0	0	0	0	1	2	0	323
18:15	4	73	4	0	1	0	0	0	0	0	0	0	0	1	0	83
18:30	1	55	9	1	2	0	0	0	0	0	0	0	0	0	0	68
18:45	1	63	12	2	2	0	0	0	0	0	0	0	0	0	0	80
19:00	0	58	13	0	1	0	0	0	0	0	0	0	0	0	0	72
19:15	6	249	38	3	6	0	0	0	0	0	0	0	0	1	0	303
19:30	1	48	11	2	1	0	0	0	0	0	0	0	0	0	0	63
19:45	0	68	13	0	1	0	0	2	0	0	0	0	0	0	0	84
20:00	0	55	9	0	1	0	0	0	0	0	0	0	0	0	0	65
20:15	1	53	12	1	0	0	0	0	1	0	0	0	0	0	0	68
20:30	2	224	45	3	3	0	0	2	1	0	0	0	0	0	0	280
20:45	0	53	6	2	0	0	0	0	0	0	0	0	0	0	0	61
21:00	0	32	5	2	0	0	0	0	0	0	0	0	0	0	0	39
21:15	0	43	5	0	3	0	1	0	0	0	0	0	0	0	0	52
21:30	2	38	7	0	1	0	0	0	0	0	0	0	0	0	0	48
21:45	2	166	23	4	4	0	1	0	0	0	0	0	0	0	0	200
22:00	1	34	4	1	0	0	0	0	0	0	0	0	0	0	0	40
22:15	0	37	5	0	2	0	0	0	0	0	0	0	0	0	0	44
22:30	0	17	3	0	1	0	0	0	0	0	0	0	0	0	0	21
22:45	0	27	4	0	0	0	0	1	0	0	0	0	0	0	0	32
23:00	1	115	16	1	3	0	0	1	0	0	0	0	0	0	0	137
23:15	0	14	6	0	0	0	0	0	0	0	0	0	0	0	0	20
23:30	0	23	3	0	2	0	0	0	0	0	0	0	0	0	0	28
23:45	0	31	3	0	0	0	0	0	0	0	0	0	0	0	0	34
24:00	0	20	4	0	0	0	0	0	0	0	0	0	0	0	0	24
24:15	0	88	16	0	2	0	0	0	0	0	0	0	0	0	0	106
24:30	0	17	3	0	3	0	0	0	0	0	0	0	0	0	0	23
24:45	1	25	2	0	0	0	0	0	0	0	0	0	0	0	0	28
25:00	1	27	5	0	0	0	0	0	0	0	0	0	0	0	0	33
25:15	2	16	2	0	0	0	0	0	0	0	0	0	0	0	0	20
25:30	4	85	12	0	3	0	0	0	0	0	0	0	0	0	0	104
25:45	0	16	1	0	0	0	0	0	1	0	0	0	0	0	0	18
26:00	0	9	1	0	0	0	0	0	0	0	0	0	0	0	0	10
26:15	0	6	1	0	0	0	0	0	0	0	0	0	0	0	0	7
26:30	0	8	1	0	0	0	0	0	0	0	0	0	0	0	0	9
26:45	0	39	4	0	0	0	0	0	1	0	0	0	0	0	0	44
Total	35	2198	394	36	85	6	1	15	8	0	0	0	1	5	0	2784
Percent	1.3%	79.0%	14.2%	1.3%	3.1%	0.2%	0.0%	0.5%	0.3%	0.0%	0.0%	0.0%	0.0%	0.2%	0.0%	

Tri-State Traffic Data, Inc

184 Baker Rd
Coatesville, PA 19320

Site Code: NY 211
Station ID: 000000000000
41.514745 -74.249629

Latitude: 0' 0.0000 Undefined

Direction 2 South

Start Time	Class 1	Class 2	Class 3	Class 4	Class 5	Class 6	Class 7	Class 8	Class 9	Class 10	Class 11	Class 12	Class 13	Class 14	Class 15	Total
06/08/1																
9	0	8	1	0	0	0	0	0	0	0	0	0	0	0	0	9
00:15	0	8	2	0	0	0	0	1	0	0	0	0	0	0	0	11
00:30	0	5	1	0	0	0	0	0	0	0	0	0	0	0	0	6
00:45	0	2	0	0	0	0	0	0	0	0	0	0	0	0	0	2
	0	23	4	0	0	0	0	1	0	0	0	0	0	0	0	28
01:00	0	7	0	0	0	0	0	0	0	0	0	0	0	0	0	7
01:15	0	3	0	0	0	0	0	0	0	0	0	0	0	0	0	3
01:30	0	1	1	0	0	0	0	0	1	0	0	0	0	0	0	3
01:45	0	2	0	0	0	0	0	0	0	0	0	0	0	0	0	2
	0	13	1	0	0	0	0	0	1	0	0	0	0	0	0	15
02:00	0	2	1	0	0	0	0	0	0	0	0	0	0	0	0	3
02:15	0	2	0	0	0	0	0	0	0	0	0	0	0	0	0	2
02:30	0	1	2	0	0	0	0	0	0	0	0	0	0	0	0	3
02:45	0	5	0	0	0	0	0	0	0	0	0	0	0	0	0	5
	0	10	3	0	0	0	0	0	0	0	0	0	0	0	0	13
03:00	0	1	1	0	1	0	0	0	0	0	0	0	0	0	0	3
03:15	0	5	0	0	0	0	0	0	0	0	0	0	0	0	0	5
03:30	0	3	3	0	0	0	0	0	0	0	0	0	0	0	0	6
03:45	0	1	1	0	0	0	0	0	0	0	0	0	0	0	0	2
	0	10	5	0	1	0	0	0	0	0	0	0	0	0	0	16
04:00	0	2	0	0	0	0	0	0	0	0	0	0	0	0	0	2
04:15	0	1	1	1	0	0	0	0	0	0	0	0	0	0	0	3
04:30	0	4	0	0	2	0	0	0	0	0	0	0	0	0	0	6
04:45	0	5	2	0	0	0	0	0	0	0	0	0	0	0	0	7
	0	12	3	1	2	0	0	0	0	0	0	0	0	0	0	18
05:00	0	2	2	0	0	0	0	0	0	0	0	0	0	0	0	4
05:15	0	10	3	0	1	0	0	0	0	0	0	0	0	0	0	14
05:30	0	9	0	0	0	0	0	0	0	0	0	0	0	0	0	9
05:45	0	8	1	0	0	0	0	0	0	0	0	0	0	0	0	9
	0	29	6	0	1	0	0	0	0	0	0	0	0	0	0	36
06:00	0	10	3	0	0	0	0	0	0	0	0	0	0	0	0	13
06:15	0	15	3	0	3	0	0	0	0	0	0	0	0	0	0	21
06:30	0	22	9	0	5	0	0	1	0	0	0	0	0	0	0	37
06:45	0	19	7	0	2	0	0	1	0	0	0	0	0	0	0	29
	0	66	22	0	10	0	0	2	0	0	0	0	0	0	0	100
07:00	0	13	2	0	4	0	0	2	0	0	0	0	0	0	0	21
07:15	1	20	5	0	3	0	0	0	0	0	0	0	0	0	0	29
07:30	0	42	14	1	2	1	0	0	0	0	0	0	0	0	0	60
07:45	2	47	13	1	1	0	0	1	0	0	0	0	0	0	0	65
	3	122	34	2	10	1	0	3	0	0	0	0	0	0	0	175
08:00	0	35	7	0	2	0	1	5	0	0	0	0	0	0	0	50
08:15	1	50	7	2	1	1	0	1	0	0	0	0	0	0	0	63
08:30	0	48	15	0	3	0	0	0	0	0	0	0	0	0	0	66
08:45	0	63	13	0	1	0	0	0	0	0	0	0	0	0	0	77
	1	196	42	2	7	1	1	6	0	0	0	0	0	0	0	256
09:00	0	50	19	0	2	1	0	2	1	0	0	0	0	0	0	75
09:15	0	74	18	0	4	2	0	0	1	0	0	0	0	0	0	99
09:30	1	51	13	2	4	1	0	1	0	0	0	0	0	0	0	73
09:45	2	55	8	0	2	0	0	2	0	0	0	0	0	0	0	69
	3	230	58	2	12	4	0	5	2	0	0	0	0	0	0	316
10:00	0	62	15	0	5	0	0	0	0	0	0	0	0	0	0	82
10:15	1	69	10	1	1	0	0	1	0	0	0	0	0	0	0	83
10:30	1	57	18	0	4	3	0	0	0	0	0	0	0	0	0	83
10:45	0	70	10	0	1	1	0	0	0	0	0	0	0	0	0	82
	2	258	53	1	11	4	0	1	0	0	0	0	0	0	0	330
11:00	1	55	16	0	4	1	0	2	1	0	0	0	1	0	0	81
11:15	0	68	14	0	4	1	1	0	0	0	0	0	0	0	0	88
11:30	1	71	10	0	2	2	0	0	1	0	0	0	0	0	0	87
11:45	2	47	14	1	2	0	1	0	0	0	0	0	0	0	0	67
	4	241	54	1	12	4	2	2	2	0	0	0	1	0	0	323
Total	13	1210	285	9	66	14	3	20	5	0	0	0	1	0	0	1626
Percent	0.8%	74.4%	17.5%	0.6%	4.1%	0.9%	0.2%	1.2%	0.3%	0.0%	0.0%	0.0%	0.1%	0.0%	0.0%	

Tri-State Traffic Data, Inc
 184 Baker Rd
 Coatesville, PA 19320

Site Code: NY 211
 Station ID: 000000000000
 41.514745 -74.249629

Latitude: 0' 0.0000 Undefined

Direction 2 South

Start Time	Class 1	Class 2	Class 3	Class 4	Class 5	Class 6	Class 7	Class 8	Class 9	Class 10	Class 11	Class 12	Class 13	Class 14	Class 15	Total
12 PM	0	73	18	0	1	0	0	1	1	0	0	0	0	0	0	94
12:15	4	63	11	0	2	0	0	0	0	0	0	0	0	0	0	80
12:30	0	75	9	0	1	1	0	1	0	0	0	0	0	0	0	87
12:45	1	80	11	0	1	0	0	1	1	0	0	0	0	0	0	95
	5	291	49	0	5	1	0	3	2	0	0	0	0	0	0	356
13:00	1	63	15	0	2	0	0	0	0	0	0	0	0	0	0	81
13:15	1	61	12	1	3	1	0	1	0	0	0	0	0	0	0	80
13:30	2	55	12	0	1	0	0	0	0	0	0	0	0	0	0	70
13:45	0	52	10	0	2	0	0	1	1	0	0	0	0	1	0	67
	4	231	49	1	8	1	0	2	1	0	0	0	0	1	0	298
14:00	1	63	10	0	2	0	0	2	1	0	0	0	0	0	0	79
14:15	0	54	10	0	2	0	0	0	0	0	0	0	0	0	0	66
14:30	0	50	9	0	2	0	0	0	0	0	0	0	0	0	0	61
14:45	2	47	11	0	1	0	0	0	1	0	0	0	0	0	0	62
	3	214	40	0	7	0	0	2	2	0	0	0	0	0	0	268
15:00	0	48	8	0	1	0	0	1	0	0	0	0	0	1	0	59
15:15	0	56	11	1	1	0	0	0	1	0	0	0	0	1	0	71
15:30	1	55	14	0	5	0	0	0	0	0	0	0	0	0	0	75
15:45	0	40	8	0	2	0	0	0	0	0	0	0	0	0	0	50
	1	199	41	1	9	0	0	1	1	0	0	0	0	2	0	255
16:00	0	49	7	0	1	0	1	0	0	0	0	0	0	0	0	58
16:15	3	49	12	0	4	0	0	0	0	0	0	0	0	0	0	68
16:30	2	52	10	0	2	0	0	1	0	0	0	0	0	0	0	67
16:45	0	65	16	0	1	0	0	0	1	0	0	0	0	0	0	83
	5	215	45	0	8	0	1	1	1	0	0	0	0	0	0	276
17:00	3	58	14	0	0	0	0	0	0	0	0	0	0	0	0	75
17:15	2	44	6	0	2	0	0	0	0	0	0	0	0	0	0	54
17:30	1	54	4	0	0	0	0	0	0	0	0	0	0	0	0	59
17:45	0	44	2	0	1	0	0	0	0	0	0	0	0	0	0	47
	6	200	26	0	3	0	0	0	0	0	0	0	0	0	0	235
18:00	0	36	8	1	0	0	0	0	1	0	0	0	0	0	0	46
18:15	2	42	5	0	1	0	0	0	0	0	0	0	0	0	0	50
18:30	1	34	8	0	1	0	0	0	1	0	0	0	0	0	0	45
18:45	0	44	10	1	1	0	0	0	0	0	0	0	0	0	0	56
	3	156	31	2	3	0	0	0	2	0	0	0	0	0	0	197
19:00	2	40	9	0	0	0	0	0	0	0	0	0	0	0	0	51
19:15	0	37	6	0	0	0	0	0	0	0	0	0	0	0	0	43
19:30	0	24	12	0	0	0	0	0	0	0	0	0	0	0	0	36
19:45	2	31	6	0	1	0	0	0	0	0	0	0	0	0	0	40
	4	132	33	0	1	0	0	0	0	0	0	0	0	0	0	170
20:00	0	23	2	0	0	0	0	0	0	0	0	0	0	0	0	25
20:15	0	29	5	0	0	0	0	0	0	0	0	0	0	0	0	34
20:30	0	29	6	0	2	0	0	0	0	0	0	0	0	0	0	37
20:45	0	24	3	0	0	1	0	0	0	0	0	0	0	0	0	28
	0	105	16	0	2	1	0	0	0	0	0	0	0	0	0	124
21:00	1	22	3	0	0	0	0	0	0	0	0	0	0	0	0	26
21:15	0	29	0	0	0	0	0	1	0	0	0	0	0	0	0	30
21:30	1	18	2	0	1	0	0	0	0	0	0	0	0	0	0	22
21:45	0	14	3	0	0	0	0	0	0	0	0	0	0	0	0	17
	2	83	8	0	1	0	0	1	0	0	0	0	0	0	0	95
22:00	0	20	3	0	0	0	0	0	0	0	0	0	0	0	0	23
22:15	0	17	1	0	0	0	0	0	0	0	0	0	0	0	0	18
22:30	0	11	3	0	0	0	0	0	0	0	0	0	0	0	0	14
22:45	0	11	3	0	0	0	0	1	0	0	0	0	0	0	0	15
	0	59	10	0	0	0	0	1	0	0	0	0	0	0	0	70
23:00	0	15	0	0	0	0	0	0	0	0	0	0	0	0	0	15
23:15	0	12	0	0	2	0	0	0	0	0	0	0	0	0	0	14
23:30	0	9	0	0	0	0	0	0	0	0	0	0	0	0	0	9
23:45	0	7	2	0	0	0	0	0	0	0	0	0	0	0	0	9
	0	43	2	0	2	0	0	0	0	0	0	0	0	0	0	47
Total	33	1928	350	4	49	3	1	11	9	0	0	0	0	3	0	2391
Percent	1.4%	80.6%	14.6%	0.2%	2.0%	0.1%	0.0%	0.5%	0.4%	0.0%	0.0%	0.0%	0.0%	0.1%	0.0%	

Tri-State Traffic Data, Inc

184 Baker Rd
Coatesville, PA 19320

Site Code: NY 211
Station ID: 000000000000
41.514745 -74.249629

Latitude: 0' 0.0000 Undefined

Direction 2 South

Start Time	Class 1	Class 2	Class 3	Class 4	Class 5	Class 6	Class 7	Class 8	Class 9	Class 10	Class 11	Class 12	Class 13	Class 14	Class 15	Total
06/09/1																
9	0	7	0	0	0	0	0	0	0	0	0	0	0	0	0	7
00:15	0	3	0	0	0	0	0	0	0	0	0	0	0	0	0	3
00:30	0	3	0	0	0	0	0	0	0	0	0	0	0	0	0	3
00:45	0	7	1	0	0	0	0	0	0	0	0	0	0	0	0	8
	0	20	1	0	0	0	0	0	0	0	0	0	0	0	0	21
01:00	0	4	0	0	0	0	0	0	0	0	0	0	0	0	0	4
01:15	0	7	0	0	0	0	0	0	0	0	0	0	0	0	0	7
01:30	0	3	0	0	0	0	0	0	0	0	0	0	0	0	0	3
01:45	0	1	3	0	0	0	0	0	0	0	0	0	0	0	0	4
	0	15	3	0	0	0	0	0	0	0	0	0	0	0	0	18
02:00	0	0	0	0	0	0	0	0	0	0	0	0	0	0	0	0
02:15	0	1	0	0	0	0	0	0	0	0	0	0	0	0	0	1
02:30	0	2	0	0	0	0	0	0	0	0	0	0	0	0	0	2
02:45	0	1	1	0	0	0	0	0	0	0	0	0	0	0	0	2
	0	4	1	0	0	0	0	0	0	0	0	0	0	0	0	5
03:00	0	0	0	0	0	0	0	0	0	0	0	0	0	0	0	0
03:15	0	3	0	0	0	0	0	0	0	0	0	0	0	0	0	3
03:30	0	1	0	0	0	0	0	0	0	0	0	0	0	0	0	1
03:45	0	0	0	0	0	0	0	0	0	0	0	0	0	0	0	0
	0	4	0	0	0	0	0	0	0	0	0	0	0	0	0	4
04:00	0	1	0	0	0	0	0	0	0	0	0	0	0	0	0	1
04:15	0	2	0	0	0	0	0	0	0	0	0	0	0	0	0	2
04:30	0	2	0	0	0	0	0	0	0	0	0	0	0	0	0	2
04:45	0	2	1	0	0	0	0	0	0	0	0	0	0	0	0	3
	0	7	1	0	0	0	0	0	0	0	0	0	0	0	0	8
05:00	0	4	2	1	0	0	0	0	0	0	0	0	0	0	0	7
05:15	1	1	3	0	0	0	0	0	0	0	0	0	0	0	0	5
05:30	0	7	0	0	0	0	0	0	0	0	0	0	0	0	0	7
05:45	0	6	0	0	1	0	0	0	0	0	0	0	0	0	0	7
	1	18	5	1	1	0	0	0	0	0	0	0	0	0	0	26
06:00	0	9	1	0	1	0	0	0	0	0	0	0	0	0	0	11
06:15	0	9	5	0	2	0	0	0	0	0	0	0	0	0	0	16
06:30	0	21	1	0	0	0	0	0	0	0	0	0	0	0	0	22
06:45	0	12	6	0	1	0	0	0	0	0	0	0	0	0	0	19
	0	51	13	0	4	0	0	0	0	0	0	0	0	0	0	68
07:00	0	18	6	0	0	0	0	0	0	0	0	0	0	0	0	24
07:15	0	17	4	0	0	0	0	0	0	0	0	0	0	0	0	21
07:30	0	14	8	0	0	0	0	0	0	0	0	0	0	0	0	22
07:45	0	13	7	0	0	0	0	1	0	0	0	0	0	0	0	21
	0	62	25	0	0	0	0	1	0	0	0	0	0	0	0	88
08:00	0	19	3	0	0	0	0	2	0	0	0	0	0	0	0	24
08:15	0	30	5	0	1	0	0	1	0	0	0	0	0	0	0	37
08:30	1	35	6	0	2	0	0	0	0	0	0	0	0	0	0	44
08:45	0	25	10	0	0	0	0	1	0	0	0	0	0	0	0	36
	1	109	24	0	3	0	0	4	0	0	0	0	0	0	0	141
09:00	0	33	16	0	1	0	0	0	0	0	0	0	0	0	0	50
09:15	0	30	8	0	2	0	0	0	0	0	0	0	0	0	0	40
09:30	0	54	15	0	0	1	0	0	0	0	0	0	0	0	0	70
09:45	1	28	10	1	1	0	0	0	0	0	0	0	0	0	0	41
	1	145	49	1	4	1	0	0	0	0	0	0	0	0	0	201
10:00	1	40	6	0	2	0	0	0	0	0	0	0	0	0	0	49
10:15	0	42	9	0	1	1	0	1	0	0	0	0	0	0	0	54
10:30	0	56	8	1	1	0	0	0	0	0	0	0	0	0	0	66
10:45	0	56	14	0	3	0	0	0	0	0	0	0	0	0	0	73
	1	194	37	1	7	1	0	1	0	0	0	0	0	0	0	242
11:00	1	46	12	0	2	0	0	0	0	0	0	0	0	0	0	61
11:15	3	49	8	0	0	0	0	0	0	0	0	0	0	0	0	60
11:30	1	55	15	0	2	0	0	0	0	0	0	0	0	0	0	73
11:45	0	63	11	0	3	0	0	3	0	0	0	0	0	1	0	81
	5	213	46	0	7	0	0	3	0	0	0	0	0	1	0	275
Total	9	842	205	3	26	2	0	9	0	0	0	0	0	1	0	1097
Percent	0.8%	76.8%	18.7%	0.3%	2.4%	0.2%	0.0%	0.8%	0.0%	0.0%	0.0%	0.0%	0.0%	0.1%	0.0%	

Tri-State Traffic Data, Inc

184 Baker Rd
Coatesville, PA 19320

Site Code: NY 211
Station ID: 000000000000
41.514745 -74.249629

Latitude: 0' 0.0000 Undefined

Direction 2 South

Start Time	Class 1	Class 2	Class 3	Class 4	Class 5	Class 6	Class 7	Class 8	Class 9	Class 10	Class 11	Class 12	Class 13	Class 14	Class 15	Total
12 PM	1	55	5	0	0	0	0	0	0	0	0	0	0	0	0	61
12:15	3	64	11	0	1	0	0	0	0	0	0	0	0	0	0	79
12:30	0	76	5	0	1	0	0	0	0	0	0	0	0	0	0	82
12:45	3	64	7	0	2	0	0	1	0	0	0	0	0	0	0	77
	7	259	28	0	4	0	0	1	0	0	0	0	0	0	0	299
13:00	0	78	16	1	1	0	0	1	0	0	0	0	0	0	0	97
13:15	1	66	12	1	2	0	0	0	0	0	0	0	0	0	0	82
13:30	1	48	14	0	1	0	0	0	0	0	0	0	0	0	0	64
13:45	4	54	7	0	2	1	0	1	0	0	0	0	0	1	0	70
	6	246	49	2	6	1	0	2	0	0	0	0	0	1	0	313
14:00	6	53	5	0	0	0	0	0	0	0	0	0	0	1	0	65
14:15	3	76	9	1	1	0	0	1	0	0	0	0	0	0	0	91
14:30	1	50	9	0	0	0	0	0	1	0	0	0	0	0	0	61
14:45	1	47	8	0	0	0	0	0	0	0	0	0	0	0	0	56
	11	226	31	1	1	0	0	1	1	0	0	0	0	1	0	273
15:00	4	49	8	0	0	0	0	0	1	0	0	0	0	0	0	62
15:15	2	44	9	1	1	0	0	0	0	0	0	0	0	0	0	57
15:30	1	37	10	0	1	0	0	0	0	0	0	0	0	0	0	49
15:45	2	58	11	0	2	0	0	2	0	0	0	0	0	2	0	77
	9	188	38	1	4	0	0	2	1	0	0	0	0	2	0	245
16:00	3	55	7	0	2	0	0	1	1	0	0	0	0	2	0	71
16:15	3	39	11	0	1	0	0	0	0	0	0	0	0	2	0	56
16:30	1	30	6	0	1	0	0	0	1	0	0	0	0	0	0	39
16:45	1	42	7	0	1	0	0	0	0	0	0	0	0	0	0	51
	8	166	31	0	5	0	0	1	2	0	0	0	0	4	0	217
17:00	0	51	11	0	1	0	0	0	1	0	0	0	0	0	0	64
17:15	0	33	11	0	3	0	0	0	0	0	0	0	0	0	0	47
17:30	1	37	12	0	0	0	0	1	0	0	0	0	0	0	0	51
17:45	1	27	13	0	0	0	0	0	0	0	0	0	0	0	0	41
	2	148	47	0	4	0	0	1	1	0	0	0	0	0	0	203
18:00	2	36	4	1	1	0	0	0	0	0	0	0	0	0	0	44
18:15	3	34	3	0	1	0	0	0	1	0	0	0	0	0	0	42
18:30	1	33	8	1	0	0	0	0	0	0	0	0	0	0	0	43
18:45	0	28	4	0	0	0	0	0	0	0	0	0	0	0	0	32
	6	131	19	2	2	0	0	0	1	0	0	0	0	0	0	161
19:00	2	32	4	0	0	0	0	0	0	0	0	0	0	0	0	38
19:15	0	28	6	0	0	0	0	0	0	0	0	0	0	0	0	34
19:30	0	19	2	0	0	0	0	0	0	0	0	0	0	0	0	21
19:45	1	28	2	0	1	0	0	0	2	0	0	0	0	0	0	34
	3	107	14	0	1	0	0	0	2	0	0	0	0	0	0	127
20:00	2	18	6	0	2	0	0	0	0	0	0	0	0	0	0	28
20:15	0	23	2	0	0	0	0	0	0	0	0	0	0	0	0	25
20:30	1	23	3	0	1	0	0	0	0	0	0	0	0	0	0	28
20:45	2	22	2	0	0	0	0	0	0	0	0	0	0	0	0	26
	5	86	13	0	3	0	0	0	0	0	0	0	0	0	0	107
21:00	1	15	3	1	2	0	0	0	0	0	0	0	0	0	0	22
21:15	0	13	2	0	0	0	0	0	0	0	0	0	0	0	0	15
21:30	0	10	2	0	0	0	0	0	0	0	0	0	0	0	0	12
21:45	0	7	3	0	0	0	0	0	0	1	0	0	0	0	0	11
	1	45	10	1	2	0	0	0	0	1	0	0	0	0	0	60
22:00	0	10	1	0	1	0	0	0	0	0	0	0	0	0	0	12
22:15	0	10	6	0	0	0	0	0	0	0	0	0	0	0	0	16
22:30	0	7	2	0	0	0	0	0	0	0	0	0	0	0	0	9
22:45	0	6	1	0	0	0	0	0	0	0	0	0	0	0	0	7
	0	33	10	0	1	0	0	0	0	0	0	0	0	0	0	44
23:00	0	11	0	0	1	0	0	0	0	0	0	0	0	0	0	12
23:15	0	4	0	0	1	1	0	0	0	0	0	0	0	0	0	6
23:30	0	5	1	1	0	0	0	0	0	0	0	0	0	0	0	7
23:45	0	3	0	0	0	0	0	0	0	0	0	0	0	0	0	3
	0	23	1	1	2	1	0	0	0	0	0	0	0	0	0	28
Total	58	1658	291	8	35	2	0	8	8	1	0	0	0	8	0	2077
Percent	2.8%	79.8%	14.0%	0.4%	1.7%	0.1%	0.0%	0.4%	0.4%	0.0%	0.0%	0.0%	0.0%	0.4%	0.0%	

Tri-State Traffic Data, Inc

184 Baker Rd
Coatesville, PA 19320

Site Code: NY 211
Station ID: 000000000000
41.514745 -74.249629

Latitude: 0' 0.0000 Undefined

Direction 2 South

Start Time	Class 1	Class 2	Class 3	Class 4	Class 5	Class 6	Class 7	Class 8	Class 9	Class 10	Class 11	Class 12	Class 13	Class 14	Class 15	Total
06/10/1																
9	0	4	0	0	0	0	0	0	1	0	0	0	0	0	0	5
00:15	0	0	1	0	0	0	0	0	0	0	0	0	0	0	0	1
00:30	0	2	1	0	0	0	0	0	0	0	0	0	0	0	0	3
00:45	0	2	0	0	0	0	0	0	0	0	0	0	0	0	0	2
	0	8	2	0	0	0	0	0	1	0	0	0	0	0	0	11
01:00	0	1	1	0	0	0	0	0	0	0	0	0	0	0	0	2
01:15	0	2	0	0	0	0	0	0	0	0	0	0	0	0	0	2
01:30	0	1	0	0	0	0	0	0	0	0	0	0	0	0	0	1
01:45	0	0	0	0	0	0	0	0	0	0	0	0	0	0	0	0
	0	4	1	0	0	0	0	0	0	0	0	0	0	0	0	5
02:00	0	2	0	0	0	0	0	0	0	0	0	0	0	0	0	2
02:15	0	0	0	0	2	0	0	0	0	0	0	0	0	0	0	2
02:30	0	2	0	0	0	0	0	0	0	0	0	0	0	0	0	2
02:45	0	4	0	0	2	0	0	0	1	0	0	0	0	0	0	7
	0	8	0	0	4	0	0	0	1	0	0	0	0	0	0	13
03:00	0	3	0	0	0	0	0	0	0	0	0	0	0	0	0	3
03:15	0	5	3	0	0	0	0	0	0	0	0	0	0	0	0	8
03:30	0	4	3	0	0	0	0	0	0	0	0	0	0	0	0	7
03:45	0	4	2	0	0	0	0	0	0	0	0	0	0	0	0	6
	0	16	8	0	0	0	0	0	0	0	0	0	0	0	0	24
04:00	0	5	5	0	0	0	0	0	0	0	0	0	0	0	0	10
04:15	0	7	1	0	2	0	0	0	0	0	0	0	0	0	0	10
04:30	0	10	3	0	0	0	0	0	0	0	0	0	0	0	0	13
04:45	0	14	3	0	2	0	0	0	0	0	0	0	0	0	0	19
	0	36	12	0	4	0	0	0	0	0	0	0	0	0	0	52
05:00	0	17	6	0	0	0	0	0	0	0	0	0	0	0	0	23
05:15	0	26	2	0	1	0	0	0	0	0	0	0	0	0	0	29
05:30	0	23	3	0	1	0	0	0	0	0	0	0	0	0	0	27
05:45	0	23	13	0	0	0	0	0	0	0	0	0	0	0	0	36
	0	89	24	0	2	0	0	0	0	0	0	0	0	0	0	115
06:00	0	38	6	0	4	0	0	0	0	0	0	0	0	0	0	48
06:15	0	40	14	0	2	0	1	1	0	0	0	0	0	0	0	58
06:30	0	61	13	0	3	0	0	1	0	0	0	0	0	0	0	78
06:45	0	67	15	0	5	0	0	0	0	0	0	0	0	0	0	87
	0	206	48	0	14	0	1	2	0	0	0	0	0	0	0	271
07:00	0	52	17	2	3	1	0	1	0	0	0	0	0	0	0	76
07:15	0	29	4	0	0	0	0	2	0	0	0	0	0	0	0	35
07:30	*	*	*	*	*	*	*	*	*	*	*	*	*	*	*	*
07:45	*	*	*	*	*	*	*	*	*	*	*	*	*	*	*	*
	0	0	0	0	0	0	0	0	0	0	0	0	0	0	0	0
08:00	*	*	*	*	*	*	*	*	*	*	*	*	*	*	*	*
08:15	*	*	*	*	*	*	*	*	*	*	*	*	*	*	*	*
08:30	*	*	*	*	*	*	*	*	*	*	*	*	*	*	*	*
08:45	*	*	*	*	*	*	*	*	*	*	*	*	*	*	*	*
	0	0	0	0	0	0	0	0	0	0	0	0	0	0	0	0
09:00	*	*	*	*	*	*	*	*	*	*	*	*	*	*	*	*
09:15	*	*	*	*	*	*	*	*	*	*	*	*	*	*	*	*
09:30	*	*	*	*	*	*	*	*	*	*	*	*	*	*	*	*
09:45	*	*	*	*	*	*	*	*	*	*	*	*	*	*	*	*
	0	0	0	0	0	0	0	0	0	0	0	0	0	0	0	0
10:00	*	*	*	*	*	*	*	*	*	*	*	*	*	*	*	*
10:15	*	*	*	*	*	*	*	*	*	*	*	*	*	*	*	*
10:30	*	*	*	*	*	*	*	*	*	*	*	*	*	*	*	*
10:45	*	*	*	*	*	*	*	*	*	*	*	*	*	*	*	*
	0	0	0	0	0	0	0	0	0	0	0	0	0	0	0	0
11:00	*	*	*	*	*	*	*	*	*	*	*	*	*	*	*	*
11:15	*	*	*	*	*	*	*	*	*	*	*	*	*	*	*	*
11:30	*	*	*	*	*	*	*	*	*	*	*	*	*	*	*	*
11:45	*	*	*	*	*	*	*	*	*	*	*	*	*	*	*	*
Total	0	448	116	2	27	1	1	5	2	0	0	0	0	0	0	602
Percent	0.0%	74.4%	19.3%	0.3%	4.5%	0.2%	0.2%	0.8%	0.3%	0.0%	0.0%	0.0%	0.0%	0.0%	0.0%	
Grand Total	204	17349	3579	216	754	88	18	142	85	7	2	0	4	33	0	22481
Percent	0.9%	77.2%	15.9%	1.0%	3.4%	0.4%	0.1%	0.6%	0.4%	0.0%	0.0%	0.0%	0.0%	0.1%	0.0%	

MetroCount Traffic Executive Weekly Vehicle Counts (Virtual Week)

VirtWeeklyVehicle-129 -- English (ENU)

Datasets:

Site: [119-036] 300' S of NY-416
Attribute: NY-211
Direction: 5 - South bound A>B, North bound B>A. **Lane:** 2
Survey Duration: 15:54 Monday, March 28, 2022 => 12:31 Monday, April 4, 2022,
Zone:
File: 119-036 0 2022-04-04 1235_NY211.EC2 (Plus)
Identifier: BG78EVVB MC56-L5 [MC55] (c)Microcom 19Oct04
Algorithm: Factory default axle (v5.05)
Data type: Axle sensors - Paired (Class/Speed/Count)

Profile:

Filter time: 17:00 Monday, March 28, 2022 => 11:00 Monday, April 4, 2022 (6.75)
Included classes: 1, 2, 3, 4, 5, 6, 7, 8, 9, 10, 11, 12, 13
Speed range: 5 - 100 mph.
Direction: North, South (bound), P = North, Lane = 0-16
Separation: Headway > 0 sec, Span 0 - 300 ft
Name: Default Profile
Scheme: Vehicle classification (Scheme F3)
Units: Non metric (ft, mi, ft/s, mph, lb, ton)
In profile: Vehicles = 35032 / 35740 (98.02%)

Weekly Vehicle Counts (Virtual Week)

VirtWeeklyVehicle-129

Site: 119-036.2.3SN
Description: 300' S of NY-416
Filter time: 17:00 Monday, March 28, 2022 => 11:00 Monday, April 4, 2022
Scheme: Vehicle classification (Scheme F3)
Filter: Cls(1-13) Dir(NS) Sp(5,100) Headway(>0) Span(0 - 300) Lane(0-16)

Hour	Mon	Tue	Wed	Thu	Fri	Sat	Sun	Averages	
								1 - 5	1 - 7
0000-0100	25.0	27.0	26.0	31.0	23.0	43.0	42.0	26.4	31.0
0100-0200	17.0	12.0	28.0	18.0	23.0	16.0	16.0	19.6	18.6
0200-0300	30.0	20.0	20.0	20.0	17.0	13.0	21.0	21.4	20.1
0300-0400	25.0	27.0	21.0	29.0	27.0	14.0	9.0	25.8	21.7
0400-0500	37.0	39.0	40.0	52.0	42.0	21.0	10.0	42.0	34.4
0500-0600	73.0	84.0	76.0	65.0	70.0	25.0	16.0	73.6	58.4
0600-0700	183.0	167.0	194.0	185.0	181.0	64.0	48.0	182.0	146.0
0700-0800	353.0	347.0	341.0	315.0	346.0	112.0	60.0	340.4	267.7
0800-0900	410.0	410.0	397.0	400.0	414.0	222.0	136.0	406.2	341.3
0900-1000	317.0	352.0	364.0	330.0	351.0	267.0	179.0	342.8	308.6
1000-1100	315.0	301.0	344.0	333.0	337.0	323.0	262.0	326.0	316.4
1100-1200	*	367.0	324.0	358.0	344.0	404.0	275.0	348.3	345.3
1200-1300	*	378.0	333.0	353.0	406.0	474.0	347.0	367.5	381.8
1300-1400	*	368.0	344.0	365.0	418.0	435.0	339.0	373.8	378.2
1400-1500	*	387.0	436.0	396.0	439.0	482.0	304.0	414.5	407.3
1500-1600	*	462.0	497.0	444.0	470.0	430.0	281.0	468.3	430.7
1600-1700	*	500.0	503.0	478.0	501.0	382.0	288.0	495.5	442.0
1700-1800	440.0	444.0	509.0	471.0	508.0	428.0	259.0	474.4	437.0
1800-1900	297.0	312.0	289.0	300.0	394.0	350.0	206.0	318.4	306.9
1900-2000	191.0	226.0	245.0	234.0	279.0	260.0	142.0	235.0	225.3
2000-2100	139.0	189.0	162.0	166.0	202.0	196.0	158.0	171.6	173.1
2100-2200	82.0	99.0	138.0	113.0	115.0	175.0	73.0	109.4	113.6
2200-2300	61.0	57.0	84.0	52.0	107.0	159.0	46.0	72.2	80.9
2300-2400	52.0	65.0	67.0	48.0	58.0	81.0	42.0	58.0	59.0
Totals									
0700-1900	*	4628.0	4681.0	4543.0	4928.0	4309.0	2936.0	4675.9	4363.2
0600-2200	*	5309.0	5420.0	5241.0	5705.0	5004.0	3357.0	5373.9	5021.2
0600-0000	*	5431.0	5571.0	5341.0	5870.0	5244.0	3445.0	5504.1	5161.0
0000-0000	*	5640.0	5782.0	5556.0	6072.0	5376.0	3559.0	5712.9	5345.3
AM Peak	*	0800	0800	0800	0800	1100	1100		
	*	410.0	397.0	400.0	414.0	404.0	275.0		
PM Peak	*	1600	1700	1600	1700	1400	1200		
	*	500.0	509.0	478.0	508.0	482.0	347.0		

* - No data.

MetroCount Traffic Executive Weekly Vehicle Counts (Virtual Week)

VirtWeeklyVehicle-127 -- English (ENU)

Datasets:

Site: [119-036] 300' S of NY-416
Attribute: NY-211
Direction: 5 - South bound A>B, North bound B>A. **Lane:** 2
Survey Duration: 15:54 Monday, March 28, 2022 => 12:31 Monday, April 4, 2022,
Zone:
File: 119-036 0 2022-04-04 1235_NY211.EC2 (Plus)
Identifier: BG78EVVB MC56-L5 [MC55] (c)Microcom 19Oct04
Algorithm: Factory default axle (v5.05)
Data type: Axle sensors - Paired (Class/Speed/Count)

Profile:

Filter time: 17:00 Monday, March 28, 2022 => 11:00 Monday, April 4, 2022 (6.75)
Included classes: 1, 2, 3, 4, 5, 6, 7, 8, 9, 10, 11, 12, 13
Speed range: 5 - 100 mph.
Direction: BA , Lane = 0-16
Separation: Headway > 0 sec, Span 0 - 300 ft
Name: Default Profile
Scheme: Vehicle classification (Scheme F3)
Units: Non metric (ft, mi, ft/s, mph, lb, ton)
In profile: Vehicles = 18161 / 35740 (50.81%)

Weekly Vehicle Counts (Virtual Week)

VirtWeeklyVehicle-127

Site: 119-036.2.3SN
Description: 300' S of NY-416
Filter time: 17:00 Monday, March 28, 2022 => 11:00 Monday, April 4, 2022
Scheme: Vehicle classification (Scheme F3)
Filter: Cls(1-13) Dir(NB) Sp(5,100) Headway(>0) Span(0 - 300) Lane(0-16)

Hour	Mon	Tue	Wed	Thu	Fri	Sat	Sun	Averages	
								1 - 5	1 - 7
0000-0100	20.0	18.0	12.0	15.0	14.0	25.0	28.0	15.8	18.9
0100-0200	8.0	5.0	15.0	7.0	13.0	9.0	8.0	9.6	9.3
0200-0300	15.0	7.0	15.0	5.0	4.0	7.0	12.0	9.2	9.3
0300-0400	12.0	14.0	13.0	11.0	10.0	7.0	6.0	12.0	10.4
0400-0500	17.0	15.0	16.0	27.0	13.0	9.0	2.0	17.6	14.1
0500-0600	26.0	36.0	30.0	21.0	26.0	5.0	6.0	27.8	21.4
0600-0700	65.0	67.0	76.0	80.0	75.0	30.0	16.0	72.6	58.4
0700-0800	113.0	112.0	123.0	109.0	116.0	53.0	30.0	114.6	93.7
0800-0900	149.0	157.0	154.0	148.0	162.0	96.0	57.0	154.0	131.9
0900-1000	131.0	144.0	143.0	112.0	144.0	107.0	75.0	134.8	122.3
1000-1100	141.0	144.0	143.0	139.0	161.0	128.0	97.0	145.6	136.1
1100-1200	*	173.0	157.0	181.0	181.0	180.0	123.0	173.0	165.8
1200-1300	*	190.0	169.0	201.0	193.0	231.0	147.0	188.3	188.5
1300-1400	*	195.0	176.0	198.0	204.0	219.0	182.0	193.3	195.7
1400-1500	*	214.0	227.0	231.0	260.0	277.0	189.0	233.0	233.0
1500-1600	*	262.0	291.0	245.0	250.0	245.0	172.0	262.0	244.2
1600-1700	*	325.0	309.0	289.0	301.0	224.0	163.0	306.0	268.5
1700-1800	265.0	281.0	288.0	291.0	304.0	234.0	152.0	285.8	259.3
1800-1900	184.0	154.0	179.0	168.0	224.0	182.0	116.0	181.8	172.4
1900-2000	131.0	141.0	169.0	149.0	184.0	155.0	93.0	154.8	146.0
2000-2100	101.0	136.0	114.0	110.0	133.0	132.0	103.0	118.8	118.4
2100-2200	57.0	64.0	89.0	74.0	70.0	127.0	35.0	70.8	73.7
2200-2300	37.0	31.0	50.0	31.0	51.0	119.0	25.0	40.0	49.1
2300-2400	36.0	35.0	48.0	32.0	39.0	51.0	32.0	38.0	39.0
Totals									
0700-1900	*	2351.0	2359.0	2312.0	2500.0	2176.0	1503.0	2372.1	2211.4
0600-2200	*	2759.0	2807.0	2725.0	2962.0	2620.0	1750.0	2789.1	2608.0
0600-0000	*	2825.0	2905.0	2788.0	3052.0	2790.0	1807.0	2867.1	2696.1
0000-0000	*	2920.0	3006.0	2874.0	3132.0	2852.0	1869.0	2959.1	2779.5
AM Peak	*	1100	1100	1100	1100	1100	1100		
	*	173.0	157.0	181.0	181.0	180.0	123.0		
PM Peak	*	1600	1600	1700	1700	1400	1400		
	*	325.0	309.0	291.0	304.0	277.0	189.0		

* - No data.

MetroCount Traffic Executive Weekly Vehicle Counts (Virtual Week)

VirtWeeklyVehicle-128 -- English (ENU)

Datasets:

Site: [119-036] 300' S of NY-416
Attribute: NY-211
Direction: 5 - South bound A>B, North bound B>A. **Lane:** 2
Survey Duration: 15:54 Monday, March 28, 2022 => 12:31 Monday, April 4, 2022,
Zone:
File: 119-036 0 2022-04-04 1235_NY211.EC2 (Plus)
Identifier: BG78EVVB MC56-L5 [MC55] (c)Microcom 19Oct04
Algorithm: Factory default axle (v5.05)
Data type: Axle sensors - Paired (Class/Speed/Count)

Profile:

Filter time: 17:00 Monday, March 28, 2022 => 11:00 Monday, April 4, 2022 (6.75)
Included classes: 1, 2, 3, 4, 5, 6, 7, 8, 9, 10, 11, 12, 13
Speed range: 5 - 100 mph.
Direction: AB , Lane = 0-16
Separation: Headway > 0 sec, Span 0 - 300 ft
Name: Default Profile
Scheme: Vehicle classification (Scheme F3)
Units: Non metric (ft, mi, ft/s, mph, lb, ton)
In profile: Vehicles = 16871 / 35740 (47.20%)

Weekly Vehicle Counts (Virtual Week)

VirtWeeklyVehicle-128

Site: 119-036.2.3SN
Description: 300' S of NY-416
Filter time: 17:00 Monday, March 28, 2022 => 11:00 Monday, April 4, 2022
Scheme: Vehicle classification (Scheme F3)
Filter: Cls(1-13) Dir(SB) Sp(5,100) Headway(>0) Span(0 - 300) Lane(0-16)

Hour	Mon	Tue	Wed	Thu	Fri	Sat	Sun	Averages	
								1 - 5	1 - 7
0000-0100	5.0	9.0	14.0	16.0	9.0	18.0	14.0	10.6	12.1
0100-0200	9.0	7.0	13.0	11.0	10.0	7.0	8.0	10.0	9.3
0200-0300	15.0	13.0	5.0	15.0	13.0	6.0	9.0	12.2	10.9
0300-0400	13.0	13.0	8.0	18.0	17.0	7.0	3.0	13.8	11.3
0400-0500	20.0	24.0	24.0	25.0	29.0	12.0	8.0	24.4	20.3
0500-0600	47.0	48.0	46.0	44.0	44.0	20.0	10.0	45.8	37.0
0600-0700	118.0	100.0	118.0	105.0	106.0	34.0	32.0	109.4	87.6
0700-0800	240.0	235.0	218.0	206.0	230.0	59.0	30.0	225.8	174.0
0800-0900	261.0	253.0	243.0	252.0	252.0	126.0	79.0	252.2	209.4
0900-1000	186.0	208.0	221.0	218.0	207.0	160.0	104.0	208.0	186.3
1000-1100	174.0	157.0	201.0	194.0	176.0	195.0	165.0	180.4	180.3
1100-1200	*	194.0	167.0	177.0	163.0	224.0	152.0	175.3	179.5
1200-1300	*	188.0	164.0	152.0	213.0	243.0	200.0	179.3	193.3
1300-1400	*	173.0	168.0	167.0	214.0	216.0	157.0	180.5	182.5
1400-1500	*	173.0	209.0	165.0	179.0	205.0	115.0	181.5	174.3
1500-1600	*	200.0	206.0	199.0	220.0	185.0	109.0	206.3	186.5
1600-1700	*	175.0	194.0	189.0	200.0	158.0	125.0	189.5	173.5
1700-1800	175.0	163.0	221.0	180.0	204.0	194.0	107.0	188.6	177.7
1800-1900	113.0	158.0	110.0	132.0	170.0	168.0	90.0	136.6	134.4
1900-2000	60.0	85.0	76.0	85.0	95.0	105.0	49.0	80.2	79.3
2000-2100	38.0	53.0	48.0	56.0	69.0	64.0	55.0	52.8	54.7
2100-2200	25.0	35.0	49.0	39.0	45.0	48.0	38.0	38.6	39.9
2200-2300	24.0	26.0	34.0	21.0	56.0	40.0	21.0	32.2	31.7
2300-2400	16.0	30.0	19.0	16.0	19.0	30.0	10.0	20.0	20.0
Totals									
0700-1900	*	2277.0	2322.0	2231.0	2428.0	2133.0	1433.0	2303.8	2151.8
0600-2200	*	2550.0	2613.0	2516.0	2743.0	2384.0	1607.0	2584.8	2413.2
0600-0000	*	2606.0	2666.0	2553.0	2818.0	2454.0	1638.0	2637.0	2465.0
0000-0000	*	2720.0	2776.0	2682.0	2940.0	2524.0	1690.0	2753.8	2565.8
AM Peak	*	0800	0800	0800	0800	1100	1000		
	*	253.0	243.0	252.0	252.0	224.0	165.0		
PM Peak	*	1500	1700	1500	1500	1200	1200		
	*	200.0	221.0	199.0	220.0	243.0	200.0		

* - No data.

MetroCount Traffic Executive Weekly Vehicle Counts (Virtual Week)

VirtWeeklyVehicle-126 -- English (ENU)

Datasets:

Site: [119-036] 300' S of NY-211
Attribute: NY-416
Direction: 5 - South bound A>B, North bound B>A. **Lane:** 1
Survey Duration: 15:31 Monday, March 28, 2022 => 12:27 Monday, April 4, 2022,
Zone:
File: 119-036 0 2022-04-04 1230_NY416.EC1 (Plus)
Identifier: S1328N62 MC56-L5 [MC55] (c)Microcom 19Oct04
Algorithm: Factory default axle (v5.05)
Data type: Axle sensors - Paired (Class/Speed/Count)

Profile:

Filter time: 17:00 Monday, March 28, 2022 => 11:00 Monday, April 4, 2022 (6.75)
Included classes: 1, 2, 3, 4, 5, 6, 7, 8, 9, 10, 11, 12, 13
Speed range: 5 - 100 mph.
Direction: North, South (bound), P = North, Lane = 0-16
Separation: Headway > 0 sec, Span 0 - 300 ft
Name: Default Profile
Scheme: Vehicle classification (Scheme F3)
Units: Non metric (ft, mi, ft/s, mph, lb, ton)
In profile: Vehicles = 22613 / 23164 (97.62%)

Weekly Vehicle Counts (Virtual Week)

VirtWeeklyVehicle-126

Site: 119-036.1.2SN
 Description: 300' S of NY-211
 Filter time: 17:00 Monday, March 28, 2022 => 11:00 Monday, April 4, 2022
 Scheme: Vehicle classification (Scheme F3)
 Filter: Cls(1-13) Dir(NS) Sp(5,100) Headway(>0) Span(0 - 300) Lane(0-16)

Hour	Mon	Tue	Wed	Thu	Fri	Sat	Sun	Averages	
								1 - 5	1 - 7
0000-0100	24.0	21.0	25.0	37.0	22.0	29.0	25.0	25.8	26.1
0100-0200	23.0	20.0	31.0	24.0	24.0	18.0	12.0	24.4	21.7
0200-0300	33.0	46.0	37.0	43.0	40.0	13.0	10.0	39.8	31.7
0300-0400	34.0	34.0	38.0	46.0	32.0	10.0	3.0	36.8	28.1
0400-0500	70.0	83.0	74.0	86.0	76.0	23.0	8.0	77.8	60.0
0500-0600	93.0	100.0	104.0	90.0	83.0	35.0	24.0	94.0	75.6
0600-0700	180.0	181.0	200.0	186.0	189.0	56.0	27.0	187.2	145.6
0700-0800	329.0	335.0	317.0	309.0	319.0	101.0	46.0	321.8	250.9
0800-0900	322.0	313.0	316.0	302.0	310.0	157.0	100.0	312.6	260.0
0900-1000	218.0	218.0	235.0	211.0	221.0	171.0	123.0	220.6	199.6
1000-1100	207.0	183.0	208.0	168.0	218.0	181.0	97.0	196.8	180.3
1100-1200	*	203.0	191.0	223.0	212.0	226.0	137.0	207.3	198.7
1200-1300	*	210.0	189.0	204.0	256.0	252.0	118.0	214.8	204.8
1300-1400	*	221.0	252.0	220.0	207.0	200.0	111.0	225.0	201.8
1400-1500	*	249.0	253.0	249.0	304.0	220.0	128.0	263.8	233.8
1500-1600	*	332.0	347.0	309.0	291.0	229.0	121.0	319.8	271.5
1600-1700	*	305.0	356.0	362.0	284.0	227.0	111.0	326.8	274.2
1700-1800	279.0	288.0	317.0	306.0	274.0	173.0	94.0	292.8	247.3
1800-1900	158.0	193.0	188.0	179.0	175.0	161.0	90.0	178.6	163.4
1900-2000	120.0	130.0	131.0	126.0	145.0	112.0	64.0	130.4	118.3
2000-2100	80.0	83.0	113.0	119.0	92.0	74.0	51.0	97.4	87.4
2100-2200	70.0	76.0	60.0	55.0	71.0	78.0	33.0	66.4	63.3
2200-2300	46.0	49.0	43.0	55.0	54.0	38.0	39.0	49.4	46.3
2300-2400	29.0	34.0	51.0	34.0	50.0	38.0	29.0	39.6	37.9
Totals									
0700-1900	*	3050.0	3169.0	3042.0	3071.0	2298.0	1276.0	3080.5	2686.3
0600-2200	*	3520.0	3673.0	3528.0	3568.0	2618.0	1451.0	3561.9	3100.8
0600-0000	*	3603.0	3767.0	3617.0	3672.0	2694.0	1519.0	3650.9	3185.0
0000-0000	*	3907.0	4076.0	3943.0	3949.0	2822.0	1601.0	3949.5	3428.3
AM Peak	*	0700	0700	0700	0700	1100	1100		
	*	335.0	317.0	309.0	319.0	226.0	137.0		
PM Peak	*	1500	1600	1600	1400	1200	1400		
	*	332.0	356.0	362.0	304.0	252.0	128.0		

* - No data.

MetroCount Traffic Executive Weekly Vehicle Counts (Virtual Week)

VirtWeeklyVehicle-124 -- English (ENU)

Datasets:

Site: [119-036] 300' S of NY-211
Attribute: NY-416
Direction: 5 - South bound A>B, North bound B>A. **Lane:** 1
Survey Duration: 15:31 Monday, March 28, 2022 => 12:27 Monday, April 4, 2022,
Zone:
File: 119-036 0 2022-04-04 1230_NY416.EC1 (Plus)
Identifier: S1328N62 MC56-L5 [MC55] (c)Microcom 19Oct04
Algorithm: Factory default axle (v5.05)
Data type: Axle sensors - Paired (Class/Speed/Count)

Profile:

Filter time: 17:00 Monday, March 28, 2022 => 11:00 Monday, April 4, 2022 (6.75)
Included classes: 1, 2, 3, 4, 5, 6, 7, 8, 9, 10, 11, 12, 13
Speed range: 5 - 100 mph.
Direction: AB , Lane = 0-16
Separation: Headway > 0 sec, Span 0 - 300 ft
Name: Default Profile
Scheme: Vehicle classification (Scheme F3)
Units: Non metric (ft, mi, ft/s, mph, lb, ton)
In profile: Vehicles = 11116 / 23164 (47.99%)

Weekly Vehicle Counts (Virtual Week)

VirtWeeklyVehicle-124

Site: 119-036.1.2SN
Description: 300' S of NY-211
Filter time: 17:00 Monday, March 28, 2022 => 11:00 Monday, April 4, 2022
Scheme: Vehicle classification (Scheme F3)
Filter: Cls(1-13) Dir(NB) Sp(5,100) Headway(>0) Span(0 - 300) Lane(0-16)

Hour	Mon	Tue	Wed	Thu	Fri	Sat	Sun	Averages	
								1 - 5	1 - 7
0000-0100	19.0	14.0	12.0	16.0	9.0	16.0	9.0	14.0	13.6
0100-0200	8.0	11.0	18.0	11.0	15.0	4.0	4.0	12.6	10.1
0200-0300	22.0	20.0	18.0	20.0	21.0	6.0	9.0	20.2	16.6
0300-0400	22.0	19.0	15.0	15.0	18.0	5.0	1.0	17.8	13.6
0400-0500	48.0	55.0	54.0	62.0	51.0	14.0	5.0	54.0	41.3
0500-0600	65.0	68.0	67.0	56.0	53.0	23.0	13.0	61.8	49.3
0600-0700	130.0	127.0	139.0	138.0	137.0	36.0	19.0	134.2	103.7
0700-0800	228.0	239.0	218.0	214.0	223.0	66.0	26.0	224.4	173.4
0800-0900	187.0	167.0	194.0	178.0	176.0	80.0	55.0	180.4	148.1
0900-1000	126.0	133.0	122.0	120.0	130.0	84.0	69.0	126.2	112.0
1000-1100	108.0	80.0	103.0	77.0	86.0	94.0	48.0	90.8	85.1
1100-1200	*	100.0	84.0	103.0	96.0	109.0	61.0	95.8	92.2
1200-1300	*	100.0	85.0	111.0	113.0	120.0	62.0	102.3	98.5
1300-1400	*	105.0	109.0	106.0	109.0	102.0	61.0	107.3	98.7
1400-1500	*	112.0	112.0	104.0	112.0	95.0	51.0	110.0	97.7
1500-1600	*	128.0	159.0	133.0	119.0	106.0	53.0	134.8	116.3
1600-1700	*	99.0	142.0	118.0	102.0	80.0	55.0	115.3	99.3
1700-1800	105.0	99.0	109.0	95.0	100.0	80.0	29.0	101.6	88.1
1800-1900	54.0	82.0	77.0	65.0	64.0	79.0	43.0	68.4	66.3
1900-2000	39.0	47.0	47.0	49.0	48.0	54.0	30.0	46.0	44.9
2000-2100	33.0	26.0	53.0	48.0	44.0	32.0	26.0	40.8	37.4
2100-2200	29.0	23.0	22.0	18.0	29.0	37.0	17.0	24.2	25.0
2200-2300	27.0	30.0	29.0	30.0	26.0	19.0	19.0	28.4	25.7
2300-2400	10.0	16.0	31.0	17.0	15.0	13.0	18.0	17.8	17.1
Totals									
0700-1900	*	1444.0	1514.0	1424.0	1430.0	1095.0	613.0	1457.0	1275.8
0600-2200	*	1667.0	1775.0	1677.0	1688.0	1254.0	705.0	1702.3	1486.8
0600-0000	*	1713.0	1835.0	1724.0	1729.0	1286.0	742.0	1748.5	1529.7
0000-0000	*	1900.0	2019.0	1904.0	1896.0	1354.0	783.0	1928.9	1674.1
AM Peak	*	0700	0700	0700	0700	1100	0900		
	*	239.0	218.0	214.0	223.0	109.0	69.0		
PM Peak	*	1500	1500	1500	1500	1200	1200		
	*	128.0	159.0	133.0	119.0	120.0	62.0		

* - No data.

MetroCount Traffic Executive Weekly Vehicle Counts (Virtual Week)

VirtWeeklyVehicle-125 -- English (ENU)

Datasets:

Site: [119-036] 300' S of NY-211
Attribute: NY-416
Direction: 5 - South bound A>B, North bound B>A. **Lane:** 1
Survey Duration: 15:31 Monday, March 28, 2022 => 12:27 Monday, April 4, 2022,
Zone:
File: 119-036 0 2022-04-04 1230_NY416.EC1 (Plus)
Identifier: S1328N62 MC56-L5 [MC55] (c)Microcom 19Oct04
Algorithm: Factory default axle (v5.05)
Data type: Axle sensors - Paired (Class/Speed/Count)

Profile:

Filter time: 17:00 Monday, March 28, 2022 => 11:00 Monday, April 4, 2022 (6.75)
Included classes: 1, 2, 3, 4, 5, 6, 7, 8, 9, 10, 11, 12, 13
Speed range: 5 - 100 mph.
Direction: BA , Lane = 0-16
Separation: Headway > 0 sec, Span 0 - 300 ft
Name: Default Profile
Scheme: Vehicle classification (Scheme F3)
Units: Non metric (ft, mi, ft/s, mph, lb, ton)
In profile: Vehicles = 11497 / 23164 (49.63%)

Weekly Vehicle Counts (Virtual Week)

VirtWeeklyVehicle-125

Site: 119-036.1.2SN
Description: 300' S of NY-211
Filter time: 17:00 Monday, March 28, 2022 => 11:00 Monday, April 4, 2022
Scheme: Vehicle classification (Scheme F3)
Filter: Cls(1-13) Dir(BA) Sp(5,100) Headway(>0) Span(0 - 300) Lane(0-16)

Hour	Mon	Tue	Wed	Thu	Fri	Sat	Sun	Averages	
								1 - 5	1 - 7
0000-0100	5.0	7.0	13.0	21.0	13.0	13.0	16.0	11.8	12.6
0100-0200	15.0	9.0	13.0	13.0	9.0	14.0	8.0	11.8	11.6
0200-0300	11.0	26.0	19.0	23.0	19.0	7.0	1.0	19.6	15.1
0300-0400	12.0	15.0	23.0	31.0	14.0	5.0	2.0	19.0	14.6
0400-0500	22.0	28.0	20.0	24.0	25.0	9.0	3.0	23.8	18.7
0500-0600	28.0	32.0	37.0	34.0	30.0	12.0	11.0	32.2	26.3
0600-0700	50.0	54.0	61.0	48.0	52.0	20.0	8.0	53.0	41.9
0700-0800	101.0	96.0	99.0	95.0	96.0	35.0	20.0	97.4	77.4
0800-0900	135.0	146.0	122.0	124.0	134.0	77.0	45.0	132.2	111.9
0900-1000	92.0	85.0	113.0	91.0	91.0	87.0	54.0	94.4	87.6
1000-1100	99.0	103.0	105.0	91.0	132.0	87.0	49.0	106.0	95.1
1100-1200	*	103.0	107.0	120.0	116.0	117.0	76.0	111.5	106.5
1200-1300	*	110.0	104.0	93.0	143.0	132.0	56.0	112.5	106.3
1300-1400	*	116.0	143.0	114.0	98.0	98.0	50.0	117.8	103.2
1400-1500	*	137.0	141.0	145.0	192.0	125.0	77.0	153.8	136.2
1500-1600	*	204.0	188.0	176.0	172.0	123.0	68.0	185.0	155.2
1600-1700	*	206.0	214.0	244.0	182.0	147.0	56.0	211.5	174.8
1700-1800	174.0	189.0	208.0	211.0	174.0	93.0	65.0	191.2	159.1
1800-1900	104.0	111.0	111.0	114.0	111.0	82.0	47.0	110.2	97.1
1900-2000	81.0	83.0	84.0	77.0	97.0	58.0	34.0	84.4	73.4
2000-2100	47.0	57.0	60.0	71.0	48.0	42.0	25.0	56.6	50.0
2100-2200	41.0	53.0	38.0	37.0	42.0	41.0	16.0	42.2	38.3
2200-2300	19.0	19.0	14.0	25.0	28.0	19.0	20.0	21.0	20.6
2300-2400	19.0	18.0	20.0	17.0	35.0	25.0	11.0	21.8	20.7
Totals									
0700-1900	*	1606.0	1655.0	1618.0	1641.0	1203.0	663.0	1623.4	1410.5
0600-2200	*	1853.0	1898.0	1851.0	1880.0	1364.0	746.0	1859.6	1614.0
0600-0000	*	1890.0	1932.0	1893.0	1943.0	1408.0	777.0	1902.4	1655.3
0000-0000	*	2007.0	2057.0	2039.0	2053.0	1468.0	818.0	2020.6	1754.2
AM Peak	*	0800	0800	0800	0800	1100	1100		
	*	146.0	122.0	124.0	134.0	117.0	76.0		
PM Peak	*	1600	1600	1600	1400	1600	1400		
	*	206.0	214.0	244.0	192.0	147.0	77.0		

* - No data.

Attachment C

Level of Service

**Traffic Impact Assessment
KSH Development
Village of Montgomery, New York**

LOS Definitions

The following is an excerpt from the 2000 Highway Capacity Manual (HCM).

Level of Service for Signalized Intersections

Level of service for a signalized intersection is defined in terms of control delay, which is a measure of driver discomfort, frustration, fuel consumption, and increased travel time. The delay experienced by a motorist is made up of a number of factors that relate to control, geometrics, traffic, and incidents. Total delay is the difference between the travel time actually experienced and the reference travel time that would result during base conditions: in the absence of traffic control, geometric delay, any incidents, and any other vehicles. Specifically, LOS criteria for traffic signals are stated in terms of the average control delay per vehicle, typically for a 15-minute analysis period. Delay is a complex measure and depends on a number of variables, including the quality of progression, the cycle length, the green ratio, and the v/c ratio for the lane group. Levels of service are defined to represent reasonable ranges in control delay.

LOS A describes operations with low control delay, up to 10 s/veh. This LOS occurs when progression is extremely favorable and most vehicles arrive during the green phase. Many vehicles do not stop at all. Short cycle lengths may tend to contribute to low delay.

LOS B describes operations with control delay greater than 10 and up to 20 s/veh. This level generally occurs with good progression, short cycle lengths, or both. More vehicles stop than with LOS A, causing higher levels of delay.

LOS C describes operations with control delay greater than 20 and up to 35 s/veh. These higher delays may result from only fair progression, longer cycle lengths, or both. Individual cycle failures may begin to appear at this level. Cycle failure occurs when a given green phase does not serve queued vehicles, and overflows occur. The number of vehicles stopping is significant at this level, though many still pass through the intersection without stopping.

LOS D describes operations with control delay greater than 35 and up to 55 s/veh. At LOS D, the influence of congestion becomes more noticeable. Longer delays may result from some combination of unfavorable progression, long cycle lengths, and high v/c ratios. Many vehicles stop, and the proportion of vehicles not stopping declines. Individual cycle failures are noticeable.

LOS E describes operations with control delay greater than 55 and up to 80 s/veh. These high delay values generally indicate poor progression, long cycle lengths, and high v/c ratios. Individual cycle failures are frequent.

LOS F describes operations with control delay in excess of 80 s/veh. This level, considered unacceptable to most drivers, often occurs with oversaturation, that is, when arrival flow rates exceed the capacity of lane groups. It may also occur at high v/c ratios with many individual cycle failures. Poor progression and long cycle lengths may also contribute significantly to high delay levels.

Level of Service Criteria for Unsignalized Intersections

Four measures are used to describe the performance of two-way stop controlled intersections: control delay, delay to major street through vehicles, queue length, and v/c ratio. The primary measure that is used to provide an estimate of LOS is control delay. This measure can be estimated for any movement on the minor (i.e., stop-controlled) street. By summing delay estimates for individual movements, a delay estimate for each minor street movement and minor street approach can be achieved. The level of service criteria is given in Exhibit 17-2/22.

For all-way stop controlled (AWSC) intersections, the average control delay (in seconds per vehicle) is used as the primary measure of performance. Control delay is the increased time of travel for a vehicle approaching and passing through an AWSC intersection, compared with a free-flow vehicle if it were not required to slow or stop at the intersection.

Exhibit 17-2/22: Level-of-Service Criteria for Stop Controlled Intersections

Level of Service	Control Delay (sec/veh)
A	≤ 10.0
B	>10.0 and ≤ 15.0
C	>15.0 and ≤ 25.0
D	>25.0 and ≤ 35.0
E	>35.0 and ≤ 50.0
F	>50.0

Level of Service Criteria for Unsignalized Intersections

Level of service (LOS) for Two-Way Stop-Controlled (TWSC) intersections is determined by the computed or measured control delay. For motor vehicles, LOS is determined for each minor-street movement (or shared movement) as well as major-street left turns by using criteria given in Exhibit 20-2. LOS is not defined for the intersection as a whole or for major-street approaches for three primary reasons: (a) major-street through vehicles are assumed to experience zero delay; (b) the disproportionate number of major-street through vehicles at a typical TWSC intersection skews the weighted average of all movements, resulting in a very low overall average delay for all vehicles; and (c) the resulting low delay can mask important LOS deficiencies for minor movements. LOS F is assigned to the movement if the volume-to-capacity (v/c) ratio for the movement exceeds 1.0, regardless of the control delay.

The LOS criteria for TWSC intersections are somewhat different from the criteria used in Chapter 18 for signalized intersections, primarily because user perceptions differ among transportation facility types. The expectation is that a signalized intersection is designed to carry higher traffic volumes and will present greater delay than an unsignalized intersection. Unsignalized intersections are also associated with more uncertainty for users, as delays are less predictable than they are at signals, which can reduce users' delay tolerance.

















The LOS criteria for All-Way Stop-Controlled (AWSC) intersections are given in Exhibit 21-8. LOS F is assigned if the v/c ratio of a lane exceeds 1.0, regardless of the control delay. For assessment of LOS at the approach and intersection levels, LOS is based solely on control delay.

**Exhibits 20-2/21-8:
Level-of-Service Criteria for Stop Controlled Intersections**

Control Delay (s/veh)	LOS by Volume-to-Capacity Ratio	
	v/c ≤ 1.0	v/c ≥ 1.0
10.0	A	F
>10.0 and ≤ 15.0	B	F
>15.0 and ≤ 25.0	C	F
>25.0 and ≤ 35.0	D	F
>35.0 and ≤ 50.0	E	F
>50.0	F	F

HCM Signalized Intersection Capacity Analysis
119-036; KSH Development

1: NY Route 211/Drwy & NY Route 17K
Existing 2019_AM Peak Hour

												
Movement	EBL	EBT	EBR	WBL	WBT	WBR	NBL	NBT	NBR	SBL	SBT	SBR
Lane Configurations												
Traffic Volume (vph)	0	537	218	110	173	0	104	1	79	1	3	1
Future Volume (vph)	0	537	218	110	173	0	104	1	79	1	3	1
Ideal Flow (vphpl)	1900	1900	1900	1900	1900	1900	1900	1900	1900	1900	1900	1900
Total Lost time (s)		5.0			5.0			5.0			5.0	
Lane Util. Factor		1.00			1.00			1.00			1.00	
Frbp, ped/bikes		1.00			1.00			1.00			1.00	
Flpb, ped/bikes		1.00			1.00			1.00			1.00	
Frt		0.96			1.00			0.94			0.97	
Flt Protected		1.00			0.98			0.97			0.99	
Satd. Flow (prot)		1737			1653			1579			1830	
Flt Permitted		1.00			0.54			0.82			0.93	
Satd. Flow (perm)		1737			905			1335			1726	
Peak-hour factor, PHF	0.97	0.97	0.97	0.97	0.97	0.97	0.97	0.97	0.97	0.97	0.97	0.97
Adj. Flow (vph)	0	554	225	113	178	0	107	1	81	1	3	1
RTOR Reduction (vph)	0	20	0	0	0	0	0	28	0	0	1	0
Lane Group Flow (vph)	0	759	0	0	291	0	0	161	0	0	4	0
Confl. Peds. (#/hr)	4					4						
Heavy Vehicles (%)	0%	6%	3%	14%	12%	0%	12%	0%	8%	0%	0%	0%
Turn Type		NA		pm+pt	NA		Perm	NA		Perm	NA	
Protected Phases		1		2	5			3			3	
Permitted Phases	1			5			3			3		
Actuated Green, G (s)		32.7			32.7			10.1			10.1	
Effective Green, g (s)		32.7			32.7			10.1			10.1	
Actuated g/C Ratio		0.62			0.62			0.19			0.19	
Clearance Time (s)		5.0			5.0			5.0			5.0	
Vehicle Extension (s)		4.0			4.0			2.0			2.0	
Lane Grp Cap (vph)		1075			560			255			330	
v/s Ratio Prot		c0.44										
v/s Ratio Perm					0.32			c0.12			0.00	
v/c Ratio		0.71			0.52			0.63			0.01	
Uniform Delay, d1		6.8			5.6			19.6			17.3	
Progression Factor		1.00			1.00			1.00			1.00	
Incremental Delay, d2		2.3			1.1			3.7			0.0	
Delay (s)		9.1			6.7			23.3			17.3	
Level of Service		A			A			C			B	
Approach Delay (s)		9.1			6.7			23.3			17.3	
Approach LOS		A			A			C			B	
Intersection Summary												
HCM 2000 Control Delay			10.7				HCM 2000 Level of Service				B	
HCM 2000 Volume to Capacity ratio			0.78									
Actuated Cycle Length (s)			52.8				Sum of lost time (s)			15.0		
Intersection Capacity Utilization			86.5%				ICU Level of Service			E		
Analysis Period (min)			15									

c Critical Lane Group

Intersection												
Int Delay, s/veh	1											
Movement	EBL	EBT	EBR	WBL	WBT	WBR	NBL	NBT	NBR	SBL	SBT	SBR
Lane Configurations		↕			↕			↕			↕	
Traffic Vol, veh/h	13	0	6	9	1	12	1	209	7	15	419	8
Future Vol, veh/h	13	0	6	9	1	12	1	209	7	15	419	8
Conflicting Peds, #/hr	2	0	0	0	0	2	3	0	7	7	0	3
Sign Control	Stop	Stop	Stop	Stop	Stop	Stop	Free	Free	Free	Free	Free	Free
RT Channelized	-	-	None	-	-	None	-	-	None	-	-	None
Storage Length	-	-	-	-	-	-	-	-	-	-	-	-
Veh in Median Storage, #	-	0	-	-	0	-	-	0	-	-	0	-
Grade, %	-	0	-	-	0	-	-	0	-	-	0	-
Peak Hour Factor	93	93	93	93	93	93	93	93	93	93	93	93
Heavy Vehicles, %	0	0	0	0	0	0	0	12	0	0	7	0
Mvmt Flow	14	0	6	10	1	13	1	225	8	16	451	9

Major/Minor	Minor2		Minor1		Major1		Major2					
Conflicting Flow All	731	733	459	729	733	238	463	0	0	240	0	0
Stage 1	491	491	-	238	238	-	-	-	-	-	-	-
Stage 2	240	242	-	491	495	-	-	-	-	-	-	-
Critical Hdwy	7.1	6.5	6.2	7.1	6.5	6.2	4.1	-	-	4.1	-	-
Critical Hdwy Stg 1	6.1	5.5	-	6.1	5.5	-	-	-	-	-	-	-
Critical Hdwy Stg 2	6.1	5.5	-	6.1	5.5	-	-	-	-	-	-	-
Follow-up Hdwy	3.5	4	3.3	3.5	4	3.3	2.2	-	-	2.2	-	-
Pot Cap-1 Maneuver	340	350	606	341	350	806	1109	-	-	1339	-	-
Stage 1	563	552	-	770	712	-	-	-	-	-	-	-
Stage 2	768	709	-	563	549	-	-	-	-	-	-	-
Platoon blocked, %								-	-	-	-	-
Mov Cap-1 Maneuver	328	341	604	331	341	799	1106	-	-	1330	-	-
Mov Cap-2 Maneuver	328	341	-	331	341	-	-	-	-	-	-	-
Stage 1	561	542	-	764	706	-	-	-	-	-	-	-
Stage 2	752	703	-	548	539	-	-	-	-	-	-	-

Approach	EB		WB		NB		SB	
HCM Control Delay, s	14.9		12.8		0		0.3	
HCM LOS	B		B					

Minor Lane/Major Mvmt	NBL	NBT	NBR	EBLn1	WBLn1	SBL	SBT	SBR
Capacity (veh/h)	1106	-	-	383	487	1330	-	-
HCM Lane V/C Ratio	0.001	-	-	0.053	0.049	0.012	-	-
HCM Control Delay (s)	8.3	0	-	14.9	12.8	7.7	0	-
HCM Lane LOS	A	A	-	B	B	A	A	-
HCM 95th %tile Q(veh)	0	-	-	0.2	0.2	0	-	-

Intersection						
Int Delay, s/veh	0.8					
Movement	WBL	WBR	NBT	NBR	SBL	SBT
Lane Configurations						
Traffic Vol, veh/h	33	4	188	14	6	446
Future Vol, veh/h	33	4	188	14	6	446
Conflicting Peds, #/hr	0	0	0	0	0	0
Sign Control	Stop	Stop	Free	Free	Free	Free
RT Channelized	-	None	-	None	-	None
Storage Length	0	-	-	-	-	-
Veh in Median Storage, #	0	-	0	-	-	0
Grade, %	0	-	0	-	-	0
Peak Hour Factor	95	95	95	95	95	95
Heavy Vehicles, %	3	0	14	7	50	6
Mvmt Flow	35	4	198	15	6	469

Major/Minor	Minor1	Major1	Major2		
Conflicting Flow All	687	206	0	0	213
Stage 1	206	-	-	-	-
Stage 2	481	-	-	-	-
Critical Hdwy	6.43	6.2	-	-	4.6
Critical Hdwy Stg 1	5.43	-	-	-	-
Critical Hdwy Stg 2	5.43	-	-	-	-
Follow-up Hdwy	3.527	3.3	-	-	2.65
Pot Cap-1 Maneuver	411	840	-	-	1118
Stage 1	826	-	-	-	-
Stage 2	620	-	-	-	-
Platoon blocked, %			-	-	-
Mov Cap-1 Maneuver	408	840	-	-	1118
Mov Cap-2 Maneuver	408	-	-	-	-
Stage 1	826	-	-	-	-
Stage 2	616	-	-	-	-

Approach	WB	NB	SB
HCM Control Delay, s	14.2	0	0.1
HCM LOS	B		

Minor Lane/Major Mvmt	NBT	NBRWBLn1	SBL	SBT
Capacity (veh/h)	-	-	432	1118
HCM Lane V/C Ratio	-	-	0.09	0.006
HCM Control Delay (s)	-	-	14.2	8.2
HCM Lane LOS	-	-	B	A
HCM 95th %tile Q(veh)	-	-	0.3	0

Intersection						
Int Delay, s/veh	4.7					
Movement	WBL	WBR	NBT	NBR	SBL	SBT
Lane Configurations						
Traffic Vol, veh/h	31	94	106	15	225	257
Future Vol, veh/h	31	94	106	15	225	257
Conflicting Peds, #/hr	0	0	0	0	0	0
Sign Control	Stop	Stop	Free	Free	Free	Free
RT Channelized	-	Yield	-	None	-	None
Storage Length	0	50	-	-	-	-
Veh in Median Storage, #	0	-	0	-	-	0
Grade, %	0	-	0	-	-	0
Peak Hour Factor	96	96	96	96	96	96
Heavy Vehicles, %	52	11	16	73	5	7
Mvmt Flow	32	98	110	16	234	268

















Major/Minor	Minor1	Major1	Major2			
Conflicting Flow All	854	118	0	0	126	0
Stage 1	118	-	-	-	-	-
Stage 2	736	-	-	-	-	-
Critical Hdwy	6.92	6.31	-	-	4.15	-
Critical Hdwy Stg 1	5.92	-	-	-	-	-
Critical Hdwy Stg 2	5.92	-	-	-	-	-
Follow-up Hdwy	3.968	3.399	-	-	2.245	-
Pot Cap-1 Maneuver	271	910	-	-	1442	-
Stage 1	797	-	-	-	-	-
Stage 2	395	-	-	-	-	-
Platoon blocked, %			-	-	-	-
Mov Cap-1 Maneuver	219	910	-	-	1442	-
Mov Cap-2 Maneuver	219	-	-	-	-	-
Stage 1	797	-	-	-	-	-
Stage 2	320	-	-	-	-	-

Approach	WB	NB	SB
HCM Control Delay, s	13.1	0	3.7
HCM LOS	B		

Minor Lane/Major Mvmt	NBT	NBRWBLn1WBLn2	SBL	SBT		
Capacity (veh/h)	-	-	219	910	1442	-
HCM Lane V/C Ratio	-	-	0.147	0.108	0.163	-
HCM Control Delay (s)	-	-	24.3	9.4	8	0
HCM Lane LOS	-	-	C	A	A	A
HCM 95th %tile Q(veh)	-	-	0.5	0.4	0.6	-

HCM Signalized Intersection Capacity Analysis
119-036; KSH Development

1: NY Route 211/Drwy & NY Route 17K
Existing 2019_PM Peak Hour

												
Movement	EBL	EBT	EBR	WBL	WBT	WBR	NBL	NBT	NBR	SBL	SBT	SBR
Lane Configurations												
Traffic Volume (vph)	2	282	124	117	495	0	310	1	130	1	1	2
Future Volume (vph)	2	282	124	117	495	0	310	1	130	1	1	2
Ideal Flow (vphpl)	1900	1900	1900	1900	1900	1900	1900	1900	1900	1900	1900	1900
Total Lost time (s)		5.0			5.0			5.0			5.0	
Lane Util. Factor		1.00			1.00			1.00			1.00	
Frbp, ped/bikes		1.00			1.00			0.99			1.00	
Flpb, ped/bikes		1.00			1.00			1.00			1.00	
Frt		0.96			1.00			0.96			0.93	
Flt Protected		1.00			0.99			0.97			0.99	
Satd. Flow (prot)		1787			1838			1729			1750	
Flt Permitted		1.00			0.84			0.79			0.94	
Satd. Flow (perm)		1785			1552			1412			1671	
Peak-hour factor, PHF	0.97	0.97	0.97	0.97	0.97	0.97	0.97	0.97	0.97	0.97	0.97	0.97
Adj. Flow (vph)	2	291	128	121	510	0	320	1	134	1	1	2
RTOR Reduction (vph)	0	12	0	0	0	0	0	16	0	0	1	0
Lane Group Flow (vph)	0	409	0	0	631	0	0	439	0	0	3	0
Confl. Peds. (#/hr)	7					7			1	1		
Heavy Vehicles (%)	0%	1%	4%	4%	2%	0%	1%	0%	2%	0%	0%	0%
Turn Type	Perm	NA		pm+pt	NA		Perm	NA		Perm	NA	
Protected Phases		1		2	5			3			3	
Permitted Phases	1			5			3			3		
Actuated Green, G (s)		44.1			44.1			29.8			29.8	
Effective Green, g (s)		44.1			44.1			29.8			29.8	
Actuated g/C Ratio		0.53			0.53			0.36			0.36	
Clearance Time (s)		5.0			5.0			5.0			5.0	
Vehicle Extension (s)		4.0			4.0			2.0			2.0	
Lane Grp Cap (vph)		938			815			501			593	
v/s Ratio Prot												
v/s Ratio Perm		0.23			c0.41			c0.31			0.00	
v/c Ratio		0.44			0.77			0.88			0.00	
Uniform Delay, d1		12.2			15.9			25.3			17.5	
Progression Factor		1.00			1.00			1.00			1.00	
Incremental Delay, d2		0.4			4.9			15.3			0.0	
Delay (s)		12.7			20.8			40.6			17.5	
Level of Service		B			C			D			B	
Approach Delay (s)		12.7			20.8			40.6			17.5	
Approach LOS		B			C			D			B	
Intersection Summary												
HCM 2000 Control Delay			24.5				HCM 2000 Level of Service			C		
HCM 2000 Volume to Capacity ratio			0.87									
Actuated Cycle Length (s)			83.9				Sum of lost time (s)		15.0			
Intersection Capacity Utilization			99.4%				ICU Level of Service		F			
Analysis Period (min)			15									

c Critical Lane Group

Intersection												
Int Delay, s/veh	0.5											
Movement	EBL	EBT	EBR	WBL	WBT	WBR	NBL	NBT	NBR	SBL	SBT	SBR
Lane Configurations		↕			↕			↕			↕	
Traffic Vol, veh/h	18	1	3	0	0	1	2	532	0	0	283	33
Future Vol, veh/h	18	1	3	0	0	1	2	532	0	0	283	33
Conflicting Peds, #/hr	1	0	0	0	0	1	4	0	3	3	0	4
Sign Control	Stop	Stop	Stop	Stop	Stop	Stop	Free	Free	Free	Free	Free	Free
RT Channelized	-	-	None	-	-	None	-	-	None	-	-	None
Storage Length	-	-	-	-	-	-	-	-	-	-	-	-
Veh in Median Storage, #	-	0	-	-	0	-	-	0	-	-	0	-
Grade, %	-	0	-	-	0	-	-	0	-	-	0	-
Peak Hour Factor	98	98	98	98	98	98	98	98	98	98	98	98
Heavy Vehicles, %	0	0	0	0	0	0	0	2	0	0	4	0
Mvmt Flow	18	1	3	0	0	1	2	543	0	0	289	34

Major/Minor	Minor2		Minor1		Major1			Major2				
Conflicting Flow All	859	860	310	858	877	547	327	0	0	546	0	0
Stage 1	310	310	-	550	550	-	-	-	-	-	-	-
Stage 2	549	550	-	308	327	-	-	-	-	-	-	-
Critical Hdwy	7.1	6.5	6.2	7.1	6.5	6.2	4.1	-	-	4.1	-	-
Critical Hdwy Stg 1	6.1	5.5	-	6.1	5.5	-	-	-	-	-	-	-
Critical Hdwy Stg 2	6.1	5.5	-	6.1	5.5	-	-	-	-	-	-	-
Follow-up Hdwy	3.5	4	3.3	3.5	4	3.3	2.2	-	-	2.2	-	-
Pot Cap-1 Maneuver	279	296	735	279	289	541	1244	-	-	1033	-	-
Stage 1	705	663	-	523	519	-	-	-	-	-	-	-
Stage 2	524	519	-	706	651	-	-	-	-	-	-	-
Platoon blocked, %								-	-	-	-	-
Mov Cap-1 Maneuver	277	293	732	276	286	539	1239	-	-	1030	-	-
Mov Cap-2 Maneuver	277	293	-	276	286	-	-	-	-	-	-	-
Stage 1	701	660	-	520	516	-	-	-	-	-	-	-
Stage 2	521	516	-	702	648	-	-	-	-	-	-	-

Approach	EB		WB		NB			SB		
HCM Control Delay, s	17.8		11.7		0			0		
HCM LOS	C		B							

Minor Lane/Major Mvmt	NBL	NBT	NBR	EBLn1	WBLn1	SBL	SBT	SBR
Capacity (veh/h)	1239	-	-	303	539	1030	-	-
HCM Lane V/C Ratio	0.002	-	-	0.074	0.002	-	-	-
HCM Control Delay (s)	7.9	0	-	17.8	11.7	0	-	-
HCM Lane LOS	A	A	-	C	B	A	-	-
HCM 95th %tile Q(veh)	0	-	-	0.2	0	0	-	-

Intersection						
Int Delay, s/veh	0.9					
Movement	WBL	WBR	NBT	NBR	SBL	SBT
Lane Configurations						
Traffic Vol, veh/h	27	12	506	39	13	250
Future Vol, veh/h	27	12	506	39	13	250
Conflicting Peds, #/hr	0	1	0	0	0	0
Sign Control	Stop	Stop	Free	Free	Free	Free
RT Channelized	-	None	-	None	-	None
Storage Length	0	-	-	-	-	-
Veh in Median Storage, #	0	-	0	-	-	0
Grade, %	0	-	0	-	-	0
Peak Hour Factor	92	92	92	92	92	92
Heavy Vehicles, %	4	0	2	0	8	4
Mvmt Flow	29	13	550	42	14	272

Major/Minor	Minor1	Major1	Major2		
Conflicting Flow All	871	572	0	0	592
Stage 1	571	-	-	-	-
Stage 2	300	-	-	-	-
Critical Hdwy	6.44	6.2	-	-	4.18
Critical Hdwy Stg 1	5.44	-	-	-	-
Critical Hdwy Stg 2	5.44	-	-	-	-
Follow-up Hdwy	3.536	3.3	-	-	2.272
Pot Cap-1 Maneuver	319	523	-	-	955
Stage 1	561	-	-	-	-
Stage 2	747	-	-	-	-
Platoon blocked, %					
Mov Cap-1 Maneuver	314	523	-	-	955
Mov Cap-2 Maneuver	314	-	-	-	-
Stage 1	561	-	-	-	-
Stage 2	734	-	-	-	-

Approach	WB	NB	SB
HCM Control Delay, s	16.4	0	0.4
HCM LOS	C		

Minor Lane/Major Mvmt	NBT	NBRWBLn1	SBL	SBT
Capacity (veh/h)	-	-	358	955
HCM Lane V/C Ratio	-	-	0.118	0.015
HCM Control Delay (s)	-	-	16.4	8.8
HCM Lane LOS	-	-	C	A
HCM 95th %tile Q(veh)	-	-	0.4	0

Intersection						
Int Delay, s/veh	4.3					
Movement	WBL	WBR	NBT	NBR	SBL	SBT
Lane Configurations						
Traffic Vol, veh/h	11	211	336	15	88	189
Future Vol, veh/h	11	211	336	15	88	189
Conflicting Peds, #/hr	0	0	0	0	0	0
Sign Control	Stop	Stop	Free	Free	Free	Free
RT Channelized	-	Yield	-	None	-	None
Storage Length	0	50	-	-	-	-
Veh in Median Storage, #	0	-	0	-	-	0
Grade, %	0	-	0	-	-	0
Peak Hour Factor	93	93	93	93	93	93
Heavy Vehicles, %	36	3	1	20	8	2
Mvmt Flow	12	227	361	16	95	203

















Major/Minor	Minor1	Major1	Major2		
Conflicting Flow All	762	369	0	0	377
Stage 1	369	-	-	-	-
Stage 2	393	-	-	-	-
Critical Hdwy	6.76	6.23	-	-	4.18
Critical Hdwy Stg 1	5.76	-	-	-	-
Critical Hdwy Stg 2	5.76	-	-	-	-
Follow-up Hdwy	3.824	3.327	-	-	2.272
Pot Cap-1 Maneuver	328	674	-	-	1149
Stage 1	631	-	-	-	-
Stage 2	614	-	-	-	-
Platoon blocked, %			-	-	-
Mov Cap-1 Maneuver	297	674	-	-	1149
Mov Cap-2 Maneuver	297	-	-	-	-
Stage 1	631	-	-	-	-
Stage 2	557	-	-	-	-

Approach	WB	NB	SB
HCM Control Delay, s	13.2	0	2.7
HCM LOS	B		

Minor Lane/Major Mvmt	NBT	NBRWBLn1	WBLn2	SBL	SBT
Capacity (veh/h)	-	-	297	674	1149
HCM Lane V/C Ratio	-	-	0.04	0.337	0.082
HCM Control Delay (s)	-	-	17.6	13	8.4
HCM Lane LOS	-	-	C	B	A
HCM 95th %tile Q(veh)	-	-	0.1	1.5	0.3

HCM Signalized Intersection Capacity Analysis
119-036; KSH Development

1: NY Route 211/Drwy & NY Route 17K
No-Build 2025_AM Peak Hour

												
Movement	EBL	EBT	EBR	WBL	WBT	WBR	NBL	NBT	NBR	SBL	SBT	SBR
Lane Configurations												
Traffic Volume (vph)	0	570	267	128	184	0	134	1	98	1	3	1
Future Volume (vph)	0	570	267	128	184	0	134	1	98	1	3	1
Ideal Flow (vphpl)	1900	1900	1900	1900	1900	1900	1900	1900	1900	1900	1900	1900
Total Lost time (s)		5.0			5.0			5.0			5.0	
Lane Util. Factor		1.00			1.00			1.00			1.00	
Frbp, ped/bikes		1.00			1.00			1.00			1.00	
Flpb, ped/bikes		1.00			1.00			1.00			1.00	
Frt		0.96			1.00			0.94			0.97	
Flt Protected		1.00			0.98			0.97			0.99	
Satd. Flow (prot)		1731			1650			1580			1830	
Flt Permitted		1.00			0.44			0.82			0.95	
Satd. Flow (perm)		1731			742			1332			1758	
Peak-hour factor, PHF	0.97	0.97	0.97	0.97	0.97	0.97	0.97	0.97	0.97	0.97	0.97	0.97
Adj. Flow (vph)	0	588	275	132	190	0	138	1	101	1	3	1
RTOR Reduction (vph)	0	22	0	0	0	0	0	28	0	0	1	0
Lane Group Flow (vph)	0	841	0	0	322	0	0	212	0	0	4	0
Confl. Peds. (#/hr)	4					4						
Heavy Vehicles (%)	0%	6%	3%	14%	12%	0%	12%	0%	8%	0%	0%	0%
Turn Type		NA		pm+pt	NA		Perm	NA		Perm	NA	
Protected Phases		1		2	5			3			3	
Permitted Phases	1			5			3			3		
Actuated Green, G (s)		36.2			36.2			10.3			10.3	
Effective Green, g (s)		36.2			36.2			10.3			10.3	
Actuated g/C Ratio		0.64			0.64			0.18			0.18	
Clearance Time (s)		5.0			5.0			5.0			5.0	
Vehicle Extension (s)		4.0			4.0			2.0			2.0	
Lane Grp Cap (vph)	1109				475			242			320	
v/s Ratio Prot		c0.49										
v/s Ratio Perm					0.43			c0.16			0.00	
v/c Ratio		0.76			0.68			0.88			0.01	
Uniform Delay, d1		7.1			6.4			22.5			18.9	
Progression Factor		1.00			1.00			1.00			1.00	
Incremental Delay, d2		3.2			4.2			27.2			0.0	
Delay (s)		10.3			10.6			49.7			18.9	
Level of Service		B			B			D			B	
Approach Delay (s)		10.3			10.6			49.7			18.9	
Approach LOS		B			B			D			B	
Intersection Summary												
HCM 2000 Control Delay			17.0				HCM 2000 Level of Service			B		
HCM 2000 Volume to Capacity ratio			0.88									
Actuated Cycle Length (s)			56.5				Sum of lost time (s)		15.0			
Intersection Capacity Utilization			95.7%				ICU Level of Service		F			
Analysis Period (min)			15									

c Critical Lane Group

Intersection												
Int Delay, s/veh	1											
Movement	EBL	EBT	EBR	WBL	WBT	WBR	NBL	NBT	NBR	SBL	SBT	SBR
Lane Configurations		↕			↕			↕			↕	
Traffic Vol, veh/h	14	0	6	11	1	13	1	255	8	16	497	8
Future Vol, veh/h	14	0	6	11	1	13	1	255	8	16	497	8
Conflicting Peds, #/hr	2	0	0	0	0	2	3	0	7	7	0	3
Sign Control	Stop	Stop	Stop	Stop	Stop	Stop	Free	Free	Free	Free	Free	Free
RT Channelized	-	-	None	-	-	None	-	-	None	-	-	None
Storage Length	-	-	-	-	-	-	-	-	-	-	-	-
Veh in Median Storage, #	-	0	-	-	0	-	-	0	-	-	0	-
Grade, %	-	0	-	-	0	-	-	0	-	-	0	-
Peak Hour Factor	93	93	93	93	93	93	93	93	93	93	93	93
Heavy Vehicles, %	0	0	0	0	0	0	0	12	0	0	7	0
Mvmt Flow	15	0	6	12	1	14	1	274	9	17	534	9

Major/Minor	Minor2		Minor1		Major1		Major2					
Conflicting Flow All	866	868	542	864	868	288	546	0	0	290	0	0
Stage 1	576	576	-	288	288	-	-	-	-	-	-	-
Stage 2	290	292	-	576	580	-	-	-	-	-	-	-
Critical Hdwy	7.1	6.5	6.2	7.1	6.5	6.2	4.1	-	-	4.1	-	-
Critical Hdwy Stg 1	6.1	5.5	-	6.1	5.5	-	-	-	-	-	-	-
Critical Hdwy Stg 2	6.1	5.5	-	6.1	5.5	-	-	-	-	-	-	-
Follow-up Hdwy	3.5	4	3.3	3.5	4	3.3	2.2	-	-	2.2	-	-
Pot Cap-1 Maneuver	276	293	544	277	293	756	1033	-	-	1283	-	-
Stage 1	506	505	-	724	677	-	-	-	-	-	-	-
Stage 2	722	675	-	506	503	-	-	-	-	-	-	-
Platoon blocked, %								-	-	-	-	-
Mov Cap-1 Maneuver	265	284	542	268	284	750	1030	-	-	1274	-	-
Mov Cap-2 Maneuver	265	284	-	268	284	-	-	-	-	-	-	-
Stage 1	504	494	-	718	672	-	-	-	-	-	-	-
Stage 2	705	670	-	490	492	-	-	-	-	-	-	-

Approach	EB		WB		NB		SB	
HCM Control Delay, s	17.3		14.5		0		0.2	
HCM LOS	C		B					

Minor Lane/Major Mvmt	NBL	NBT	NBR	EBLn1	WBLn1	SBL	SBT	SBR
Capacity (veh/h)	1030	-	-	313	404	1274	-	-
HCM Lane V/C Ratio	0.001	-	-	0.069	0.067	0.014	-	-
HCM Control Delay (s)	8.5	0	-	17.3	14.5	7.9	0	-
HCM Lane LOS	A	A	-	C	B	A	A	-
HCM 95th %tile Q(veh)	0	-	-	0.2	0.2	0	-	-

Intersection						
Int Delay, s/veh	1.5					
Movement	WBL	WBR	NBT	NBR	SBL	SBT
Lane Configurations						
Traffic Vol, veh/h	50	23	215	20	11	521
Future Vol, veh/h	50	23	215	20	11	521
Conflicting Peds, #/hr	0	0	0	0	0	0
Sign Control	Stop	Stop	Free	Free	Free	Free
RT Channelized	-	None	-	None	-	None
Storage Length	0	-	-	-	-	-
Veh in Median Storage, #	0	-	0	-	-	0
Grade, %	0	-	0	-	-	0
Peak Hour Factor	95	95	95	95	95	95
Heavy Vehicles, %	3	0	14	7	50	6
Mvmt Flow	53	24	226	21	12	548

Major/Minor	Minor1	Major1	Major2		
Conflicting Flow All	809	237	0	0	247
Stage 1	237	-	-	-	-
Stage 2	572	-	-	-	-
Critical Hdwy	6.43	6.2	-	-	4.6
Critical Hdwy Stg 1	5.43	-	-	-	-
Critical Hdwy Stg 2	5.43	-	-	-	-
Follow-up Hdwy	3.527	3.3	-	-	2.65
Pot Cap-1 Maneuver	348	807	-	-	1084
Stage 1	800	-	-	-	-
Stage 2	563	-	-	-	-
Platoon blocked, %					
Mov Cap-1 Maneuver	342	807	-	-	1084
Mov Cap-2 Maneuver	342	-	-	-	-
Stage 1	800	-	-	-	-
Stage 2	554	-	-	-	-

Approach	WB	NB	SB
HCM Control Delay, s	15.5	0	0.2
HCM LOS	C		

Minor Lane/Major Mvmt	NBT	NBRWBLn1	SBL	SBT
Capacity (veh/h)	-	-	418	1084
HCM Lane V/C Ratio	-	-	0.184	0.011
HCM Control Delay (s)	-	-	15.5	8.4
HCM Lane LOS	-	-	C	A
HCM 95th %tile Q(veh)	-	-	0.7	0

Intersection						
Int Delay, s/veh	5.5					
Movement	WBL	WBR	NBT	NBR	SBL	SBT
Lane Configurations						
Traffic Vol, veh/h	33	141	149	16	291	302
Future Vol, veh/h	33	141	149	16	291	302
Conflicting Peds, #/hr	0	0	0	0	0	0
Sign Control	Stop	Stop	Free	Free	Free	Free
RT Channelized	-	Yield	-	None	-	None
Storage Length	0	50	-	-	-	-
Veh in Median Storage, #	0	-	0	-	-	0
Grade, %	0	-	0	-	-	0
Peak Hour Factor	96	96	96	96	96	96
Heavy Vehicles, %	52	11	16	73	5	7
Mvmt Flow	34	147	155	17	303	315

Major/Minor	Minor1	Major1	Major2			
Conflicting Flow All	1085	164	0	0	172	0
Stage 1	164	-	-	-	-	-
Stage 2	921	-	-	-	-	-
Critical Hdwy	6.92	6.31	-	-	4.15	-
Critical Hdwy Stg 1	5.92	-	-	-	-	-
Critical Hdwy Stg 2	5.92	-	-	-	-	-
Follow-up Hdwy	3.968	3.399	-	-	2.245	-
Pot Cap-1 Maneuver	193	858	-	-	1387	-
Stage 1	757	-	-	-	-	-
Stage 2	318	-	-	-	-	-
Platoon blocked, %			-	-		-
Mov Cap-1 Maneuver	142	858	-	-	1387	-
Mov Cap-2 Maneuver	142	-	-	-	-	-
Stage 1	757	-	-	-	-	-
Stage 2	234	-	-	-	-	-

Approach	WB	NB	SB
HCM Control Delay, s	15.4	0	4.1
HCM LOS	C		

Minor Lane/Major Mvmt	NBT	NBRWBLn1	WBLn2	SBL	SBT
Capacity (veh/h)	-	-	142	858	1387
HCM Lane V/C Ratio	-	-	0.242	0.171	0.219
HCM Control Delay (s)	-	-	38.3	10.1	8.3
HCM Lane LOS	-	-	E	B	A
HCM 95th %tile Q(veh)	-	-	0.9	0.6	0.8

HCM Signalized Intersection Capacity Analysis
119-036; KSH Development

1: NY Route 211/Drwy & NY Route 17K
No-Build 2025_PM Peak Hour



Movement	EBL	EBT	EBR	WBL	WBT	WBR	NBL	NBT	NBR	SBL	SBT	SBR
Lane Configurations		↕			↕			↕			↕	
Traffic Volume (vph)	2	344	152	143	534	0	372	1	174	1	1	2
Future Volume (vph)	2	344	152	143	534	0	372	1	174	1	1	2
Ideal Flow (vphpl)	1900	1900	1900	1900	1900	1900	1900	1900	1900	1900	1900	1900
Total Lost time (s)		5.0			5.0			5.0			5.0	
Lane Util. Factor		1.00			1.00			1.00			1.00	
Frbp, ped/bikes		1.00			1.00			0.99			1.00	
Flpb, ped/bikes		1.00			1.00			1.00			1.00	
Frt		0.96			1.00			0.96			0.93	
Flt Protected		1.00			0.99			0.97			0.99	
Satd. Flow (prot)		1787			1836			1724			1750	
Flt Permitted		1.00			0.74			0.79			0.94	
Satd. Flow (perm)		1785			1381			1416			1665	
Peak-hour factor, PHF	0.97	0.97	0.97	0.97	0.97	0.97	0.97	0.97	0.97	0.97	0.97	0.97
Adj. Flow (vph)	2	355	157	147	551	0	384	1	179	1	1	2
RTOR Reduction (vph)	0	12	0	0	0	0	0	18	0	0	1	0
Lane Group Flow (vph)	0	502	0	0	698	0	0	546	0	0	3	0
Confl. Peds. (#/hr)	7					7			1	1		
Heavy Vehicles (%)	0%	1%	4%	4%	2%	0%	1%	0%	2%	0%	0%	0%
Turn Type	Perm	NA		pm+pt	NA		Perm	NA		Perm	NA	
Protected Phases		1		2	5			3			3	
Permitted Phases	1			5			3			3		
Actuated Green, G (s)		50.0			50.0			35.0			35.0	
Effective Green, g (s)		50.0			50.0			35.0			35.0	
Actuated g/C Ratio		0.53			0.53			0.37			0.37	
Clearance Time (s)		5.0			5.0			5.0			5.0	
Vehicle Extension (s)		4.0			4.0			2.0			2.0	
Lane Grp Cap (vph)		939			726			521			613	
v/s Ratio Prot												
v/s Ratio Perm		0.28			c0.51			c0.39			0.00	
v/c Ratio		0.53			0.96			1.05			0.00	
Uniform Delay, d1		14.8			21.6			30.0			19.0	
Progression Factor		1.00			1.00			1.00			1.00	
Incremental Delay, d2		0.7			24.3			52.8			0.0	
Delay (s)		15.6			45.9			82.8			19.0	
Level of Service		B			D			F			B	
Approach Delay (s)		15.6			45.9			82.8			19.0	
Approach LOS		B			D			F			B	

Intersection Summary			
HCM 2000 Control Delay	48.8	HCM 2000 Level of Service	D
HCM 2000 Volume to Capacity ratio	1.06		
Actuated Cycle Length (s)	95.0	Sum of lost time (s)	15.0
Intersection Capacity Utilization	114.0%	ICU Level of Service	H
Analysis Period (min)	15		

c Critical Lane Group

Intersection												
Int Delay, s/veh	0.5											
Movement	EBL	EBT	EBR	WBL	WBT	WBR	NBL	NBT	NBR	SBL	SBT	SBR
Lane Configurations		↕			↕			↕			↕	
Traffic Vol, veh/h	20	1	3	0	0	1	2	632	0	0	347	35
Future Vol, veh/h	20	1	3	0	0	1	2	632	0	0	347	35
Conflicting Peds, #/hr	1	0	0	0	0	1	4	0	3	3	0	4
Sign Control	Stop	Stop	Stop	Stop	Stop	Stop	Free	Free	Free	Free	Free	Free
RT Channelized	-	-	None	-	-	None	-	-	None	-	-	None
Storage Length	-	-	-	-	-	-	-	-	-	-	-	-
Veh in Median Storage, #	-	0	-	-	0	-	-	0	-	-	0	-
Grade, %	-	0	-	-	0	-	-	0	-	-	0	-
Peak Hour Factor	98	98	98	98	98	98	98	98	98	98	98	98
Heavy Vehicles, %	0	0	0	0	0	0	0	2	0	0	4	0
Mvmt Flow	20	1	3	0	0	1	2	645	0	0	354	36

Major/Minor	Minor2		Minor1		Major1		Major2					
Conflicting Flow All	1027	1028	376	1026	1046	649	394	0	0	648	0	0
Stage 1	376	376	-	652	652	-	-	-	-	-	-	-
Stage 2	651	652	-	374	394	-	-	-	-	-	-	-
Critical Hdwy	7.1	6.5	6.2	7.1	6.5	6.2	4.1	-	-	4.1	-	-
Critical Hdwy Stg 1	6.1	5.5	-	6.1	5.5	-	-	-	-	-	-	-
Critical Hdwy Stg 2	6.1	5.5	-	6.1	5.5	-	-	-	-	-	-	-
Follow-up Hdwy	3.5	4	3.3	3.5	4	3.3	2.2	-	-	2.2	-	-
Pot Cap-1 Maneuver	215	236	675	215	230	473	1176	-	-	947	-	-
Stage 1	649	620	-	460	467	-	-	-	-	-	-	-
Stage 2	461	467	-	651	609	-	-	-	-	-	-	-
Platoon blocked, %								-	-	-	-	-
Mov Cap-1 Maneuver	213	234	672	212	228	471	1172	-	-	944	-	-
Mov Cap-2 Maneuver	213	234	-	212	228	-	-	-	-	-	-	-
Stage 1	644	618	-	457	464	-	-	-	-	-	-	-
Stage 2	458	464	-	647	607	-	-	-	-	-	-	-

Approach	EB		WB		NB		SB	
HCM Control Delay, s	22.2		12.7		0		0	
HCM LOS	C		B					

Minor Lane/Major Mvmt	NBL	NBT	NBR	EBLn1	WBLn1	SBL	SBT	SBR
Capacity (veh/h)	1172	-	-	234	471	944	-	-
HCM Lane V/C Ratio	0.002	-	-	0.105	0.002	-	-	-
HCM Control Delay (s)	8.1	0	-	22.2	12.7	0	-	-
HCM Lane LOS	A	A	-	C	B	A	-	-
HCM 95th %tile Q(veh)	0	-	-	0.3	0	0	-	-

Intersection						
Int Delay, s/veh	1.9					
Movement	WBL	WBR	NBT	NBR	SBL	SBT
Lane Configurations						
Traffic Vol, veh/h	48	30	593	47	29	291
Future Vol, veh/h	48	30	593	47	29	291
Conflicting Peds, #/hr	0	1	0	0	0	0
Sign Control	Stop	Stop	Free	Free	Free	Free
RT Channelized	-	None	-	None	-	None
Storage Length	0	-	-	-	-	-
Veh in Median Storage, #	0	-	0	-	-	0
Grade, %	0	-	0	-	-	0
Peak Hour Factor	92	92	92	92	92	92
Heavy Vehicles, %	4	0	2	0	8	4
Mvmt Flow	52	33	645	51	32	316

Major/Minor	Minor1	Major1	Major2		
Conflicting Flow All	1051	672	0	0	696
Stage 1	671	-	-	-	-
Stage 2	380	-	-	-	-
Critical Hdwy	6.44	6.2	-	-	4.18
Critical Hdwy Stg 1	5.44	-	-	-	-
Critical Hdwy Stg 2	5.44	-	-	-	-
Follow-up Hdwy	3.536	3.3	-	-	2.272
Pot Cap-1 Maneuver	249	459	-	-	873
Stage 1	504	-	-	-	-
Stage 2	687	-	-	-	-
Platoon blocked, %					
Mov Cap-1 Maneuver	238	459	-	-	873
Mov Cap-2 Maneuver	238	-	-	-	-
Stage 1	504	-	-	-	-
Stage 2	657	-	-	-	-

Approach	WB	NB	SB
HCM Control Delay, s	22.3	0	0.8
HCM LOS	C		

Minor Lane/Major Mvmt	NBT	NBRWBLn1	SBL	SBT
Capacity (veh/h)	-	-	292	873
HCM Lane V/C Ratio	-	-	0.29	0.036
HCM Control Delay (s)	-	-	22.3	9.3
HCM Lane LOS	-	-	C	A
HCM 95th %tile Q(veh)	-	-	1.2	0.1

Intersection						
Int Delay, s/veh	5.2					
Movement	WBL	WBR	NBT	NBR	SBL	SBT
Lane Configurations						
Traffic Vol, veh/h	12	265	396	16	140	260
Future Vol, veh/h	12	265	396	16	140	260
Conflicting Peds, #/hr	0	0	0	0	0	0
Sign Control	Stop	Stop	Free	Free	Free	Free
RT Channelized	-	Yield	-	None	-	None
Storage Length	0	50	-	-	-	-
Veh in Median Storage, #	0	-	0	-	-	0
Grade, %	0	-	0	-	-	0
Peak Hour Factor	93	93	93	93	93	93
Heavy Vehicles, %	36	3	1	20	8	2
Mvmt Flow	13	285	426	17	151	280

Major/Minor	Minor1	Major1	Major2		
Conflicting Flow All	1017	435	0	0	443
Stage 1	435	-	-	-	-
Stage 2	582	-	-	-	-
Critical Hdwy	6.76	6.23	-	-	4.18
Critical Hdwy Stg 1	5.76	-	-	-	-
Critical Hdwy Stg 2	5.76	-	-	-	-
Follow-up Hdwy	3.824	3.327	-	-	2.272
Pot Cap-1 Maneuver	228	619	-	-	1086
Stage 1	586	-	-	-	-
Stage 2	497	-	-	-	-
Platoon blocked, %			-	-	-
Mov Cap-1 Maneuver	190	619	-	-	1086
Mov Cap-2 Maneuver	190	-	-	-	-
Stage 1	586	-	-	-	-
Stage 2	415	-	-	-	-

Approach	WB	NB	SB
HCM Control Delay, s	16.1	0	3.1
HCM LOS	C		

Minor Lane/Major Mvmt	NBT	NBRWBLn1	WBLn2	SBL	SBT
Capacity (veh/h)	-	-	190	619	1086
HCM Lane V/C Ratio	-	-	0.068	0.46	0.139
HCM Control Delay (s)	-	-	25.3	15.7	8.8
HCM Lane LOS	-	-	D	C	A
HCM 95th %tile Q(veh)	-	-	0.2	2.4	0.5



Movement	EBL	EBT	EBR	WBL	WBT	WBR	NBL	NBT	NBR	SBL	SBT	SBR
Lane Configurations		↕			↕			↕			↕	
Traffic Volume (vph)	0	570	281	163	184	0	138	1	107	1	3	1
Future Volume (vph)	0	570	281	163	184	0	138	1	107	1	3	1
Ideal Flow (vphpl)	1900	1900	1900	1900	1900	1900	1900	1900	1900	1900	1900	1900
Total Lost time (s)		5.0			5.0			5.0			5.0	
Lane Util. Factor		1.00			1.00			1.00			1.00	
Frb, ped/bikes		1.00			1.00			1.00			1.00	
Flpb, ped/bikes		1.00			1.00			1.00			1.00	
Frt		0.96			1.00			0.94			0.97	
Flt Protected		1.00			0.98			0.97			0.99	
Satd. Flow (prot)		1729			1680			1616			1830	
Flt Permitted		1.00			0.39			0.82			0.95	
Satd. Flow (perm)		1729			669			1368			1755	
Peak-hour factor, PHF	0.97	0.97	0.97	0.97	0.97	0.97	0.97	0.97	0.97	0.97	0.97	0.97
Adj. Flow (vph)	0	588	290	168	190	0	142	1	110	1	3	1
RTOR Reduction (vph)	0	20	0	0	0	0	0	30	0	0	1	0
Lane Group Flow (vph)	0	858	0	0	358	0	0	223	0	0	4	0
Confl. Peds. (#/hr)	4					4						
Heavy Vehicles (%)	0%	6%	3%	10%	11%	0%	9%	0%	6%	0%	0%	0%
Turn Type		NA		pm+pt	NA		Perm	NA		Perm	NA	
Protected Phases		1		2	5			3			3	
Permitted Phases	1			5			3			3		
Actuated Green, G (s)		44.5			44.5			10.4			10.4	
Effective Green, g (s)		44.5			44.5			10.4			10.4	
Actuated g/C Ratio		0.69			0.69			0.16			0.16	
Clearance Time (s)		5.0			5.0			5.0			5.0	
Vehicle Extension (s)		4.0			4.0			2.0			2.0	
Lane Grp Cap (vph)		1185			458			219			281	
v/s Ratio Prot		0.50										
v/s Ratio Perm					c0.54			c0.16			0.00	
v/c Ratio		0.72			0.78			1.02			0.01	
Uniform Delay, d1		6.4			6.9			27.3			22.9	
Progression Factor		1.00			1.00			1.00			1.00	
Incremental Delay, d2		2.4			8.9			65.3			0.0	
Delay (s)		8.7			15.8			92.6			22.9	
Level of Service		A			B			F			C	
Approach Delay (s)		8.7			15.8			92.6			22.9	
Approach LOS		A			B			F			C	

Intersection Summary

HCM 2000 Control Delay	24.7	HCM 2000 Level of Service	C
HCM 2000 Volume to Capacity ratio	0.91		
Actuated Cycle Length (s)	64.9	Sum of lost time (s)	15.0
Intersection Capacity Utilization	99.2%	ICU Level of Service	F
Analysis Period (min)	15		

c Critical Lane Group

Intersection												
Int Delay, s/veh	1											
Movement	EBL	EBT	EBR	WBL	WBT	WBR	NBL	NBT	NBR	SBL	SBT	SBR
Lane Configurations		↕			↕			↕			↕	
Traffic Vol, veh/h	14	0	6	11	1	13	1	268	8	16	546	8
Future Vol, veh/h	14	0	6	11	1	13	1	268	8	16	546	8
Conflicting Peds, #/hr	2	0	0	0	0	2	3	0	7	7	0	3
Sign Control	Stop	Stop	Stop	Stop	Stop	Stop	Free	Free	Free	Free	Free	Free
RT Channelized	-	-	None	-	-	None	-	-	None	-	-	None
Storage Length	-	-	-	-	-	-	-	-	-	-	-	-
Veh in Median Storage, #	-	0	-	-	0	-	-	0	-	-	0	-
Grade, %	-	0	-	-	0	-	-	0	-	-	0	-
Peak Hour Factor	93	93	93	93	93	93	93	93	93	93	93	93
Heavy Vehicles, %	0	0	0	0	0	0	0	1	0	0	6	0
Mvmt Flow	15	0	6	12	1	14	1	288	9	17	587	9

Major/Minor	Minor2		Minor1		Major1		Major2					
Conflicting Flow All	933	935	595	931	935	302	599	0	0	304	0	0
Stage 1	629	629	-	302	302	-	-	-	-	-	-	-
Stage 2	304	306	-	629	633	-	-	-	-	-	-	-
Critical Hdwy	7.1	6.5	6.2	7.1	6.5	6.2	4.1	-	-	4.1	-	-
Critical Hdwy Stg 1	6.1	5.5	-	6.1	5.5	-	-	-	-	-	-	-
Critical Hdwy Stg 2	6.1	5.5	-	6.1	5.5	-	-	-	-	-	-	-
Follow-up Hdwy	3.5	4	3.3	3.5	4	3.3	2.2	-	-	2.2	-	-
Pot Cap-1 Maneuver	248	267	508	249	267	742	988	-	-	1268	-	-
Stage 1	474	478	-	712	668	-	-	-	-	-	-	-
Stage 2	710	665	-	474	476	-	-	-	-	-	-	-
Platoon blocked, %								-	-	-	-	-
Mov Cap-1 Maneuver	238	259	507	240	259	736	985	-	-	1260	-	-
Mov Cap-2 Maneuver	238	259	-	240	259	-	-	-	-	-	-	-
Stage 1	472	467	-	706	663	-	-	-	-	-	-	-
Stage 2	693	660	-	459	465	-	-	-	-	-	-	-

Approach	EB		WB		NB		SB	
HCM Control Delay, s	18.8		15.5		0		0.2	
HCM LOS	C		C					

Minor Lane/Major Mvmt	NBL	NBT	NBR	EBLn1	WBLn1	SBL	SBT	SBR
Capacity (veh/h)	985	-	-	283	371	1260	-	-
HCM Lane V/C Ratio	0.001	-	-	0.076	0.072	0.014	-	-
HCM Control Delay (s)	8.7	0	-	18.8	15.5	7.9	0	-
HCM Lane LOS	A	A	-	C	C	A	A	-
HCM 95th %tile Q(veh)	0	-	-	0.2	0.2	0	-	-

Intersection												
Int Delay, s/veh	2.8											
Movement	EBL	EBT	EBR	WBL	WBT	WBR	NBL	NBT	NBR	SBL	SBT	SBR
Lane Configurations		↕			↕			↕			↕	
Traffic Vol, veh/h	13	0	17	50	0	23	49	215	20	11	521	49
Future Vol, veh/h	13	0	17	50	0	23	49	215	20	11	521	49
Conflicting Peds, #/hr	0	0	0	0	0	0	0	0	0	0	0	0
Sign Control	Stop	Stop	Stop	Stop	Stop	Stop	Free	Free	Free	Free	Free	Free
RT Channelized	-	-	None	-	-	None	-	-	None	-	-	None
Storage Length	-	-	-	-	-	-	-	-	-	-	-	-
Veh in Median Storage, #	-	0	-	-	0	-	-	0	-	-	0	-
Grade, %	-	0	-	-	0	-	-	0	-	-	0	-
Peak Hour Factor	95	95	95	95	95	95	95	95	95	95	95	95
Heavy Vehicles, %	0	0	24	2	0	0	0	12	5	27	5	2
Mvmt Flow	14	0	18	53	0	24	52	226	21	12	548	52

Major/Minor	Minor2		Minor1		Major1			Major2				
Conflicting Flow All	951	949	574	948	965	237	600	0	0	247	0	0
Stage 1	598	598	-	341	341	-	-	-	-	-	-	-
Stage 2	353	351	-	607	624	-	-	-	-	-	-	-
Critical Hdwy	7.1	6.5	6.44	7.12	6.5	6.2	4.1	-	-	4.37	-	-
Critical Hdwy Stg 1	6.1	5.5	-	6.12	5.5	-	-	-	-	-	-	-
Critical Hdwy Stg 2	6.1	5.5	-	6.12	5.5	-	-	-	-	-	-	-
Follow-up Hdwy	3.5	4	3.516	3.518	4	3.3	2.2	-	-	2.443	-	-
Pot Cap-1 Maneuver	242	262	479	241	257	807	987	-	-	1186	-	-
Stage 1	492	494	-	674	642	-	-	-	-	-	-	-
Stage 2	668	636	-	483	481	-	-	-	-	-	-	-
Platoon blocked, %								-	-	-	-	-
Mov Cap-1 Maneuver	221	242	479	219	238	807	987	-	-	1186	-	-
Mov Cap-2 Maneuver	221	242	-	219	238	-	-	-	-	-	-	-
Stage 1	462	487	-	633	603	-	-	-	-	-	-	-
Stage 2	608	597	-	458	474	-	-	-	-	-	-	-

Approach	EB		WB		NB		SB	
HCM Control Delay, s	17.6		22.3		1.5		0.2	
HCM LOS	C		C					

Minor Lane/Major Mvmt	NBL	NBT	NBR	EBLn1WBLn1	SBL	SBT	SBR
Capacity (veh/h)	987	-	-	318	284	1186	-
HCM Lane V/C Ratio	0.052	-	-	0.099	0.271	0.01	-
HCM Control Delay (s)	8.8	0	-	17.6	22.3	8.1	0
HCM Lane LOS	A	A	-	C	C	A	A
HCM 95th %tile Q(veh)	0.2	-	-	0.3	1.1	0	-

Intersection						
Int Delay, s/veh	5.5					
Movement	WBL	WBR	NBT	NBR	SBL	SBT
Lane Configurations						
Traffic Vol, veh/h	33	155	184	16	297	313
Future Vol, veh/h	33	155	184	16	297	313
Conflicting Peds, #/hr	0	0	0	0	0	0
Sign Control	Stop	Stop	Free	Free	Free	Free
RT Channelized	-	Yield	-	None	-	None
Storage Length	0	50	-	-	-	-
Veh in Median Storage, #	0	-	0	-	-	0
Grade, %	0	-	0	-	-	0
Peak Hour Factor	96	96	96	96	96	96
Heavy Vehicles, %	49	6	10	69	4	6
Mvmt Flow	34	161	192	17	309	326

Major/Minor	Minor1	Major1	Major2		
Conflicting Flow All	1145	201	0	0	209
Stage 1	201	-	-	-	-
Stage 2	944	-	-	-	-
Critical Hdwy	6.89	6.26	-	-	4.14
Critical Hdwy Stg 1	5.89	-	-	-	-
Critical Hdwy Stg 2	5.89	-	-	-	-
Follow-up Hdwy	3.941	3.354	-	-	2.236
Pot Cap-1 Maneuver	179	830	-	-	1350
Stage 1	732	-	-	-	-
Stage 2	313	-	-	-	-
Platoon blocked, %			-	-	-
Mov Cap-1 Maneuver	129	830	-	-	1350
Mov Cap-2 Maneuver	129	-	-	-	-
Stage 1	732	-	-	-	-
Stage 2	225	-	-	-	-

Approach	WB	NB	SB
HCM Control Delay, s	16.1	0	4.1
HCM LOS	C		

Minor Lane/Major Mvmt	NBT	NBRWBLn1	WBLn2	SBL	SBT
Capacity (veh/h)	-	-	129	830	1350
HCM Lane V/C Ratio	-	-	0.266	0.195	0.229
HCM Control Delay (s)	-	-	42.8	10.4	8.5
HCM Lane LOS	-	-	E	B	A
HCM 95th %tile Q(veh)	-	-	1	0.7	0.9

HCM Signalized Intersection Capacity Analysis
119-036; KSH Development

1: NY Route 211/Drwy & NY Route 17K
Build 2025_PM Peak Hour



Movement	EBL	EBT	EBR	WBL	WBT	WBR	NBL	NBT	NBR	SBL	SBT	SBR
Lane Configurations		↕			↕			↕			↕	
Traffic Volume (vph)	2	344	158	156	534	0	387	1	208	1	1	2
Future Volume (vph)	2	344	158	156	534	0	387	1	208	1	1	2
Ideal Flow (vphpl)	1900	1900	1900	1900	1900	1900	1900	1900	1900	1900	1900	1900
Total Lost time (s)		5.0			5.0			5.0			5.0	
Lane Util. Factor		1.00			1.00			1.00			1.00	
Frbp, ped/bikes		1.00			1.00			0.99			1.00	
Flpb, ped/bikes		1.00			1.00			1.00			1.00	
Frt		0.96			1.00			0.95			0.93	
Flt Protected		1.00			0.99			0.97			0.99	
Satd. Flow (prot)		1785			1834			1717			1750	
Flt Permitted		1.00			0.72			0.80			0.94	
Satd. Flow (perm)		1782			1330			1421			1658	
Peak-hour factor, PHF	0.97	0.97	0.97	0.97	0.97	0.97	0.97	0.97	0.97	0.97	0.97	0.97
Adj. Flow (vph)	2	355	163	161	551	0	399	1	214	1	1	2
RTOR Reduction (vph)	0	13	0	0	0	0	0	20	0	0	1	0
Lane Group Flow (vph)	0	507	0	0	712	0	0	594	0	0	3	0
Confl. Peds. (#/hr)	7					7			1	1		
Heavy Vehicles (%)	0%	1%	4%	4%	2%	0%	1%	0%	2%	0%	0%	0%
Turn Type	Perm	NA		pm+pt	NA		Perm	NA		Perm	NA	
Protected Phases		1		2	5			3			3	
Permitted Phases	1			5			3			3		
Actuated Green, G (s)		50.0			50.0			35.0			35.0	
Effective Green, g (s)		50.0			50.0			35.0			35.0	
Actuated g/C Ratio		0.53			0.53			0.37			0.37	
Clearance Time (s)		5.0			5.0			5.0			5.0	
Vehicle Extension (s)		4.0			4.0			2.0			2.0	
Lane Grp Cap (vph)		937			700			523			610	
v/s Ratio Prot												
v/s Ratio Perm		0.28			c0.54			c0.42			0.00	
v/c Ratio		0.54			1.02			1.14			0.00	
Uniform Delay, d1		14.9			22.5			30.0			19.0	
Progression Factor		1.00			1.00			1.00			1.00	
Incremental Delay, d2		0.8			38.4			82.3			0.0	
Delay (s)		15.7			60.9			112.3			19.0	
Level of Service		B			E			F			B	
Approach Delay (s)		15.7			60.9			112.3			19.0	
Approach LOS		B			E			F			B	
Intersection Summary												
HCM 2000 Control Delay			65.2				HCM 2000 Level of Service			E		
HCM 2000 Volume to Capacity ratio			1.13									
Actuated Cycle Length (s)			95.0				Sum of lost time (s)		15.0			
Intersection Capacity Utilization			118.0%				ICU Level of Service		H			
Analysis Period (min)			15									

c Critical Lane Group

Intersection												
Int Delay, s/veh	0.5											
Movement	EBL	EBT	EBR	WBL	WBT	WBR	NBL	NBT	NBR	SBL	SBT	SBR
Lane Configurations		↕			↕			↕			↕	
Traffic Vol, veh/h	20	1	3	0	0	1	2	681	0	0	366	35
Future Vol, veh/h	20	1	3	0	0	1	2	681	0	0	366	35
Conflicting Peds, #/hr	1	0	0	0	0	1	4	0	3	3	0	4
Sign Control	Stop	Stop	Stop	Stop	Stop	Stop	Free	Free	Free	Free	Free	Free
RT Channelized	-	-	None	-	-	None	-	-	None	-	-	None
Storage Length	-	-	-	-	-	-	-	-	-	-	-	-
Veh in Median Storage, #	-	0	-	-	0	-	-	0	-	-	0	-
Grade, %	-	0	-	-	0	-	-	0	-	-	0	-
Peak Hour Factor	98	98	98	98	98	98	98	98	98	98	98	98
Heavy Vehicles, %	0	0	0	0	0	0	0	1	0	0	4	0
Mvmt Flow	20	1	3	0	0	1	2	695	0	0	373	36

Major/Minor	Minor2		Minor1		Major1			Major2				
Conflicting Flow All	1096	1097	395	1095	1115	699	413	0	0	698	0	0
Stage 1	395	395	-	702	702	-	-	-	-	-	-	-
Stage 2	701	702	-	393	413	-	-	-	-	-	-	-
Critical Hdwy	7.1	6.5	6.2	7.1	6.5	6.2	4.1	-	-	4.1	-	-
Critical Hdwy Stg 1	6.1	5.5	-	6.1	5.5	-	-	-	-	-	-	-
Critical Hdwy Stg 2	6.1	5.5	-	6.1	5.5	-	-	-	-	-	-	-
Follow-up Hdwy	3.5	4	3.3	3.5	4	3.3	2.2	-	-	2.2	-	-
Pot Cap-1 Maneuver	193	215	659	193	210	443	1157	-	-	908	-	-
Stage 1	634	608	-	432	443	-	-	-	-	-	-	-
Stage 2	433	443	-	636	597	-	-	-	-	-	-	-
Platoon blocked, %								-	-	-	-	-
Mov Cap-1 Maneuver	191	213	656	190	208	441	1153	-	-	905	-	-
Mov Cap-2 Maneuver	191	213	-	190	208	-	-	-	-	-	-	-
Stage 1	630	606	-	429	440	-	-	-	-	-	-	-
Stage 2	430	440	-	632	595	-	-	-	-	-	-	-

Approach	EB		WB		NB		SB	
HCM Control Delay, s	24.3		13.2		0		0	
HCM LOS	C		B					

Minor Lane/Major Mvmt	NBL	NBT	NBR	EBLn1	WBLn1	SBL	SBT	SBR
Capacity (veh/h)	1153	-	-	211	441	905	-	-
HCM Lane V/C Ratio	0.002	-	-	0.116	0.002	-	-	-
HCM Control Delay (s)	8.1	0	-	24.3	13.2	0	-	-
HCM Lane LOS	A	A	-	C	B	A	-	-
HCM 95th %tile Q(veh)	0	-	-	0.4	0	0	-	-

Intersection												
Int Delay, s/veh	4.5											
Movement	EBL	EBT	EBR	WBL	WBT	WBR	NBL	NBT	NBR	SBL	SBT	SBR
Lane Configurations		↕			↕			↕			↕	
Traffic Vol, veh/h	49	0	53	48	0	30	19	593	47	29	291	19
Future Vol, veh/h	49	0	53	48	0	30	19	593	47	29	291	19
Conflicting Peds, #/hr	0	0	0	0	0	0	0	0	0	0	0	0
Sign Control	Stop	Stop	Stop	Stop	Stop	Stop	Free	Free	Free	Free	Free	Free
RT Channelized	-	-	None	-	-	None	-	-	None	-	-	None
Storage Length	-	-	-	-	-	-	-	-	-	-	-	-
Veh in Median Storage, #	-	0	-	-	0	-	-	0	-	-	0	-
Grade, %	-	0	-	-	0	-	-	0	-	-	0	-
Peak Hour Factor	95	95	95	95	95	95	95	95	95	95	95	95
Heavy Vehicles, %	0	0	8	2	0	0	11	1	0	3	4	11
Mvmt Flow	52	0	56	51	0	32	20	624	49	31	306	20

Major/Minor	Minor2		Minor1		Major1			Major2				
Conflicting Flow All	1083	1091	316	1095	1077	649	326	0	0	673	0	0
Stage 1	378	378	-	689	689	-	-	-	-	-	-	-
Stage 2	705	713	-	406	388	-	-	-	-	-	-	-
Critical Hdwy	7.1	6.5	6.28	7.12	6.5	6.2	4.21	-	-	4.13	-	-
Critical Hdwy Stg 1	6.1	5.5	-	6.12	5.5	-	-	-	-	-	-	-
Critical Hdwy Stg 2	6.1	5.5	-	6.12	5.5	-	-	-	-	-	-	-
Follow-up Hdwy	3.5	4	3.372	3.518	4	3.3	2.299	-	-	2.227	-	-
Pot Cap-1 Maneuver	197	217	711	191	221	473	1185	-	-	913	-	-
Stage 1	648	619	-	436	450	-	-	-	-	-	-	-
Stage 2	430	438	-	622	612	-	-	-	-	-	-	-
Platoon blocked, %								-	-	-	-	-
Mov Cap-1 Maneuver	174	202	711	167	206	473	1185	-	-	913	-	-
Mov Cap-2 Maneuver	174	202	-	167	206	-	-	-	-	-	-	-
Stage 1	631	593	-	424	438	-	-	-	-	-	-	-
Stage 2	390	426	-	549	586	-	-	-	-	-	-	-

Approach	EB		WB		NB		SB	
HCM Control Delay, s	25		30.4		0.2		0.8	
HCM LOS	D		D					

Minor Lane/Major Mvmt	NBL	NBT	NBR	EBLn1WBLn1	SBL	SBT	SBR
Capacity (veh/h)	1185	-	-	286	222	913	-
HCM Lane V/C Ratio	0.017	-	-	0.375	0.37	0.033	-
HCM Control Delay (s)	8.1	0	-	25	30.4	9.1	0
HCM Lane LOS	A	A	-	D	D	A	A
HCM 95th %tile Q(veh)	0.1	-	-	1.7	1.6	0.1	-

Intersection						
Int Delay, s/veh	5.1					
Movement	WBL	WBR	NBT	NBR	SBL	SBT
Lane Configurations						
Traffic Vol, veh/h	12	271	409	16	157	296
Future Vol, veh/h	12	271	409	16	157	296
Conflicting Peds, #/hr	0	0	0	0	0	0
Sign Control	Stop	Stop	Free	Free	Free	Free
RT Channelized	-	Yield	-	None	-	None
Storage Length	0	50	-	-	-	-
Veh in Median Storage, #	0	-	0	-	-	0
Grade, %	0	-	0	-	-	0
Peak Hour Factor	96	96	96	96	96	96
Heavy Vehicles, %	33	3	1	19	6	2
Mvmt Flow	13	282	426	17	164	308

Major/Minor	Minor1	Major1	Major2		
Conflicting Flow All	1071	435	0	0	443
Stage 1	435	-	-	-	-
Stage 2	636	-	-	-	-
Critical Hdwy	6.73	6.23	-	-	4.16
Critical Hdwy Stg 1	5.73	-	-	-	-
Critical Hdwy Stg 2	5.73	-	-	-	-
Follow-up Hdwy	3.797	3.327	-	-	2.254
Pot Cap-1 Maneuver	214	619	-	-	1096
Stage 1	592	-	-	-	-
Stage 2	473	-	-	-	-
Platoon blocked, %			-	-	-
Mov Cap-1 Maneuver	175	619	-	-	1096
Mov Cap-2 Maneuver	175	-	-	-	-
Stage 1	592	-	-	-	-
Stage 2	387	-	-	-	-

Approach	WB	NB	SB
HCM Control Delay, s	16.1	0	3.1
HCM LOS	C		

Minor Lane/Major Mvmt	NBT	NBRWBLn1	WBLn2	SBL	SBT
Capacity (veh/h)	-	-	175	619	1096
HCM Lane V/C Ratio	-	-	0.071	0.456	0.149
HCM Control Delay (s)	-	-	27.1	15.6	8.9
HCM Lane LOS	-	-	D	C	A
HCM 95th %tile Q(veh)	-	-	0.2	2.4	0.5

Attachment D

Signal Warrant Analysis

**Traffic Impact Assessment
KSH Development
Village of Montgomery, New York**

NYS Route 211/Chandler Ln/Site Driveway (No-Build Conditions)
Figure 4C-2
Reduced Four-Hour Vehicular Volume Warrant
Source: Federal MUTCD

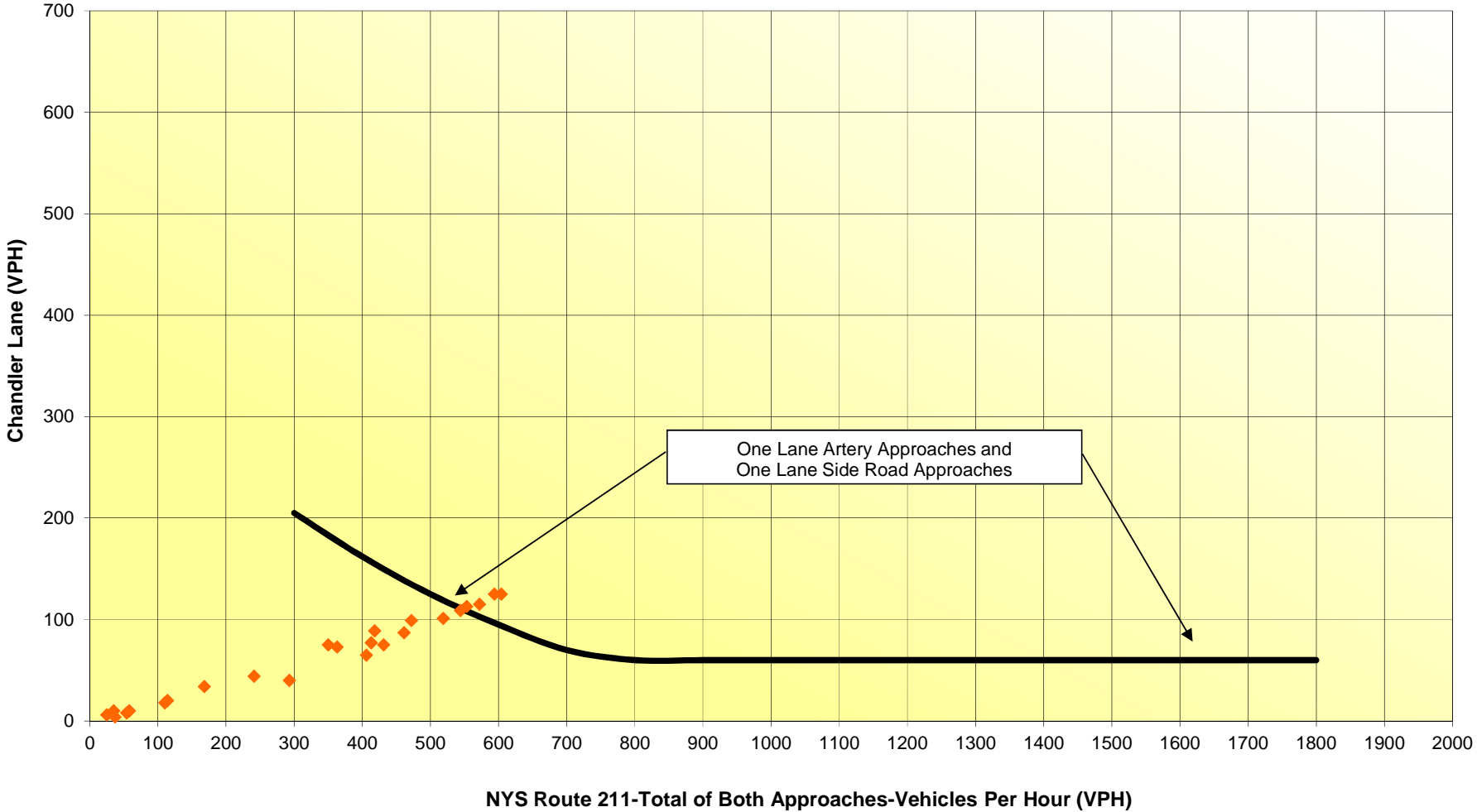

**NYS Route 211/Chandler Ln/Site Driveway (No-Build Conditions
Figure 4C-4
Reduced Peak Hour Volume Warrant
Source: Federal MUTCD**

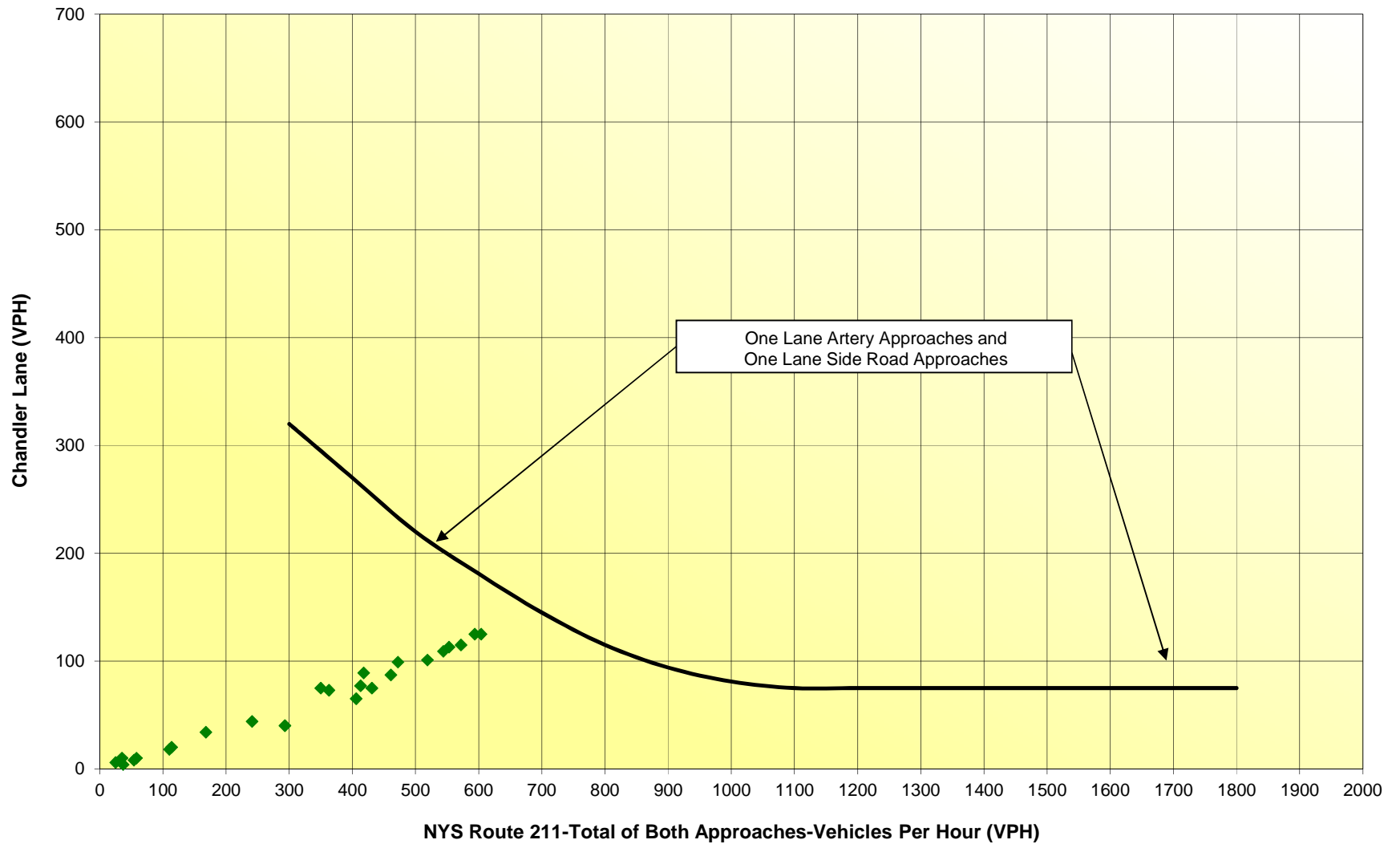



Project:		119-036; KSH Development																																	
Intersection:		NYS Route 211/Chandler Lane - BUILD																																	
Date:		4/13/2022																																	
Analyst:		SWH																																	
Select your lane configuration		Main 1, Side 1																																	
		3																																	
		100% (a)				Warrant 1, A				70%(c)				56% (d)				100%(a)				Warrant 1, B				70%(c)				56%(d)					
		500				80% (b)				350				280				750				80%(b)				525				420					
		150				120				105				84				75				60				53				42					
Add your volumes																																			
Hour	NYS	Chandler	Site	Condition A												Condition B																			
Beginning	211	Lane	Driveway	100%				80%				70%				56%				100%				80%				70%				56%			
				Main	SS 1	SS 2	Overall	Main	SS 1	SS 2	Overall	Main	SS 1	SS 2	Overall	Main	SS 1	SS 2	Overall	Main	SS 1	SS 2	Overall	Main	SS 1	SS 2	Overall	Main	SS 1	SS 2	Overall				
12:00 AM	58	10	1																																
1:00 AM	35	10	2																																
2:00 AM	26	6	2																																
3:00 AM	40	4	2																																
4:00 AM	59	8	6																																
5:00 AM	121	18	8																																
6:00 AM	317	40	9													Y																			
7:00 AM	427	65	16					Y				Y				Y				Y				Y	Y			Y	Y		1				
8:00 AM	451	75	16					Y				Y				Y				Y			Y	Y			Y	Y		1					
9:00 AM	443	77	18					Y				Y				Y				Y			Y	Y			Y	Y		1					
10:00 AM	438	89	22					Y				Y	Y		1	Y				Y			Y	Y			Y	Y		1					
11:00 AM	498	99	25					Y				Y	Y		1	Y				Y			Y	Y			Y	Y		1					
12:00 PM	572	109	20	Y				Y	Y		1	Y	Y		1	Y				Y	Y		1	Y	Y		1	Y	Y		1				
1:00 PM	541	101	18	Y				Y				Y	Y		1	Y				Y			Y	Y		1	Y	Y		1					
2:00 PM	575	113	18	Y				Y	Y		1	Y	Y		1	Y				Y	Y		1	Y	Y		1	Y	Y		1				
3:00 PM	618	125	30	Y		Y		Y	Y		1	Y	Y		1	Y				Y	Y		1	Y	Y		1	Y	Y		1				
4:00 PM	621	125	25	Y		Y		Y	Y		1	Y	Y		1	Y				Y	Y		1	Y	Y		1	Y	Y		1				
5:00 PM	585	115	22	Y		Y		Y	Y		1	Y	Y		1	Y				Y	Y		1	Y	Y		1	Y	Y		1				
6:00 PM	466	87	13					Y				Y	Y		1	Y				Y			Y	Y			Y	Y		1					
7:00 PM	366	73	4									Y				Y				Y			Y	Y			Y	Y							
8:00 PM	354	75	3									Y				Y				Y			Y	Y			Y	Y							
9:00 PM	242	44	9													Y							Y	Y			Y	Y							
10:00 PM	171	34	1																																
11:00 PM	115	20	2																																
		Hours Met		0				2				5				9				0				2				6				12			
		Required		8				8				8				8				8				8				8							
		Warrant Met?		No				No				No				Yes				No				No				Yes							
NOTES:																																			
(a) Basic minimum hourly volume.																																			
(b) Used for combination of Conditions A and B after adequate trial of other remedial measures.																																			
(c) May be used when the major-street speed exceeds 40 mph or in an isolated community with a population of less than 10,000.																																			
(d) May be used for combination of Conditions A and B after adequate trial of other remedial measures when the major street speed exceeds 40 mph or in an isolated community with a population of less than 10,000.																																			
Reference:	Federal Manual on Uniform Traffic Control Devices for Streets and Highways (MUTCD), 2009 Edition New York State Supplement to the MUTCD																																		
Checked:	FMP on 04/14/2022																																		

NYS Route 211/Chandler Ln/Site Driveway (Build Conditions)

Figure 4C-2

Reduced Four-Hour Vehicular Volume Warrant

Source: Federal MUTCD

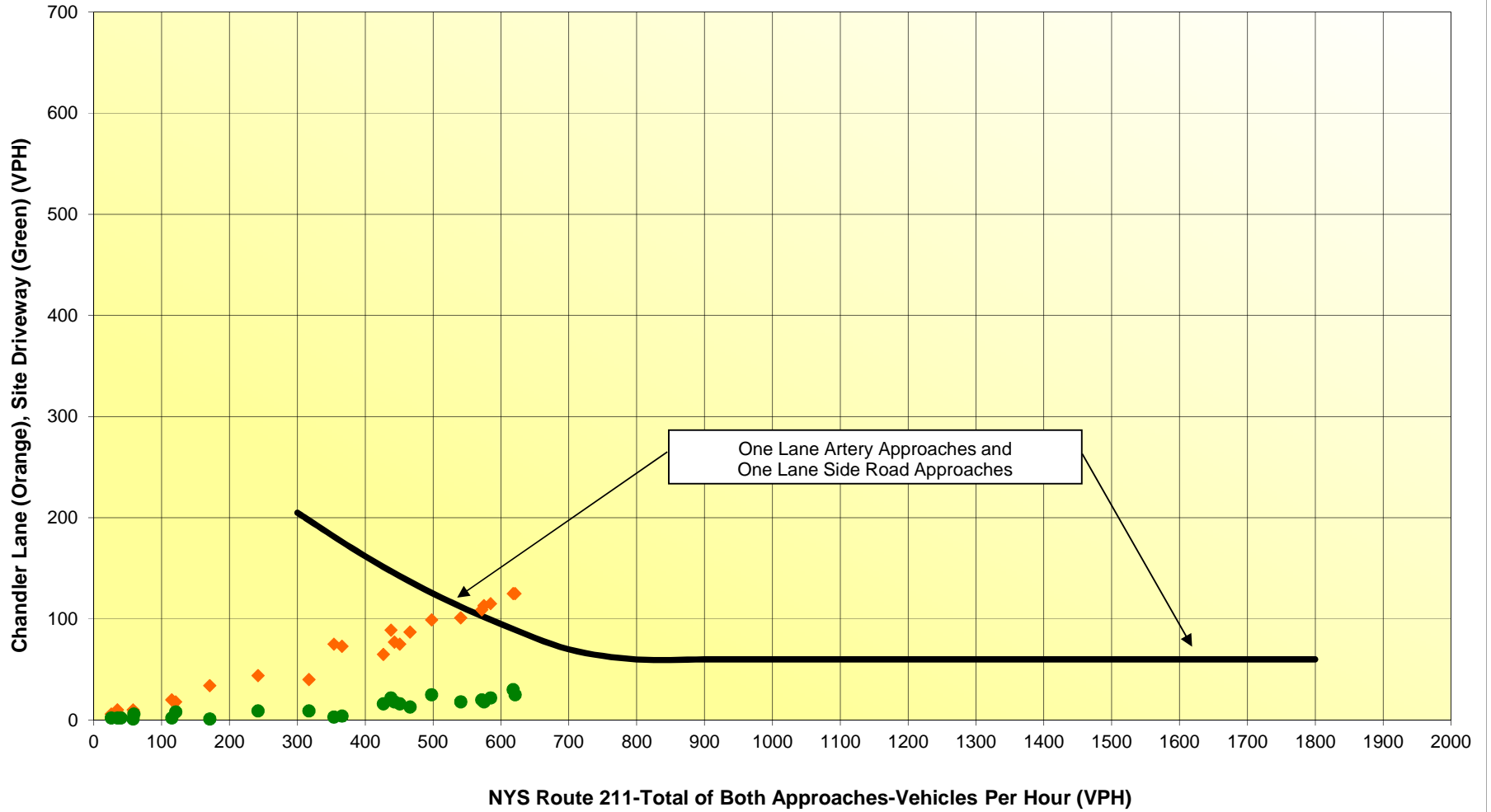

NYS Route 211/Chandler Ln/Site Driveway (Build Conditions)

Figure 4C-4

Reduced Peak Hour Volume Warrant

Source: Federal MUTCD

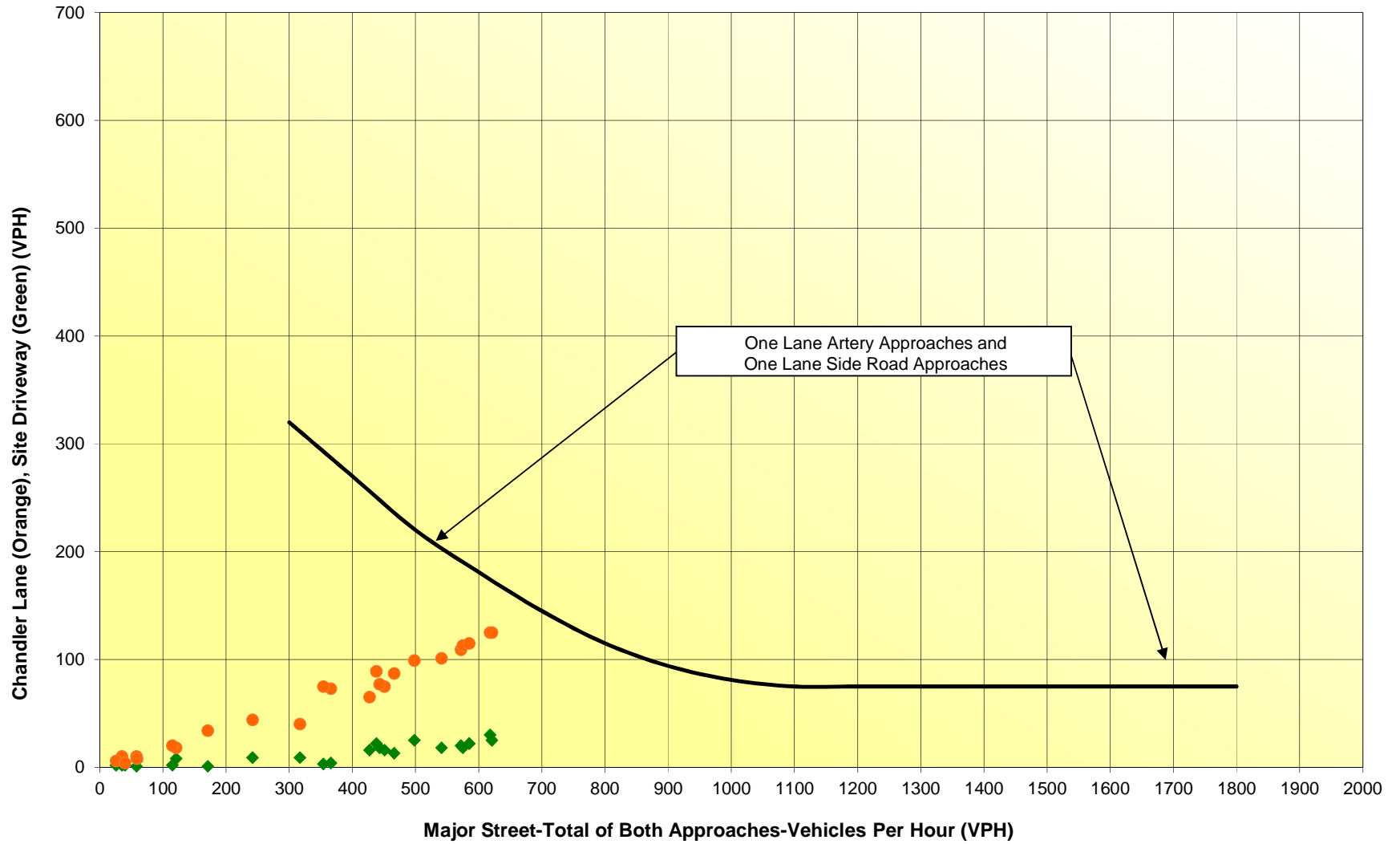



Project:		119-036; KSH Development																																
Intersection:		NYS Route 211/NYS Route 416 - NO-BUILD																																
Date:		4/8/2022																																
Analyst:		SWH																																
Select your lane configuration		Main 1, Side 2																																
		Warrant 1, A				Warrant 1, B																												
		100% (a)				80% (b)				70% (c)				56% (d)				100% (a)				80% (b)				70% (c)				56% (d)				
		500				400				350				280				750				600				525				420				
		200				160				140				112				100				80				70				56				
Add your volumes																																		
Hour	NYS	NYS	Condition A												Condition B																			
Beginning	211	416	100%				80%				70%				56%				100%				80%				70%				56%			
			Main	SS 1	SS 2	Overall	Main	SS 1	SS 2	Overall	Main	SS 1	SS 2	Overall	Main	SS 1	SS 2	Overall	Main	SS 1	SS 2	Overall	Main	SS 1	SS 2	Overall	Main	SS 1	SS 2	Overall				
12:00 AM	35	18																																
1:00 AM	26	17																																
2:00 AM	28	27																																
3:00 AM	33	23																																
4:00 AM	54	71																																
5:00 AM	94	82																																
6:00 AM	233	177						Y				Y				Y				Y				Y				Y				Y		
7:00 AM	436	296		Y			Y	Y		1	Y	Y		1	Y	Y		1	Y	Y		1	Y	Y		1	Y	Y		1				
8:00 AM	520	238	Y	Y		1	Y	Y		1	Y	Y		1	Y	Y		1	Y	Y		1	Y	Y		1	Y	Y		1				
9:00 AM	439	167		Y			Y	Y		1	Y	Y		1	Y	Y		1	Y	Y		1	Y	Y		1	Y	Y		1				
10:00 AM	417	120		Y			Y	Y		1	Y	Y		1	Y	Y		1	Y	Y		1	Y	Y		1	Y	Y		1				
11:00 AM	445	126		Y			Y	Y		1	Y	Y		1	Y	Y		1	Y	Y		1	Y	Y		1	Y	Y		1				
12:00 PM	470	135		Y			Y	Y		1	Y	Y		1	Y	Y		1	Y	Y		1	Y	Y		1	Y	Y		1				
1:00 PM	478	142		Y			Y	Y		1	Y	Y		1	Y	Y		1	Y	Y		1	Y	Y		1	Y	Y		1				
2:00 PM	531	145	Y				Y	Y		1	Y	Y		1	Y	Y		1	Y	Y		1	Y	Y		1	Y	Y		1				
3:00 PM	599	178	Y				Y	Y		1	Y	Y		1	Y	Y		1	Y	Y		1	Y	Y		1	Y	Y		1				
4:00 PM	634	152	Y				Y	Y		1	Y	Y		1	Y	Y		1	Y	Y		1	Y	Y		1	Y	Y		1				
5:00 PM	607	134	Y				Y	Y		1	Y	Y		1	Y	Y		1	Y	Y		1	Y	Y		1	Y	Y		1				
6:00 PM	408	90		Y			Y				Y				Y				Y				Y				Y							
7:00 PM	301	61																																
8:00 PM	220	54																																
9:00 PM	140	32																																
10:00 PM	92	37																																
11:00 PM	74	23																																
			Hours Met				4				7				11				0				2				4				10			
			Required				8				8				8				8				8				8							
			Warrant Met?				No				No				Yes				No				No				Yes							
NOTES:																																		
(a) Basic minimum hourly volume.																																		
(b) Used for combination of Conditions A and B after adequate trial of other remedial measures.																																		
(c) May be used when the major-street speed exceeds 40 mph or in an isolated community with a population of less than 10,000.																																		
(d) May be used for combination of Conditions A and B after adequate trial of other remedial measures when the major street speed exceeds 40 mph or in an isolated community with a population of less than 10,000.																																		
Reference:	Federal Manual on Uniform Traffic Control Devices for Streets and Highways (MUTCD), 2009 Edition New York State Supplement to the MUTCD																																	
Checked:	FMP on 04/14/2022																																	

NYS Route 211/NYS Route 416 (No-Build Conditions)
Figure 4C-2
Reduced Four-Hour Vehicular Volume Warrant
Source: Federal MUTCD

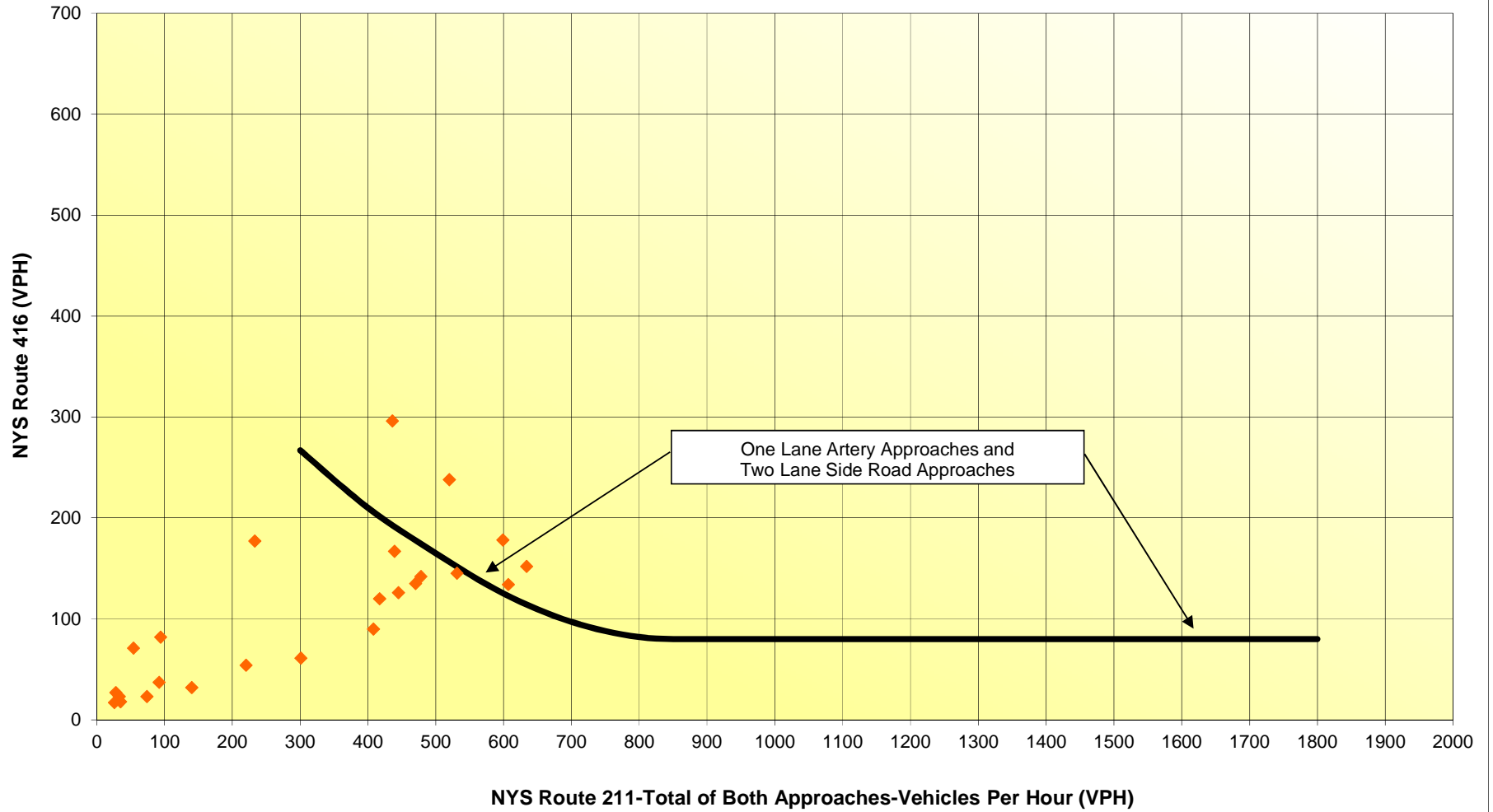

NYS Route 211/NYS Route 416 (No-Build Conditions)
Figure 4C-4
Reduced Peak Hour Volume Warrant (No-Build)
Source: Federal MUTCD

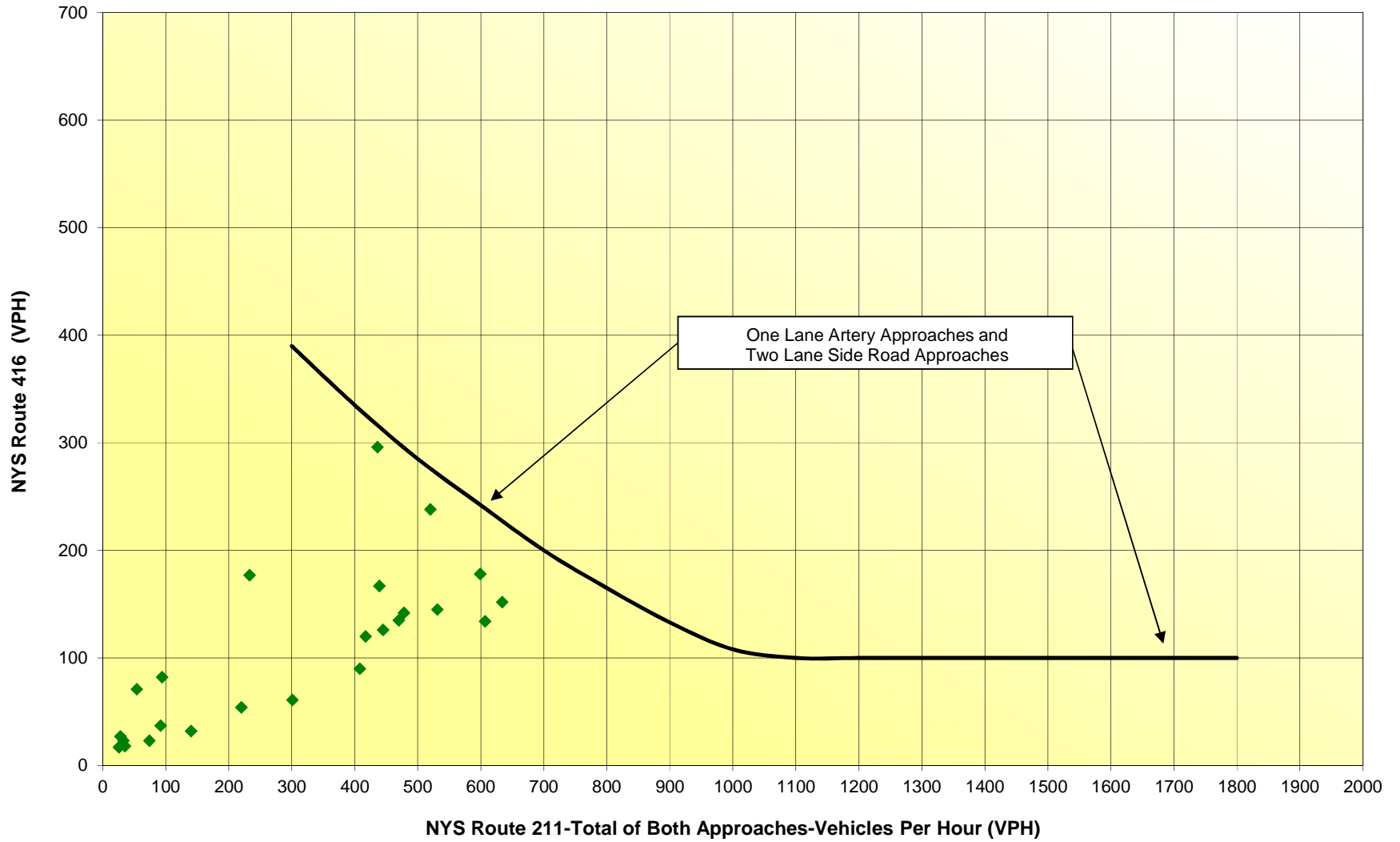

NYS Route 211/NYS Route 416 (Build Conditions)
Figure 4C-2
Reduced Four-Hour Vehicular Volume Warrant
Source: Federal MUTCD

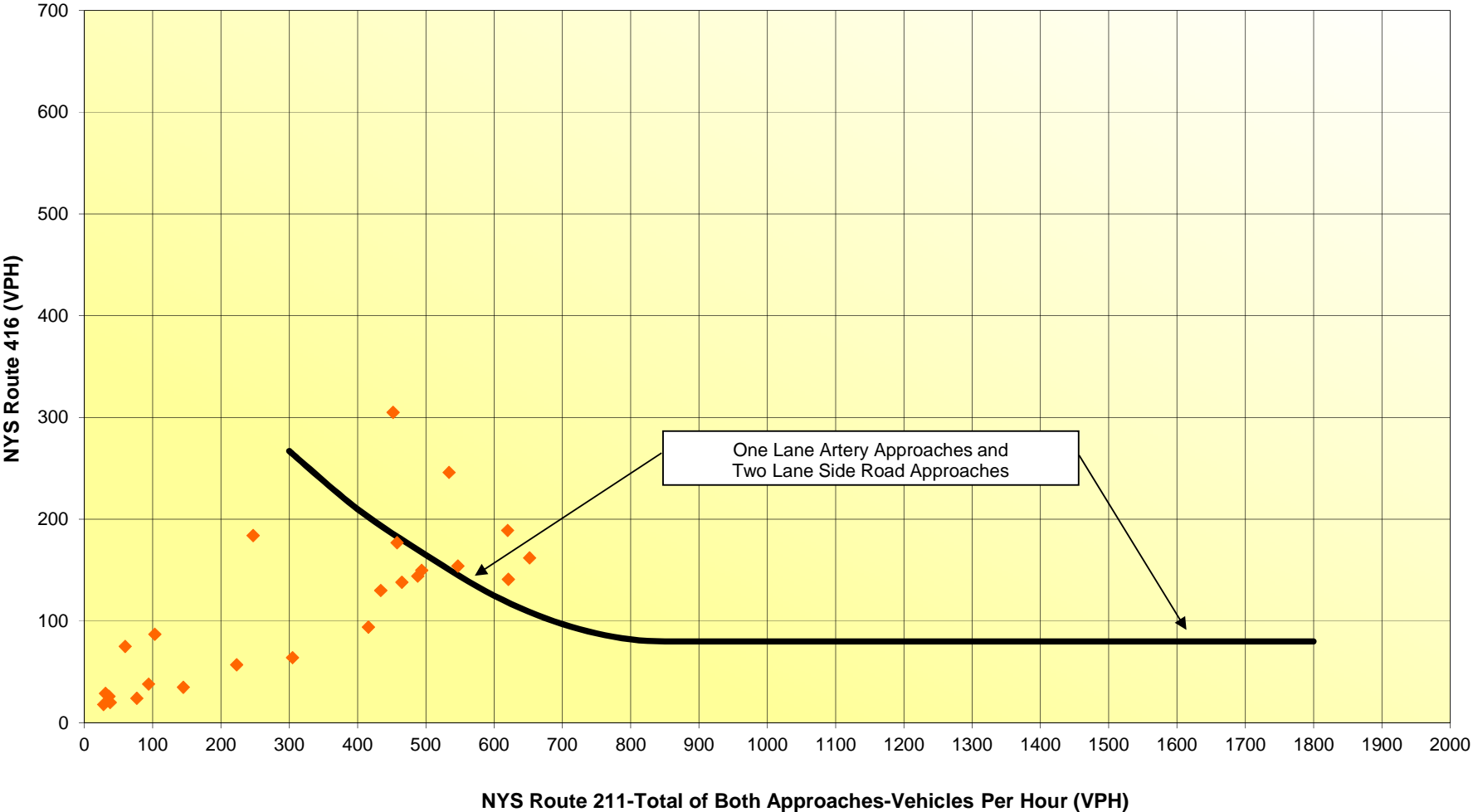

NYS Route 211/NYS Route 416 (Build Conditions)
Figure 4C-4
Reduced Peak Hour Volume Warrant Source: Federal MUTCD

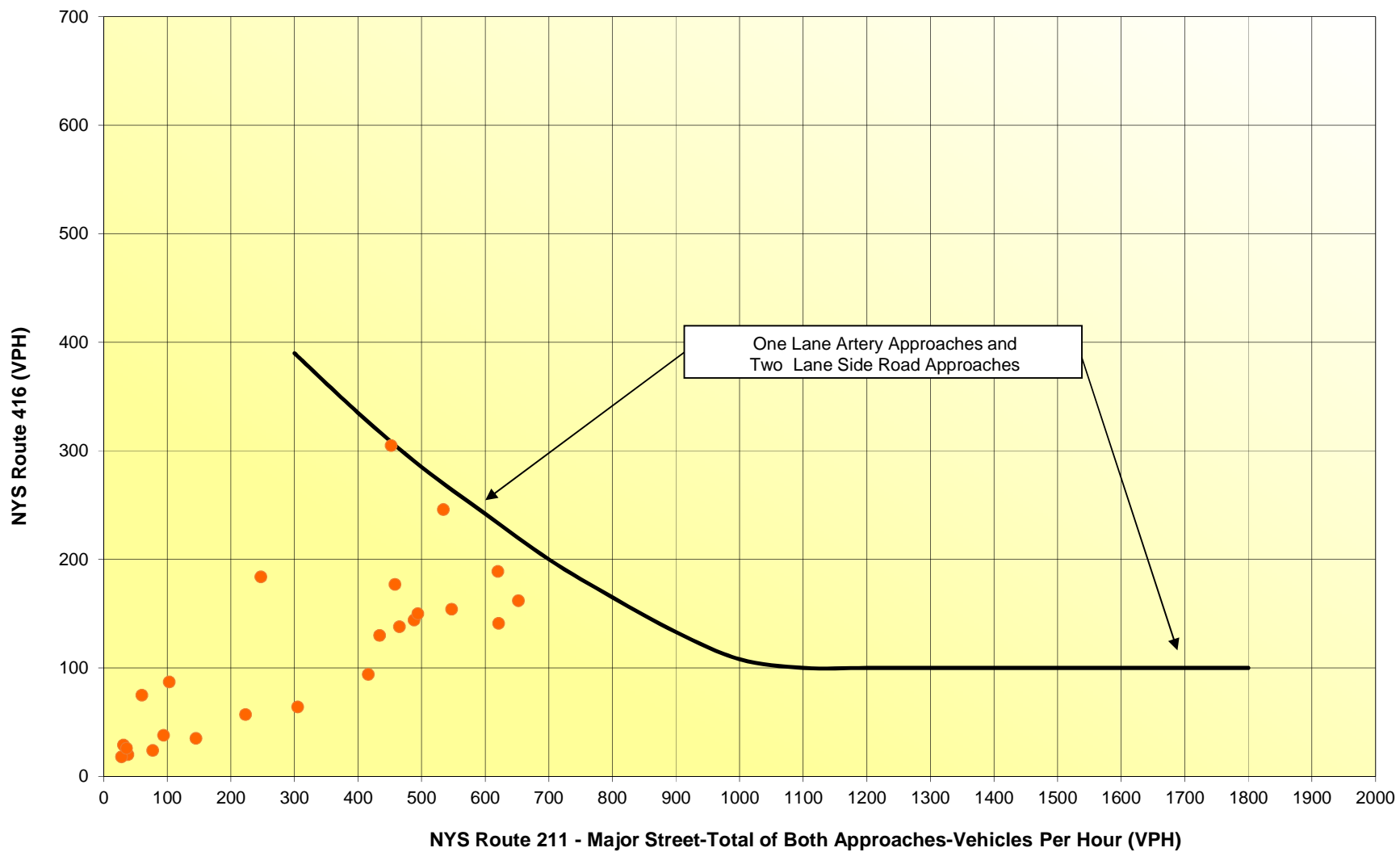

Attachment E

Left-Turn Lane Warrant Analysis

**Traffic Impact Assessment
KSH Development
Village of Montgomery, New York**

Suggested Left-Turn Lane Warrants Based on Results from Benefit-Cost Evaluations for Intersections on Arterials in Urban Areas
AASHTO Figure 9-35 (Table 9-24)

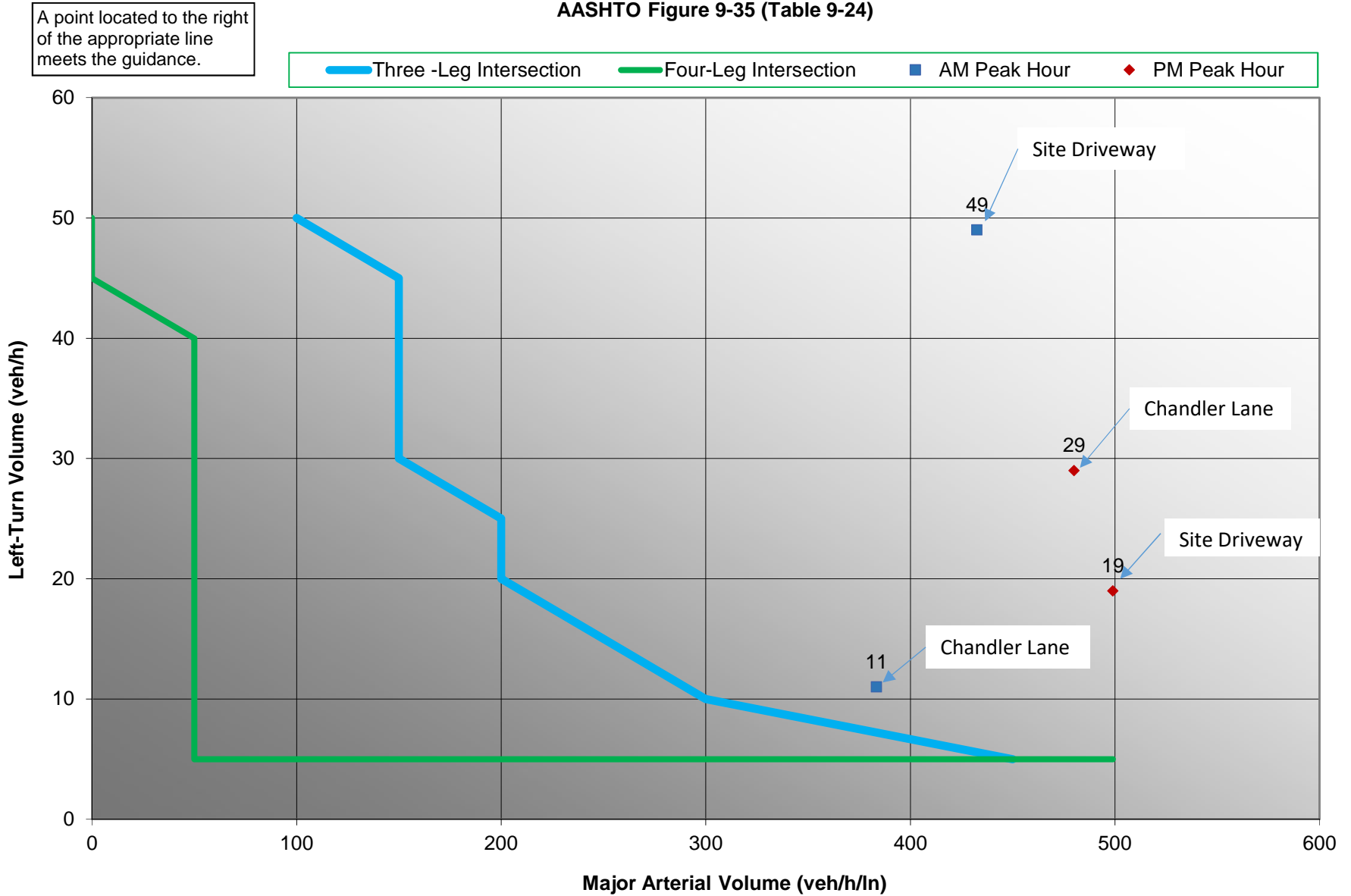

Source: A Policy on Geometric Design of Highways and Streets, 2011, Table 9-23

N:\Projects\2019\119-036 Engineering & Surveying Properties - KSH Development\Working\Analysis\Left-Turn Warrant\NYS Route 211-Site Driveway\AASHTO LTL Guidance (2018)